

# 晶体管相关配件

TRANSISTOR COVER

电子电脑塑胶五金零件

PLASTIC HARDWARE & ELECTRONIC COMPONENTS

2023 EDITON

晶体管盖 电晶体盖 晶体管垫片 电晶体垫片 晶体管座 电晶体座 T-O3晶体管座 石英晶体垫片 垫圈 华司 垫片 TO-220晶体管座 光电晶体座 电晶体座 IR晶体管座 霍尔晶体管座 硅胶帽套 功率晶体导热硅片 功率晶体压板 电源固定压条 晶体管固定弹片 五金弹片 电晶体固定弹片 晶体管夹

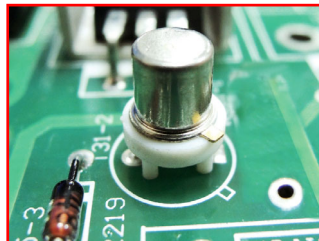
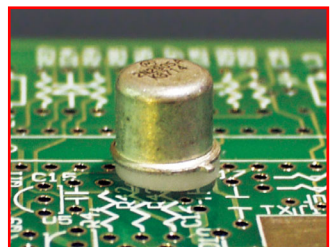
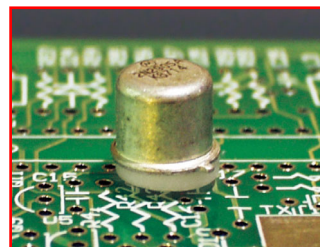
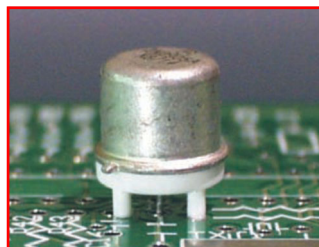
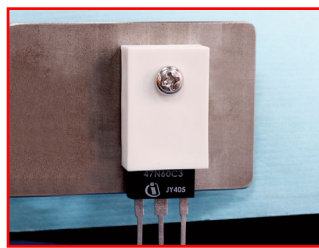
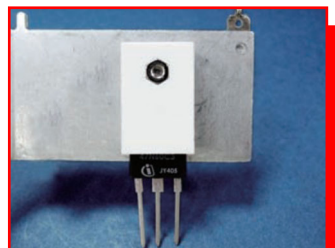
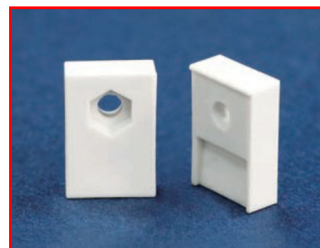
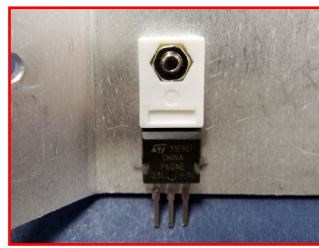
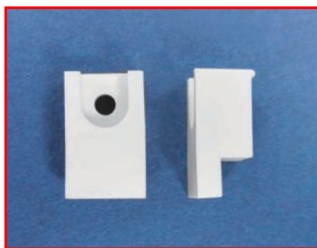
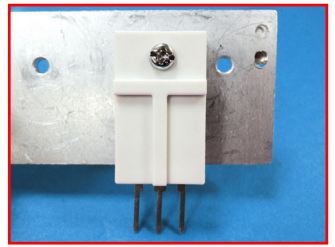
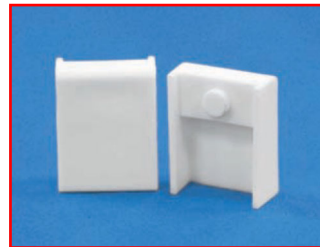
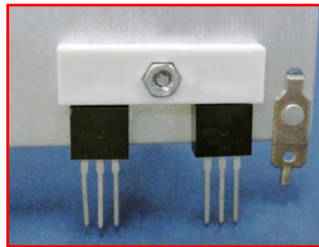
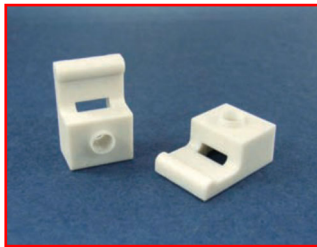
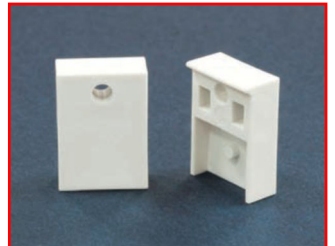
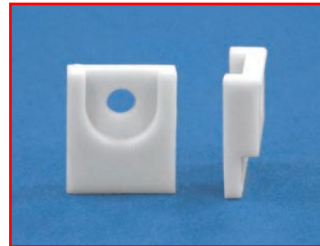
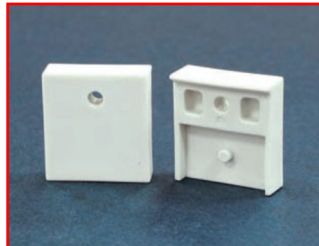
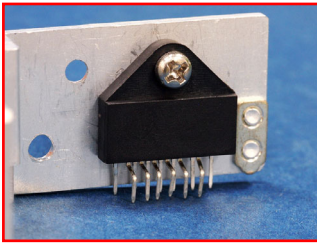
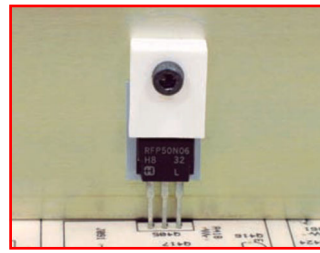

晶体管盖/垫片



晶体管盖 电晶体盖 晶体管垫片 电晶体垫片 晶体管座 电晶体座 T-O3晶体管座 石英晶体垫片 垫圈 华司 垫片 TO-220晶体管座 光电晶体座 电晶体座 IR晶体管座 霍尔晶体管座 硅胶帽套 功率晶体导热硅片 功率晶体压板 电源固定压条 晶体管固定弹片 五金弹片 电晶体固定弹片 晶体管夹

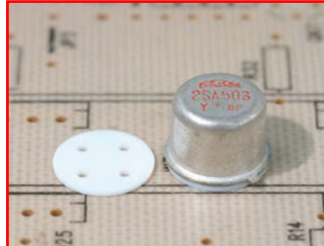
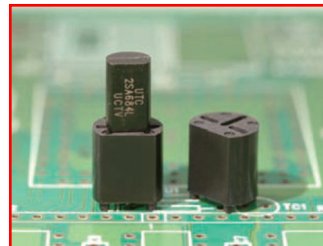
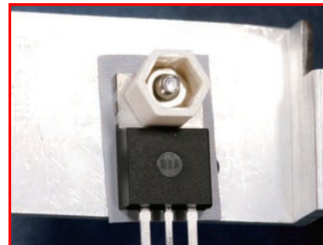
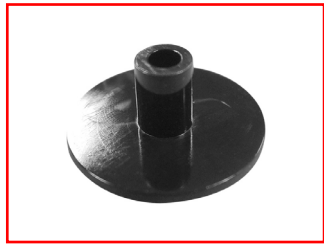
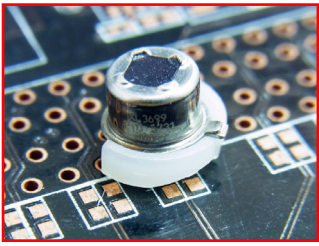

晶体管垫片

晶体管盖 电晶体盖 晶体管垫片 电晶体垫片 晶体管座 电晶体座 T-O3晶体管座 石英晶体垫片 垫圈 华司 垫片 TO-220晶体管座 光电晶体座 电晶体座 IR晶体座 霍尔晶体座 硅胶帽套 功率晶体导热硅片 功率晶体压板 电源固定压条 晶体管固定弹片 五金弹片 电晶体固定弹片 晶体管夹

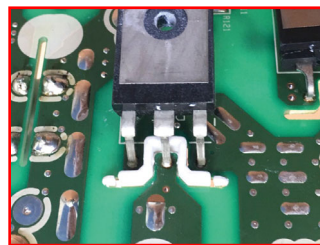
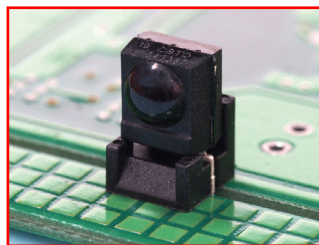
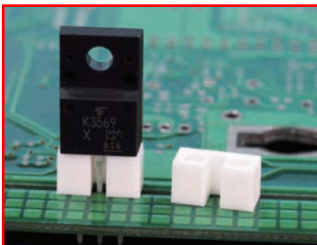
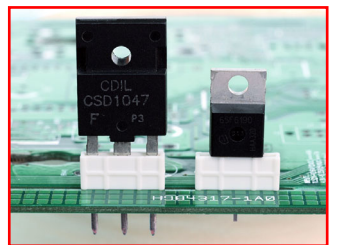
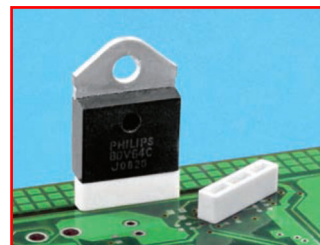
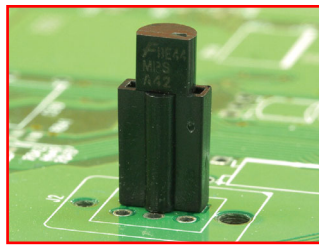
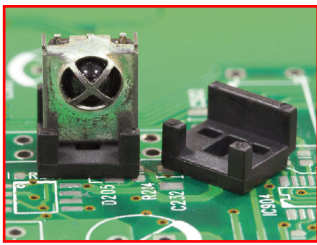
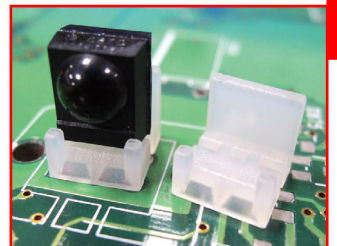
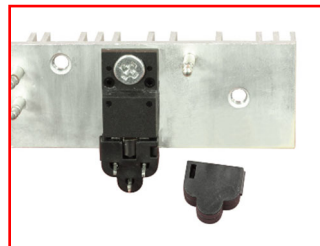
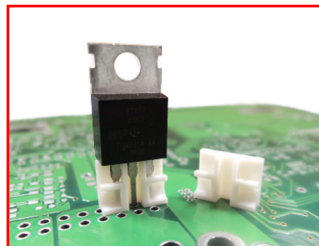
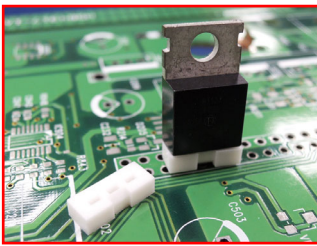
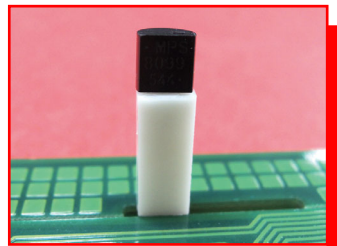
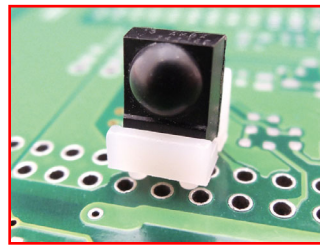
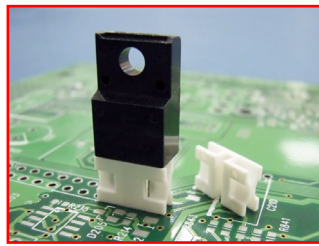
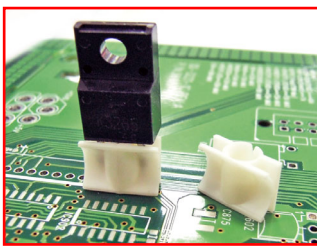
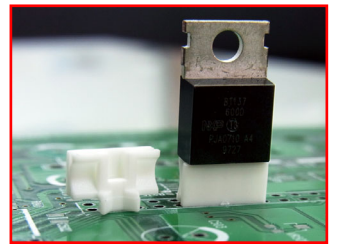
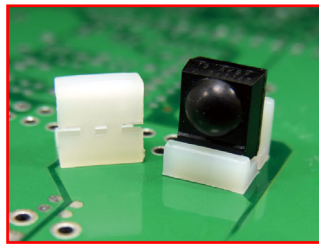
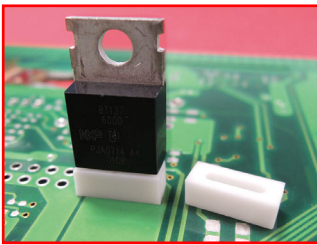
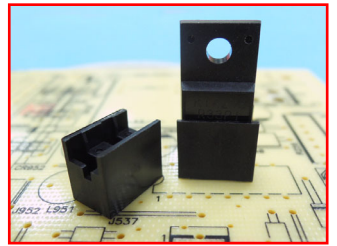
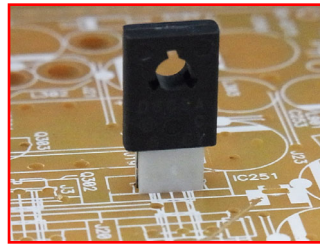
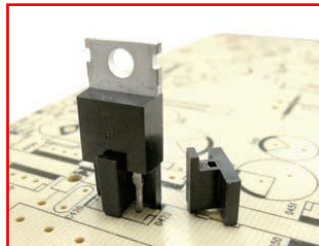
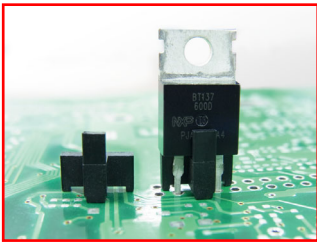
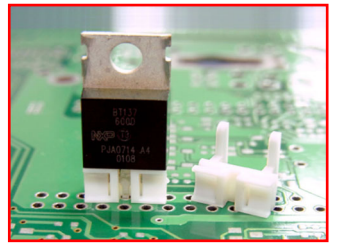
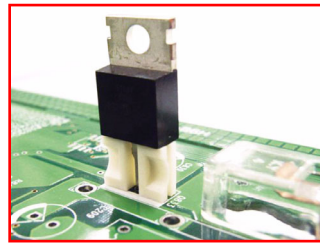
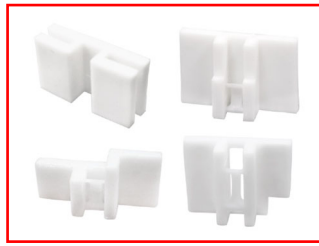
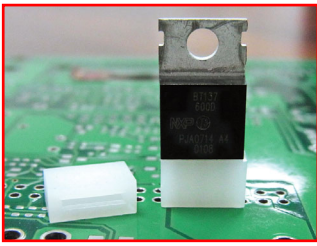

晶体管盖/垫片



晶体管盖 电晶体盖 晶体管垫片 电晶体垫片 晶体管座 电晶体座 T-O3晶体管座 石英晶体垫片 垫圈 华司 垫片 TO-220晶体管座 光电晶体座 电晶体座 IR晶体管座 霍尔晶体管座 硅胶帽套 功率晶体导热硅片 功率晶体压板 电源固定压条 晶体管固定弹片 五金弹片 电晶体固定弹片 晶体管夹

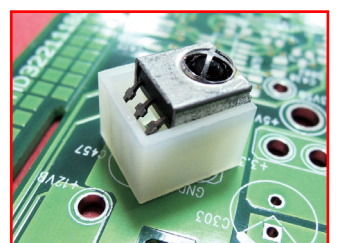
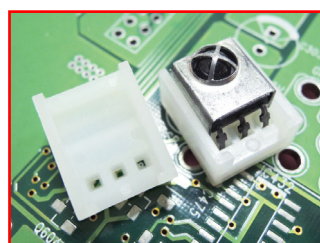
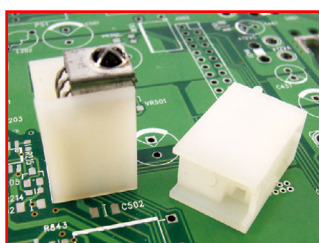
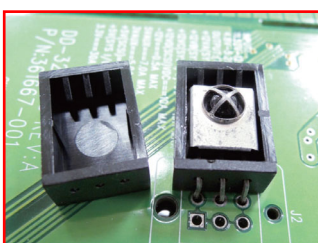
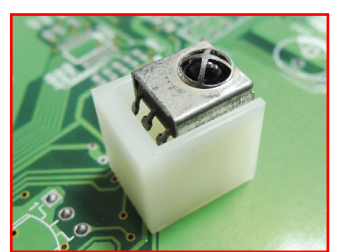
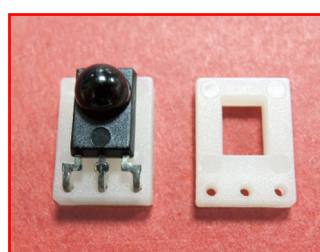
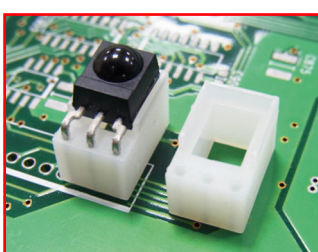
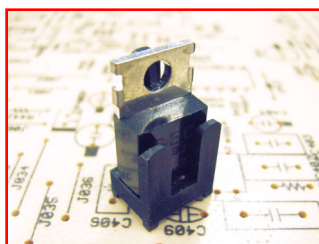
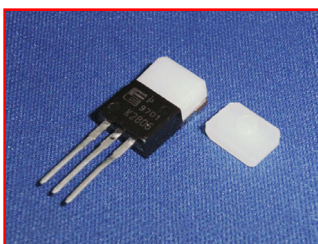
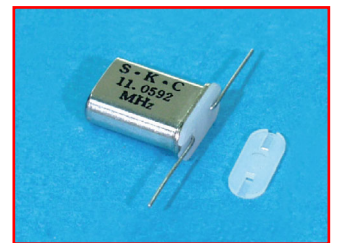
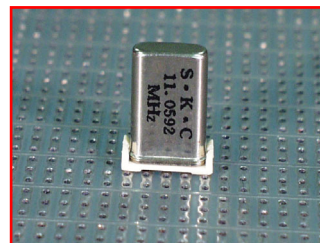
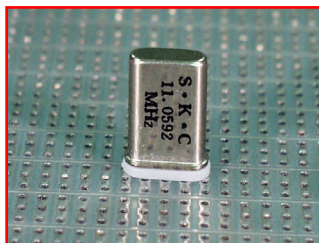
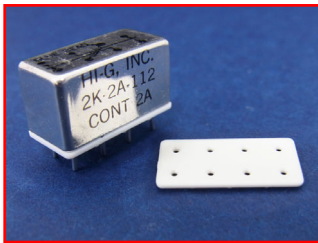
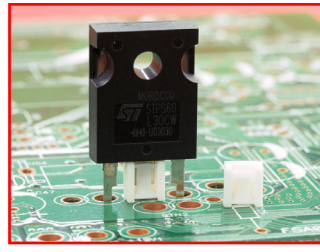
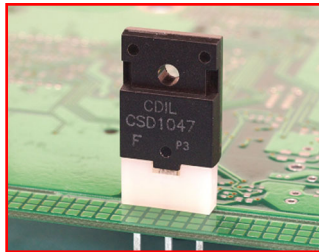

晶体管垫片/座



晶体管盖 电晶体盖 晶体管垫片 电晶体垫片 晶体管座 电晶体座 T-O3晶体管座 石英晶体垫片 垫圈 华司 垫片 TO-220晶体管座 光电晶体座 电晶体座 IR晶体管座 霍尔晶体管座 硅胶帽套 功率晶体导热硅片 功率晶体压板 电源固定压条 晶体管固定弹片 五金弹片 电晶体固定弹片 晶体管夹

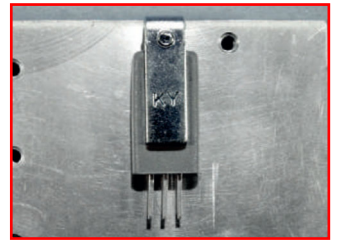
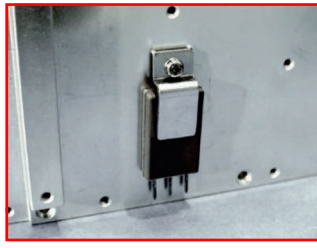
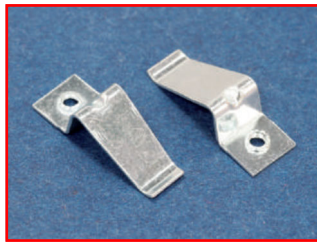
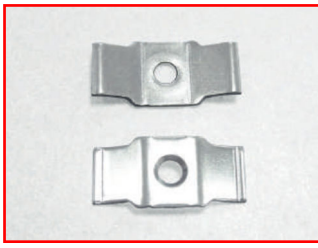
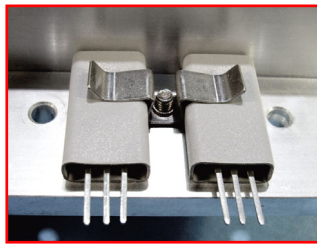
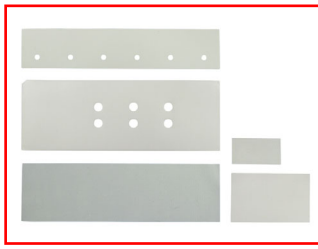
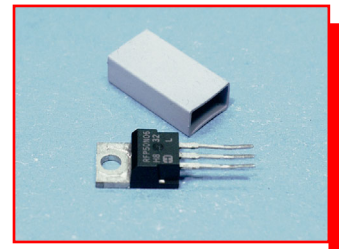
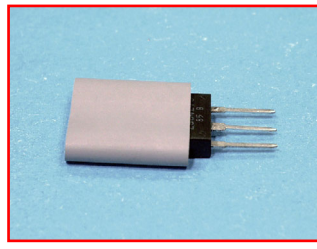
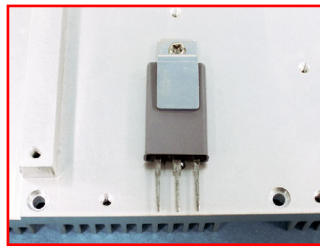
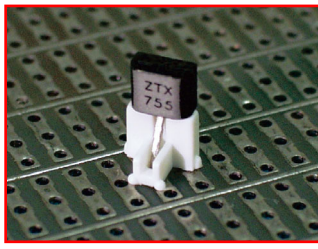
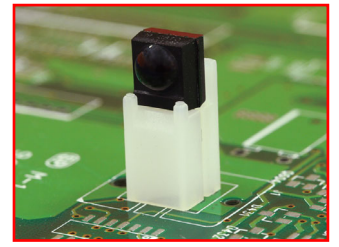
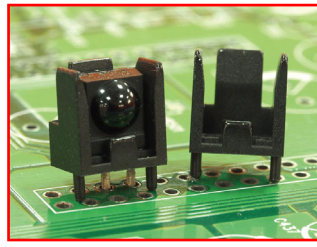
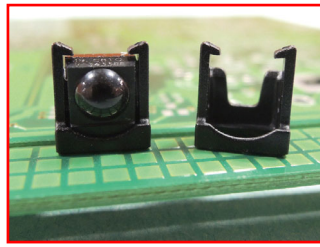
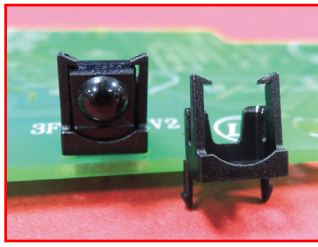
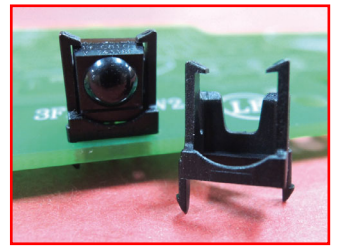
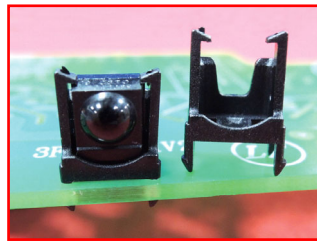
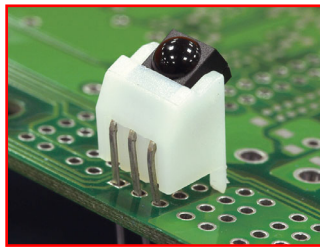
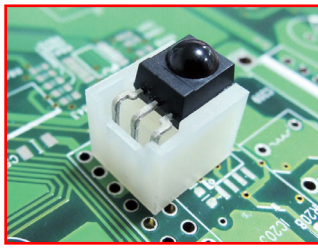
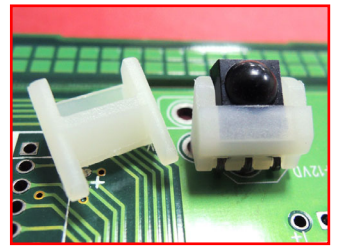
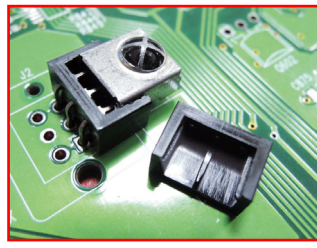
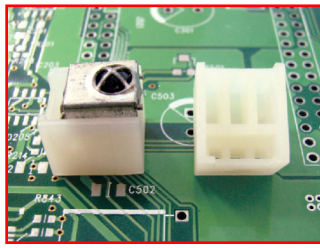
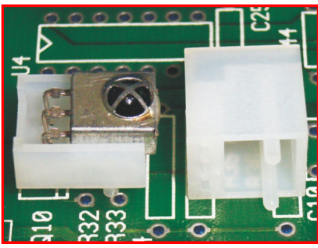

晶体管座/功率晶体压板



晶体管盖 电晶体盖 晶体管垫片 电晶体垫片 晶体管座 电晶体座 T-O3晶体管座 石英晶体垫片 垫圈 华司 垫片 TO-220晶体管座 光电晶体座 电晶体座 IR晶体座 霍尔晶体座 硅胶帽套 功率晶体导热硅片 功率晶体压板 电源固定压条 晶体管固定弹片 五金弹片 电晶体固定弹片 晶体管夹

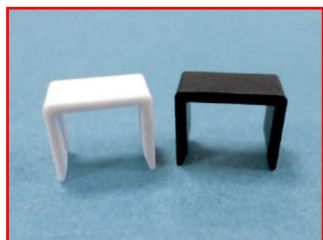
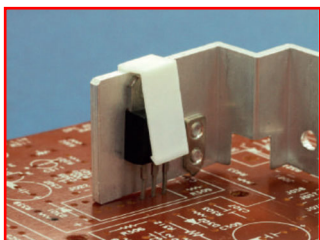

功率晶体压板

# 晶体管盖 TRNASTOR COVER 电晶体盖



- ◆ BODY MATERIAL : NYLON 66 (UL)/PPS(UL)
- ◆ FLAME CLASS : 94V-2,94V-0
- ◆ CLIP MATERIAL : SUS
- ◆ COLOR : BLACK
- ◆ UNIT: mm

用途：晶体管盖，也称电晶体盖，锁于散热片上之晶体外壳，绝缘性特佳，防止高压跳火，耐高温，提高可靠度，增进美观。

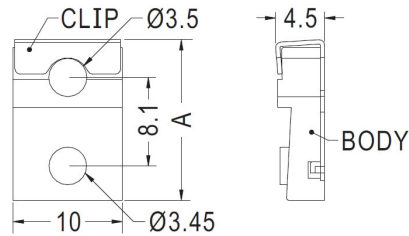

PART NO	A	PACKAGE
DTZ-1	14.5	1000
DTZ-48	14.7	1000



- ◆ BODY MATERIAL : PPS(UL)
- ◆ FLAME CLASS : 94V-0
- ◆ CLIP MATERIAL : SUS
- ◆ COLOR : BLACK
- ◆ UNIT: mm

用途：晶体管盖，也称电晶体盖，用于TO-220功率晶体，锁于散热片上之晶体外壳，绝缘性特佳，防止高压跳火，耐高温，提高可靠度，增进美观。

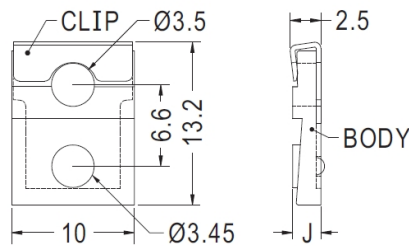

PART NO	A	PACKAGE
TO-220-9	2.1	1000
TO-220-10	2.2	1000

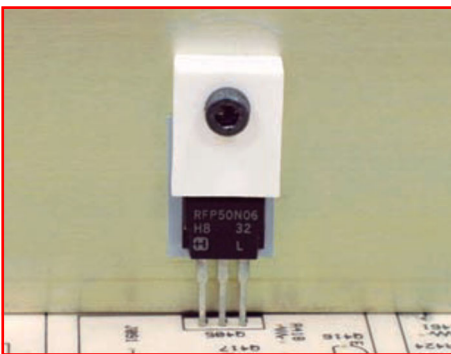

- ◆ MATERIAL : PTB(UL)/NYLON 66(UL)
- ◆ FLAME CLASS : 94V-0/94V-2
- ◆ COLOR : BLACK/NATUAL
- ◆ UNIT: mm

用途：晶体管盖，也称电晶体盖，锁于散热片上之晶体外壳，绝缘性特佳，防止高压跳火，耐高温，提高可靠度，增进美观。

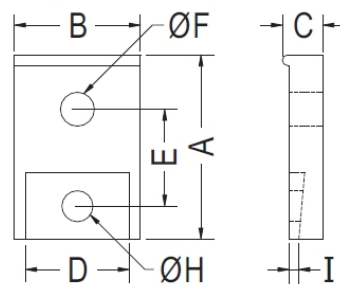

PART NO	A	B	C	D	E	F	H	I	适用晶体	PACKAGE
LTC001	16.0	13.0	6.2	10.7	8.0	3.5	3.4	0.8	TO-220	500
LTC002	19.3	13.0	6.2	10.7	10.0	3.6	3.2	0.8	TO-220	500
LTC003	17.8	13.0	6.3	10.7	9.3	3.5	3.3	0.9	TO-220	500
LTC004	19.0	18.0	8.0	16.0	10.5	3.5	3.5	1.0	TO-218	500
LTC015	22.5	13.0	6.3	10.5	15.0	3.5	3.5	0.8	TO-220	500
LTC016	16.0	13.0	6.2	10.7	8.0	3.5	3.5	0.5	TO-220	500
LTC017	30.0	18.0	8.0	15.7	17.0	3.6	2.8	2.0	TO-3P	200



# 晶体管盖 TRNASTOR COVER 电晶体盖



- ◆ MATERIAL : PTB(UL)/NYLON 66(UL) 用途: 晶体管盖, 也称电晶体盖, 锁于散热片上之晶体外壳,
- ◆ FLAME CLASS : 94V-0/94V-2 绝缘性特佳, 防止高压跳
- ◆ COLOR : BLACK/NATUAL 火, 耐高温, 提高可靠度,
- ◆ UNIT: mm 增进美观。

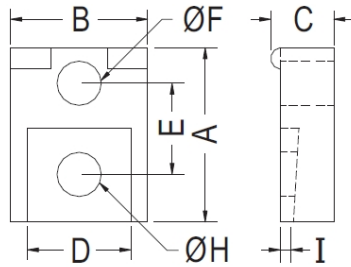

PART NO	A	B	C	D	E	F	H	I	适用晶体	PACKAGE
LTC008	13.0	13.2	6.2	10.7	6.8	3.3	3.3	0.8	TO-220	500
LTC009	13.0	13.2	7.0	10.7	6.8	3.3	3.0	2.1	TO-220	500
LTC012	14.3	13.2	6.2	10.5	8.2	3.3	3.2	1.0	TO-220	500
LTC013	14.3	13.2	7.0	10.7	8.2	3.3	2.7	2.1	TO-220	500
LTC019	13.0	13.2	6.7	10.7	7.1	3.3	2.8	2.0	TO-220	500
LTC037	14.3	13.2	6.2	10.5	8.2	3.3	3.2	0.5	TO-220	500

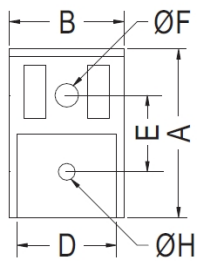

LTC005

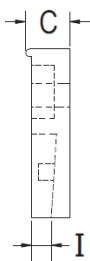

LTC006

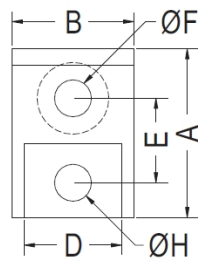

LTC007

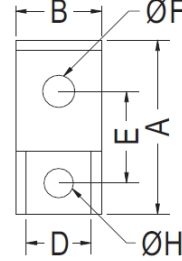

LTC010

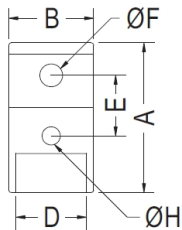

LTC011

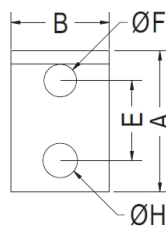

LTC014

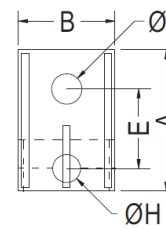

LTC018

PART NO	A	B	C	D	E	F	H	I	适用晶体	PACKAGE
LTC005	28.0	19.0	8.8	16.5	12.8	3.9	2.9	4.0	TO-3P	200
LTC006	16.0	13.0	6.2	10.7	8.0	3.5	3.5	0.8	TO-220	1000
LTC007	16.0	13.0	6.2	10.5	8.0	3.5	3.5	0.8	TO-220	500
LTC010	20.0	25.4	7.0	22.5	12.7	3.3	-	2.6	整流器	500
LTC011	23.0	12.9	8.3	10.8	9.3	3.5	2.8	1.0	TO-220	500
LTC014	14.3	10.0	4.2	-	8.1	3.3	3.5	0.8	-	500
LTC018	17.7	12.1	5.6	-	10.0	3.8	3.5	0.7	-	500

# 晶体管盖 TRNASTISOR COVER 电晶体盖

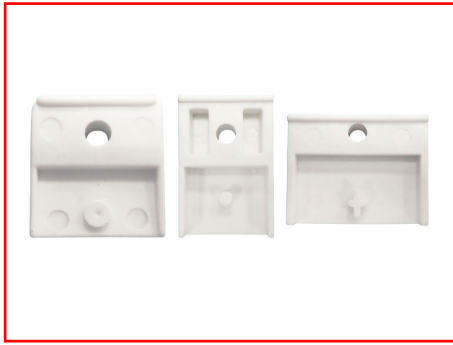

- ◆ MATERIAL : PTB(UL)/NYLON 66(UL) 用途: 晶体管盖, 也称电晶体盖, 锁于散热片上之晶体外壳,
- ◆ FLAME CLASS : 94V-0/94V-2 绝缘性特佳, 防止高压跳
- ◆ COLOR : BLACK/NATUAL 火, 耐高温, 提高可靠度,
- ◆ UNIT: mm 增进美观。

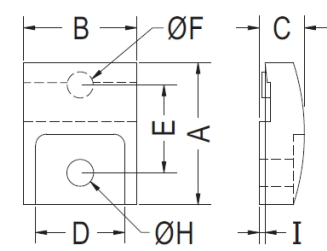

LTC020

LTC024

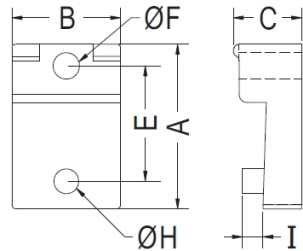

LTC021

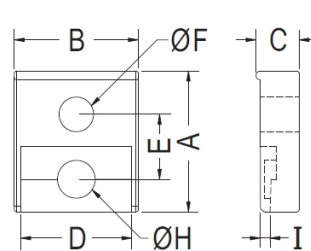

LTC022

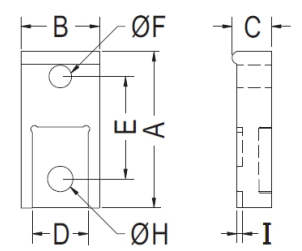

LTC023

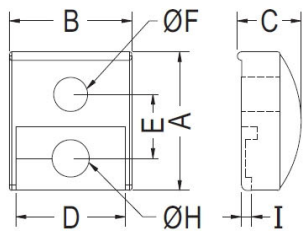

LTC038

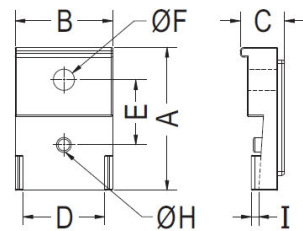

LTC045

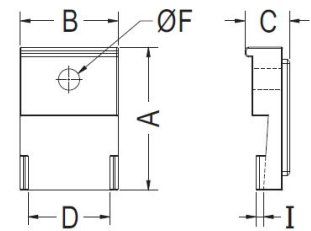

LTC046

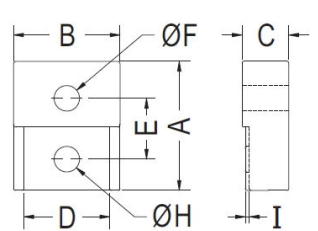

LTC047

PART NO	A	B	C	D	E	F	H	I	适用晶体	PACKAGE
LTC020	19.1	15.2	6.1	12.0	11.8	3.5	3.6	0.8	TO-218	500
LTC021	20.0	13.2	8.3	-	14.0	3.2	3.0	2.5	-	500
LTC022	13.0	11.5	4.0	10.3	6.0	3.2	3.5	0.9	-	500
LTC023	21.55	10.8	5.4	8.3	14.1	3.1	3.5	0.75	-	500
LTC024	22.2	15.2	6.1	12.0	14.9	3.6	3.5	0.8	TO-218	500
LTC038	13.0	11.5	6.0	10.3	6.0	3.2	3.5	0.9	TO-220	500
LTC045	27.0	18.5	8.4	15.5	12.3	4.0	2.8	1.4	TO-3P	500
LTC046	27.0	18.5	8.4	15.5	-	4.0	-	1.4	TO-3P	500
LTC047	15.7	13.0	5.7	10.5	7.4	3.1	3.1	0.5	TO-220	500



## 晶体管盖 TRNASTISOR COVER 电晶体盖

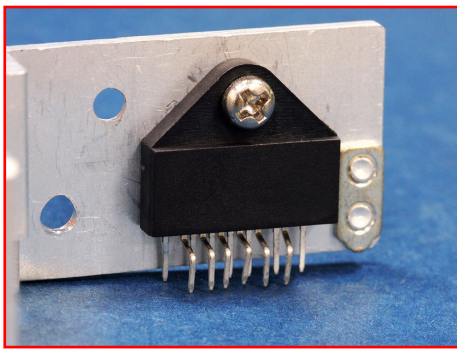

- ◆ MATERIAL : PTB (UL)
- ◆ FLAME CLASS : 94V-0
- ◆ COLOR : BLACK
- ◆ UNIT: mm

用途：晶体管盖，也称电晶体盖，锁于散热片上之功率IC外壳，绝缘性特佳，防止高压跳火，耐高温，提高可靠度，增进美观。

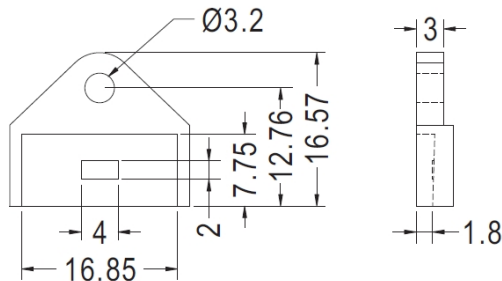

PART NO	PACKAGE
LTC025	1000



- ◆ MATERIAL : PBT (UL)
- ◆ FLAME CLASS : 94V-0
- ◆ COLOR : NATURAL
- ◆ UNIT: mm

用途：晶体管盖，也称电晶体盖，用于TO-264功率晶体，锁于散热片上之晶体外壳，绝缘性特佳，防止高压跳火，耐高温，提高可靠度，增进美观。

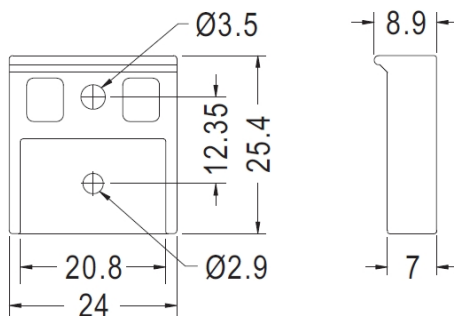

PART NO	PACKAGE
TO-264	1000

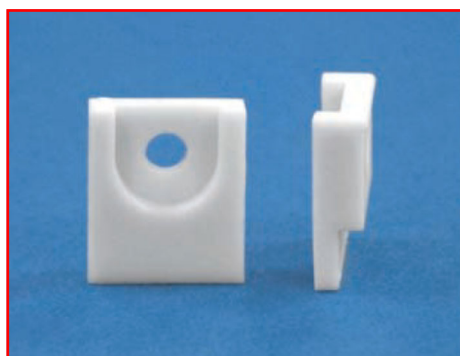

- ◆ MATERIAL : NYLON 66 (UL)
- ◆ FLAME CLASS : 94V-0/94V-2
- ◆ COLOR : NATURAL
- ◆ UNIT: mm

用途：晶体管盖，也称电晶体盖，锁于散热片上之晶体外壳，绝缘性特佳，防止高压跳火，耐高温，提高可靠度，增进美观。

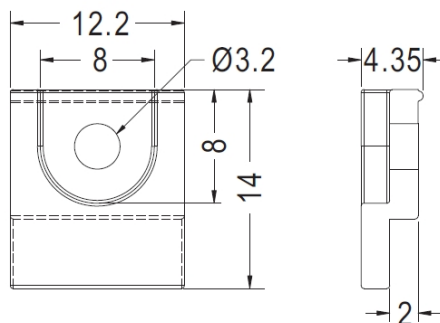

PART NO	PACKAGE
LTC027	1000

## 晶体管盖 TRNASTOR COVER 电晶体盖

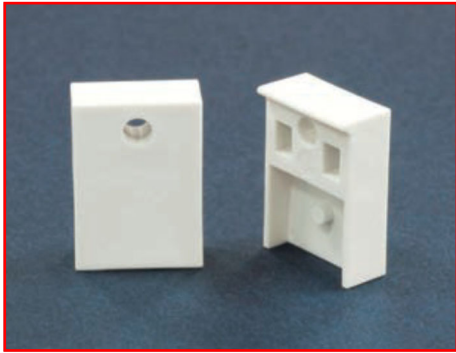

- ◆ MATERIAL : PTB (UL)
- ◆ FLAME CLASS : 94V-0
- ◆ COLOR : NATUAL
- ◆ UNIT: mm

用途：晶体管盖，也称电晶体盖，用于TO-247功率晶体，锁于散热片上之晶体外壳，绝缘性特佳，防止高压跳火，耐高温，提高可靠度，增进美观。

PART NO	E	I	PACKAGE
TO-247	14.1	1.8	200
TO-247-1	14.1	3.3	200
TO-247-2	16.5	3.3	200

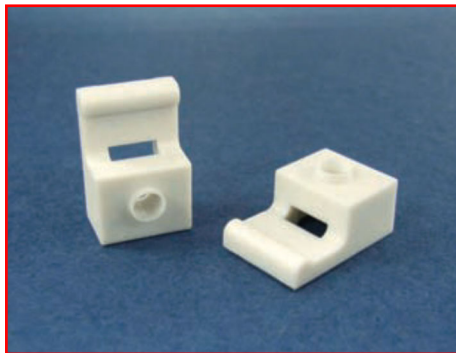
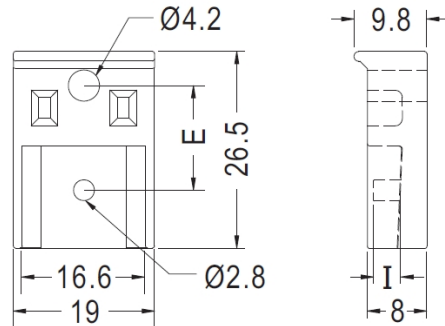

- ◆ MATERIAL : PBT (UL)
- ◆ FLAME CLASS : 94V-0
- ◆ COLOR : NATURAL
- ◆ UNIT: mm

用途：晶体管盖，也称电晶体盖，用于功率晶体之外壳绝缘。

PART NO	L	PACKAGE
LTC029	1.0	2000
LTC030	2.0	2000

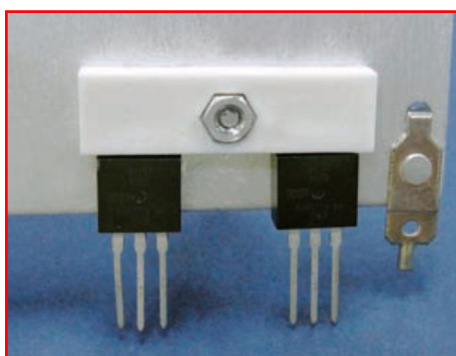
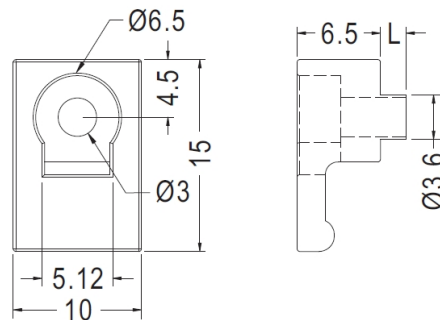

- ◆ MATERIAL : PBT (UL)
- ◆ FLAME CLASS : 94V-0
- ◆ COLOR : NATURAL
- ◆ UNIT: mm

用途：晶体管盖，也称电晶体盖，用于TO-220功率晶体，锁于散热片上之晶体外壳，绝缘性特佳，防止高压跳火，耐高温，提高可靠度，增进美观。

PART NO	E	I	PACKAGE
TO-220-7	33.5	20.5	1000
TO-220-8	34.3	21.7	1000

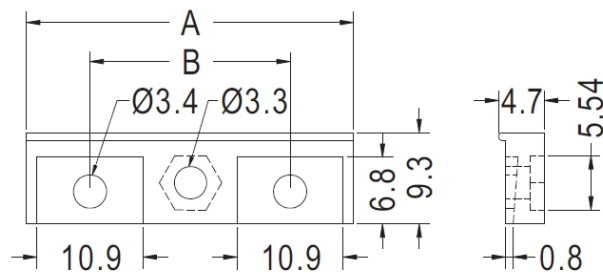

## 晶体管盖 TRNASTOR COVER 电晶体盖

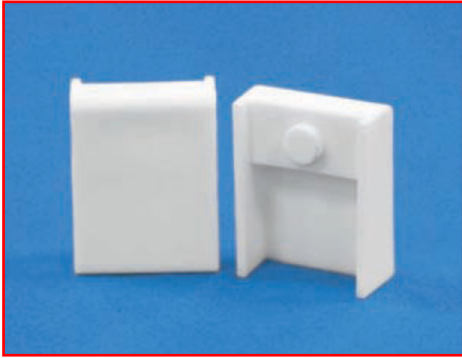

- ◆ MATERIAL : PTB (UL)
- ◆ FLAME CLASS : 94V-0
- ◆ COLOR : NATURAL
- ◆ UNIT: mm

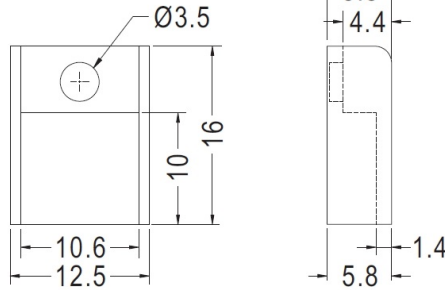

用途：晶体管盖，也称电晶体盖，用于TO-220功率晶体，锁于散热片上之晶体外壳，绝缘性特佳，防止高压跳火，耐高温，提高可靠度，增进美观。

PART NO	PACKAGE
TO-220-6	1000

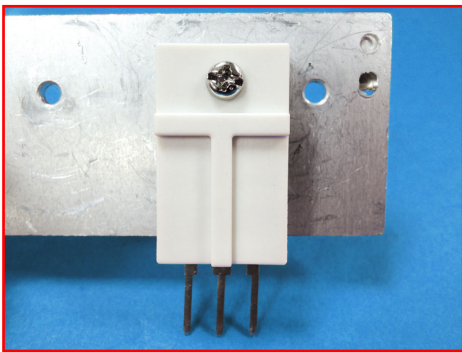

- ◆ MATERIAL : PBT (UL)
- ◆ FLAME CLASS : 94V-0
- ◆ COLOR : NATURAL
- ◆ UNIT: mm

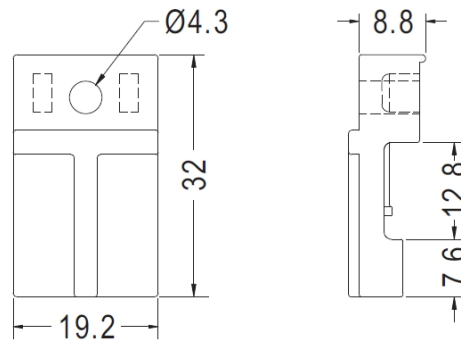

用途：晶体管盖，也称电晶体盖，锁于散热片上之晶体外壳，绝缘性特佳，防止高压跳火，耐高温，提高可靠度，增进美观。

PART NO	PACKAGE
LTC033	1000

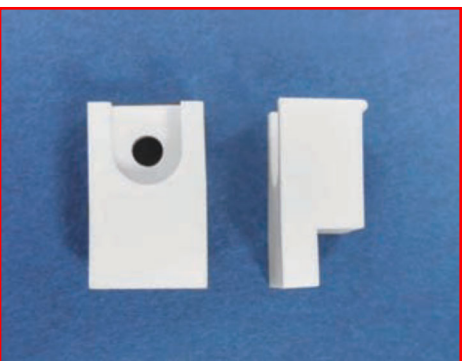

- ◆ MATERIAL : PBT (UL)
- ◆ FLAME CLASS : 94V-0
- ◆ COLOR : NATURAL
- ◆ UNIT: mm

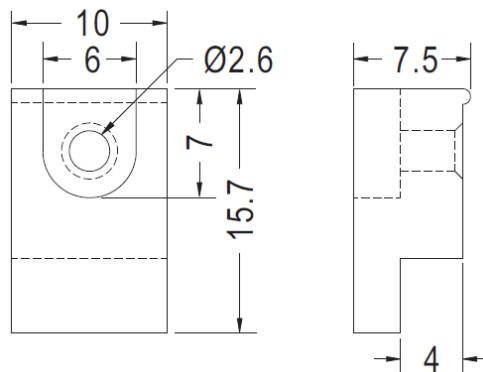

用途：晶体管盖，也称电晶体盖，锁于散热片上之晶体外壳，绝缘性特佳，防止高压跳火，耐高温，提高可靠度，增进美观。

PART NO	PACKAGE
LTC034	1000



# 晶体管盖 TRNASTOR COVER 电晶体盖

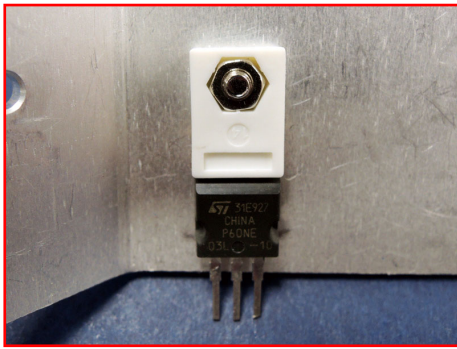

- ◆ MATERIAL : PTB
- ◆ COLOR : NATUAL
- ◆ UNIT: mm

用途：晶体管盖，也称电晶体盖，用于TO-220功率晶体，锁于散热片上之晶体外壳，绝缘性特佳，防止高压跳火，耐高温，提高可靠度，增进美观。

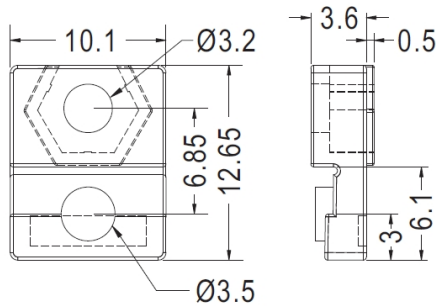

PART NO	PACKAGE
TO-220-4	1000

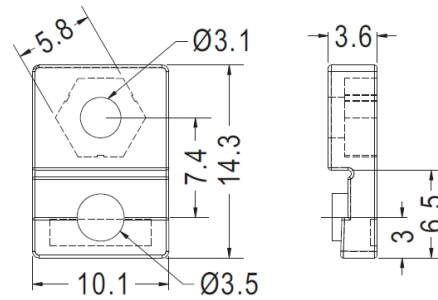

PART NO	PACKAGE
TO-220-5	1000

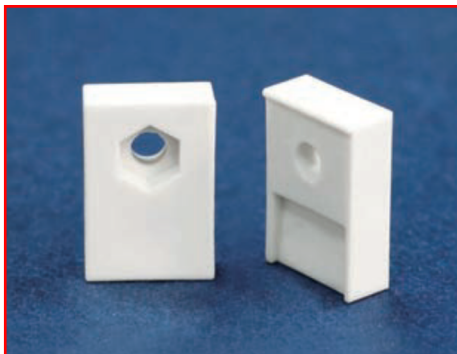

- ◆ MATERIAL : PBT (UL)
- ◆ FLAME CLASS : 94V-0
- ◆ COLOR : NATURAL
- ◆ UNIT: mm

用途：晶体管盖，也称电晶体盖，用于TO-220功率晶体，锁于散热片上之晶体外壳，绝缘性特佳，防止高压跳火，耐高温，提高可靠度，增进美观。

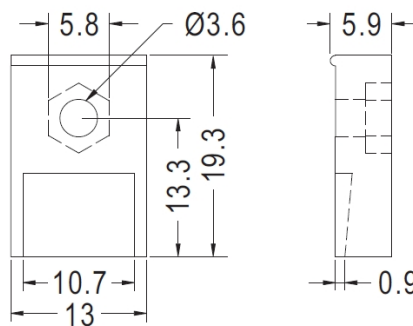

PART NO	PACKAGE
TO-220-3	1000

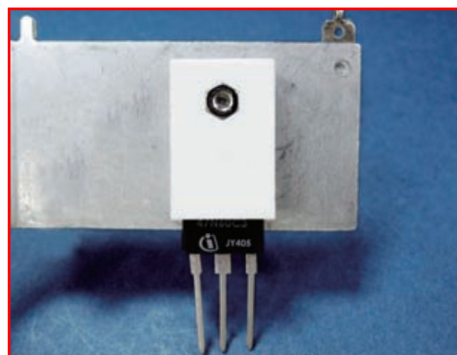

- ◆ MATERIAL : PBT (UL)
- ◆ FLAME CLASS : 94V-0
- ◆ COLOR : NATURAL
- ◆ UNIT: mm

用途：晶体管盖，也称电晶体盖，用于TP-3P功率晶体，锁于散热片上之晶体外壳，绝缘性特佳，防止高压跳火，耐高温，提高可靠度，增进美观。

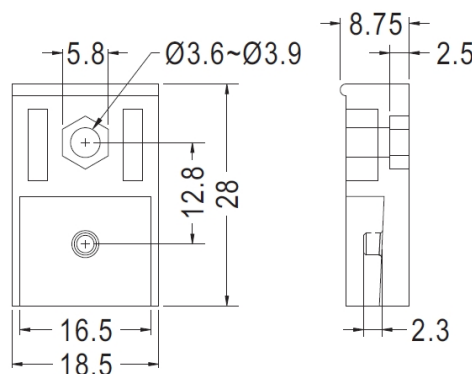

PART NO	PACKAGE
TP-3P	1000

## 晶体管盖 TRNASTISOR COVER 电晶体盖



- ◆ MATERIAL : PTB (UL)
- ◆ FLAME CLASS : 94V-0
- ◆ COLOR : NATURAL/BLACK
- ◆ UNIT: mm

用途：晶体管盖，也称电晶体盖，用于TO-220功率晶体，锁于散热片上之晶体外壳，绝缘性特佳，防止高压跳火，耐高温，提高可靠度，增进美观。

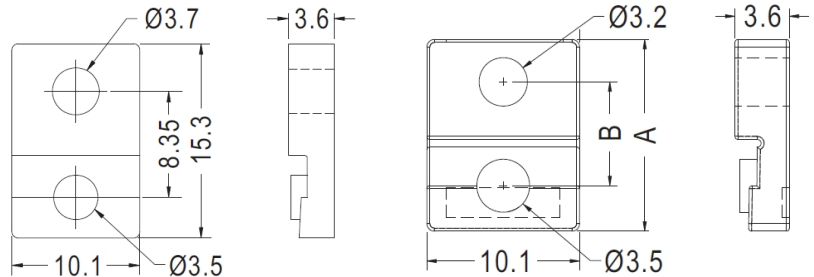

PART NO	PACKAGE
TO-220	1000

PART NO	A	B	PACKAGE
TO-220-1	12.65	6.85	1000
TO-220-2	11.45	5.65	1000

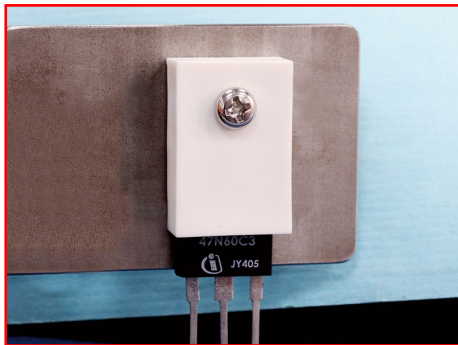

- ◆ MATERIAL : PBT (UL)
- ◆ FLAME CLASS : 94V-0
- ◆ COLOR : NATURAL
- ◆ UNIT: mm

用途：晶体管盖，也称电晶体盖，用于TO-3P功率晶体，锁于散热片上之晶体外壳，绝缘性特佳，防止高压跳火，耐高温，提高可靠度，增进美观。

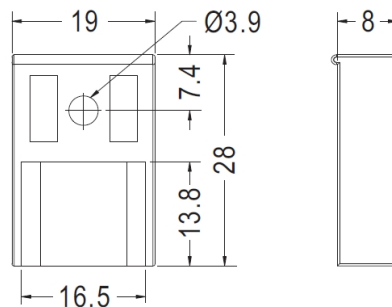

PART NO	PACKAGE
TO-3P-2	1000



- ◆ MATERIAL : NYLON 66 (UL)
- ◆ FLAME CLASS : 94V-0 / 94V-2
- ◆ COLOR : NATURAL
- ◆ UNIT: mm

用途：晶体管盖，也称电晶体盖，锁于散热片上之功率IC外壳，绝缘性特佳，防止高压跳火，耐高温，提高可靠度，增进美观。

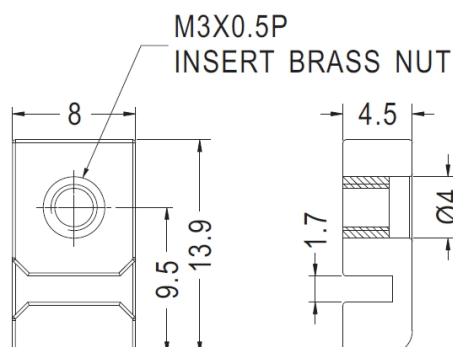

PART NO	PACKAGE
LTC051	1000

## 晶体管盖 TRNASTISOR COVER 电晶体盖



- ◆ MATERIAL : NYLON 66(UL)
- ◆ FLAME CLASS : 94V-2,94V-0
- ◆ CLIP MATERIAL : NICKEL PLATED
- ◆ COLOR : BLACK
- ◆ UNIT: mm

用途：晶体管盖，也称电晶体盖，用于 TO-3P功率晶体，保护晶体立于 PC板上，使接脚不弯曲、折断、短路，且高度一致。

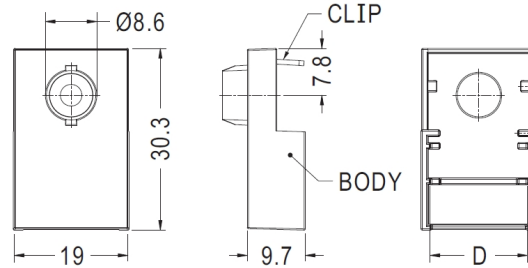

PART NO	L	PACKAGE
TO-3P	15.5	1000
TO-3P-1	15.8	1000

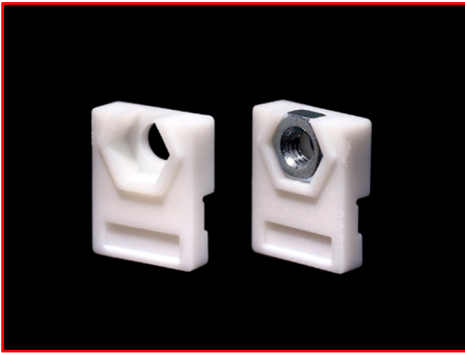

- ◆ MATERIAL : NYLON 66 (UL)
- ◆ FLAME CLASS : 94V-0 / 94V-2
- ◆ COLOR : NATURAL
- ◆ UNIT: mm

用途：晶体管盖，也称电晶体盖，用于 TO-220功率晶体，锁于散热片上之晶体外壳，绝缘性特佳，防止高压跳火，耐高温，提高可靠度，增进美观。

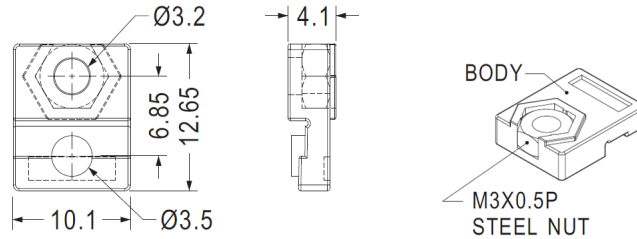

PART NO	PACKAGE
TO-220-11	1000





# 晶体管垫片 TRNASISTOR WASHER 垫圈 绝缘粒 塑料垫片 华司 电晶体垫片

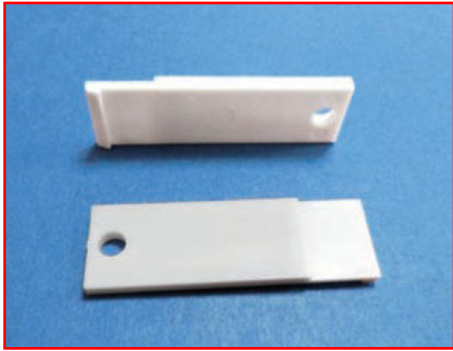

- ◆ MATERIAL : PBT (UL)
- ◆ FLAME CLASS : 94V-0
- ◆ COLOR : NATURAL
- ◆ UNIT: mm

用途：晶体管垫片，也称电晶体垫片，用于功率晶体之固定。

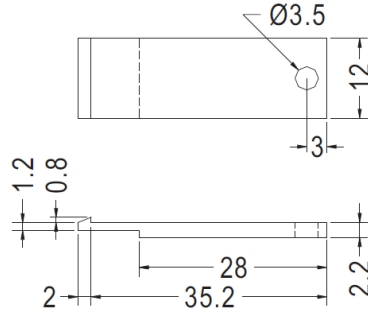

PART NO	PACKAGE
TORC-1	1000

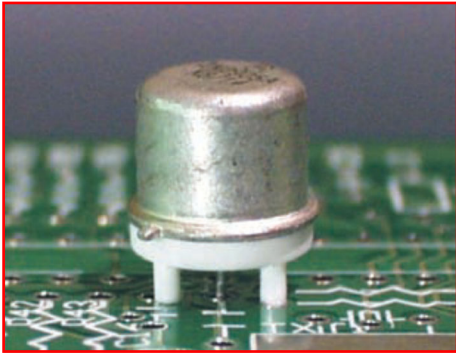

- ◆ MATERIAL : PBT (UL)
- ◆ FLAME CLASS : 94V-0
- ◆ COLOR : NATURAL
- ◆ UNIT: mm

用途：晶体管垫片，也称电晶体垫片，保护TO-05晶体立于PC板上，使接脚不弯曲、折断、短路、且高度一致，增加可靠度。

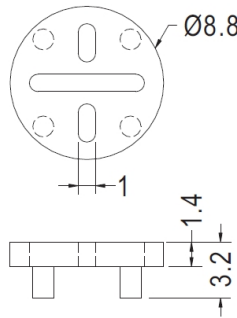

PART NO	PACKAGE
TO-05	1000

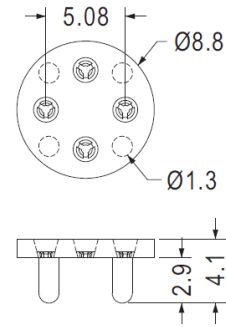

PART NO	PACKAGE
TO-05C	1000

晶体管垫片

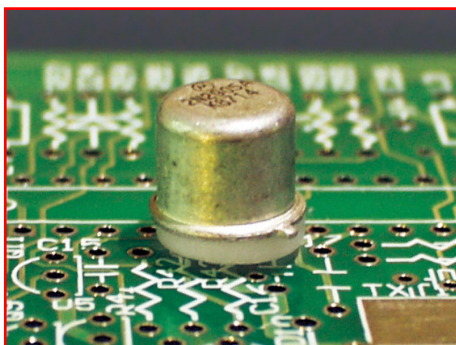

- ◆ MATERIAL : NYLON 66 (UL)
- ◆ FLAME CLASS : 94V-0/94V-2
- ◆ COLOR : NATURAL/BLACK
- ◆ UNIT: mm

用途：晶体管垫片，也称电晶体垫片，保护TO-05晶体立于PC板上，使接脚不弯曲、折断、短路、且高度一致，增加可靠度。

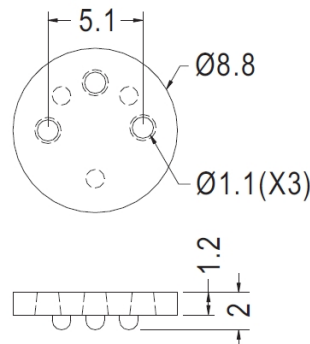

PART NO	PACKAGE
TO-05S	2000

# 晶体管垫片 TRNASTOR WASHER 垫圈 绝缘粒 塑料垫片 华司 电晶体垫片



- ◆ MATERIAL : NYLON 66 (UL)
- ◆ FLAME CLASS : 94V-0/94V-2
- ◆ COLOR : NATURAL/BLACK
- ◆ UNIT: mm

用途：晶体管垫片，也称电晶体垫片，保护晶体立于PC板上，高度一致，不断脚。

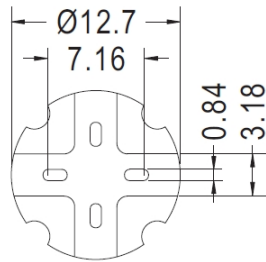

PART NO	PACKAGE
TORC-7	1000

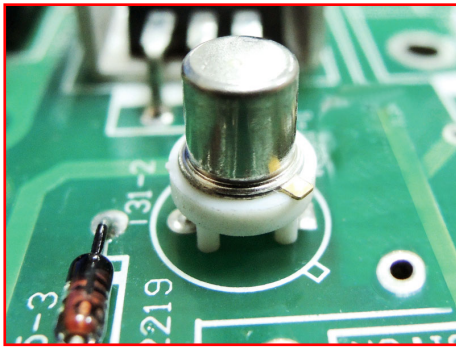

- ◆ MATERIAL : PBT(UL)/NYLON 66(UL)
- ◆ FLAME CLASS : 94V-0/94V-2
- ◆ COLOR : NATURAL/BLACK
- ◆ UNIT: mm

用途：晶体管垫片，也称电晶体垫片，保护TO-18晶体立于PC板上，使接脚不弯曲、折断、短路、且高度一致，增加可靠度。

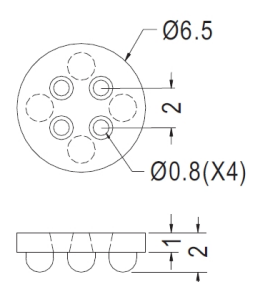
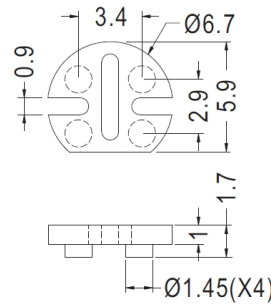
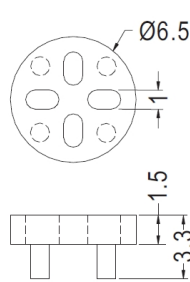

PART NO	PACKAGE
TO-18	1000

PART NO	PACKAGE
TO-18S	1000

PART NO	PACKAGE
TO-18M	1000



- ◆ MATERIAL : NYLON 66(UL)
- ◆ FLAME CLASS : 94V-0/94V-2
- ◆ COLOR : NATURAL/BLACK
- ◆ UNIT: mm

用途：晶体管垫片，也称电晶体垫片，保护TO-92功率晶体立于PC板上，高度一致，不断脚。

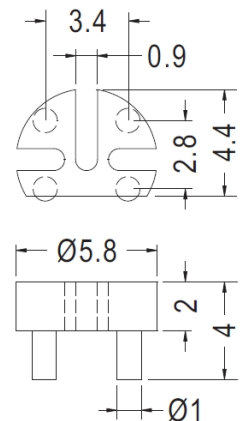
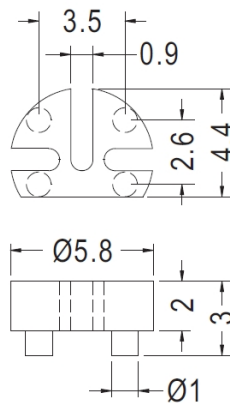

PART NO	PACKAGE
TO-92	2000

PART NO	PACKAGE
TO-92-1	2000



# 晶体管垫片 TRNASTOR WASHER 垫圈 绝缘粒 塑料垫片 华司 电晶体垫片

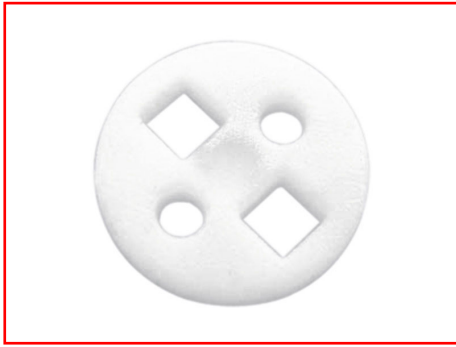

- ◆ MATERIAL : NYLON 66 (UL)
- ◆ FLAME CLASS : 94V-0/94V-2
- ◆ COLOR : NATURAL/BLACK
- ◆ UNIT: mm

用途：晶体管垫片，也称电晶体垫片，保护晶体立于PC板上，使接脚不弯曲、不断、不短路，且高度一致，增加可靠度。

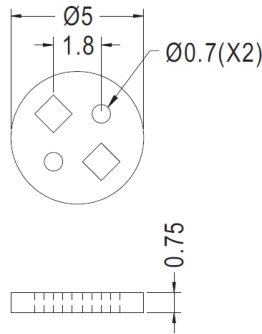

PART NO	PACKAGE
TORC-10	2000

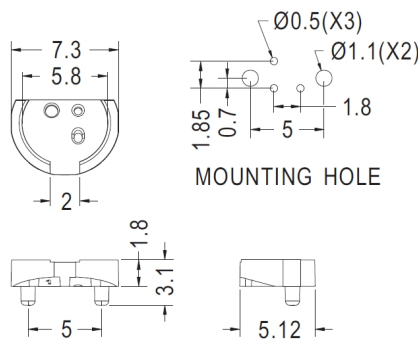
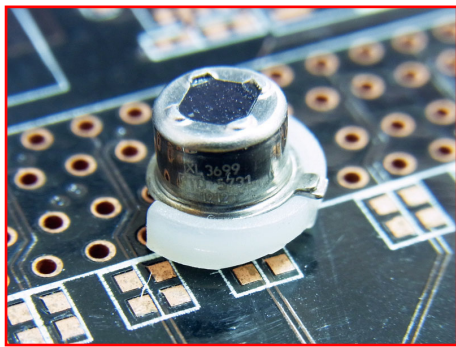

PART NO	PACKAGE
TORC-176	2000

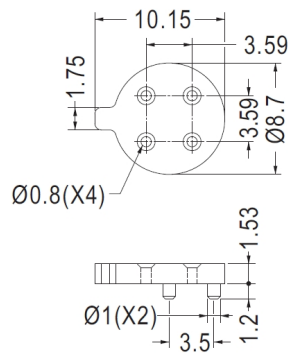

PART NO	PACKAGE
TORC-261	2000



- ◆ MATERIAL : NYLON 66 (UL)
- ◆ FLAME CLASS : 94V-0/94V-2
- ◆ COLOR : NATURAL/BLACK/WHITE
- ◆ UNIT: mm

用途：晶体管垫片，也称电晶体垫片，保护晶体立于PC板上，使接脚不弯曲、不断、不短路，且高度一致，增加可靠度。

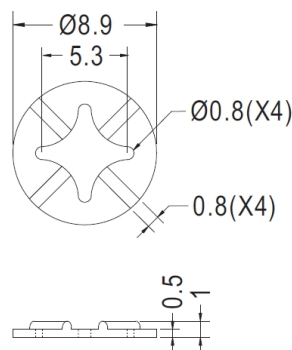

PART NO	PACKAGE
TORC-172	1000

# 晶体管垫片 TRNASTOR WASHER 垫圈 绝缘粒 塑料垫片 华司 电晶体垫片



- MATERIAL : PBT/PC V-2/PC V-0/ 用途: 晶体管垫片, 也称电晶体垫片,  
 ◆ POM/N46 V-0/N6 V-2/N66 V-2/ 锁于晶体管上, 避免晶体外壳与  
 N66 V-0 散热片间造成短路。  
 ◆ FLAME CLASS : 94V-0/94V-2  
 ◆ COLOR : NATURAL/BLACK  
 ◆ UNIT: mm

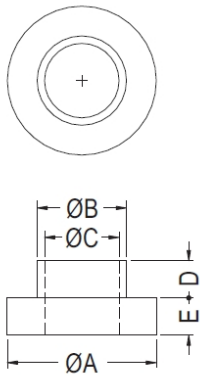

PART NO	A	B	C	D	E	PACKAGE
TORC-25	6.1	3.5	3.0	1.6	1.4	2000
TORC-26	6.1	3.55	3.0	1.5	2.0	2000
TORC-27	6.35	5.15	3.5	1.6	0.6	2000
TORC-29	6.5	3.5	3.0	4.0	0.9	2000
TORC-30	7.0	5.0	3.0	5.8	2.0	2000
TORC-31	11.9	7.9	4.0	3.0	2.6	2000
TORC-32	7.1	5.0	3.0	2.3	2.0	2000
TORC-33	6.4	3.55	2.95	2.0	1.3	2000
TORC-34	7.92	4.83	3.05	0.8	1.14	2000
TORC-35	6.0	3.6	3.0	5.2	1.0	2000
TORC-36	6.0	3.55	2.95	1.4	1.4	2000
TORC-37	14.0	7.5	6.0	1.8	1.2	2000
TORC-38	14.0	9.8	6.6	1.7	0.9	2000
TORC-39	16.0	11.4	10.0	0.8	0.7	2000
TORC-40	6.0	3.5	2.5	7.2	5.0	2000
TORC-41	6.0	3.5	2.5	11.0	5.0	2000
TORC-42	6.0	3.55	2.95	1.2	1.3	2000
TORC-43	15.7	9.7	4.5	6.5	5.0	2000
TORC-44	6.0	3.55	2.95	3.2	2.0	2000
TORC-45	6.1	3.5	2.95	1.5	1.1	2000
TORC-46	5.46	3.43	2.95	0.81	1.02	2000
TORC-47	6.6	4.95	2.6	6.0	1.5	2000
TORC-48	6.35	4.78	3.94	1.57	3.18	2000
TORC-49	25.4	11.0	8.3	2.29	1.58	1000
TORC-50	11.0	8.0	5.5	8.0	1.3	2000
TORC-51	6.4	3.53	3.0	2.0	1.2	2000
TORC-52	11.8	6.0	4.0	1.9	0.5	2000
TORC-53	10.0	4.3	3.45	3.0	1.0	2000
TORC-54	6.2	3.5	3.0	2.5	2.7	2000
TORC-55	6.2	3.5	3.0	2.5	2.0	2000
TORC-56	6.4	3.5	3.0	2.0	1.3	2000
TORC-57	6.0	3.5	3.0	3.2	2.0	2000

PART NO	A	B	C	D	E	PACKAGE
TORC-11	6.0	3.6	3.0	1.5	1.5	2000
TORC-12	6.2	3.5	3.0	3.0	1.5	2000
TORC-13	6.2	3.55	3.0	2.5	2.0	2000
TORC-14	6.0	3.5	3.0	2.0	2.0	2000
TORC-15	6.2	3.5	3.0	1.2	1.0	2000
TORC-16	6.2	3.5	3.0	1.4	1.2	2000
TORC-18	8.0	3.8	3.1	2.8	1.2	2000
TORC-19	10.0	6.0	5.0	5.0	1.0	2000
TORC-20	10.0	5.0	4.0	4.0	1.0	2000
TORC-21	9.5	6.3	4.5	1.2	1.2	1000
TORC-22	9.5	6.3	4.1	0.8	1.7	1000
TORC-23	9.9	8.3	6.5	1.5	1.0	1000
TORC-24	6.2	3.6	3.0	2.4	1.9	1000



# 晶体管垫片 TRNASTOR WASHER 垫圈 绝缘粒 塑料垫片 华司 电晶体垫片



- MATERIAL : PBT/PC V-2/PC V-0/ 用途: 晶体管垫片, 也称电晶体垫片,  
 ◆ POM/N46 V-0/N6 V-2/N66 V-2/ 锁于晶体管上, 避免晶体外壳与  
 N66 V-0 散热片间造成短路。  
 ◆ FLAME CLASS : 94V-0/94V-2  
 ◆ COLOR : NATURAL/BLACK  
 ◆ UNIT: mm

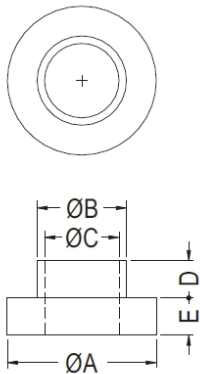

PART NO	A	B	C	D	E	PACKAGE
TORC-72	6.1	3.5	2.9	1.85	1.4	2000
TORC-73	6.0	3.5	3.0	2.3	1.8	2000
TORC-74	6.3	3.5	3.0	2.6	1.2	2000
TORC-75	9.0	3.5	3.0	3.5	1.0	2000
TORC-76	6.0	3.8	3.1	6.5	1.2	2000
TORC-77	6.1	3.5	3.0	2.1	1.4	2000
TORC-78	6.1	3.5	3.0	2.7	1.4	2000
TORC-79	12.7	6.7	4.3	1.5	1.46	2000
TORC-80	15.0	7.9	6.2	4.1	1.5	2000
TORC-82	9.5	6.5	5.1	10.7	1.5	2000
TORC-83	6.2	3.5	3.0	2.9	1.9	2000
TORC-84	6.4	3.5	3.0	2.0	1.2	2000
TORC-85	9.5	6.0	3.7	1.5	1.0	2000
TORC-86	6.0	3.4	2.7	2.5	1.0	2000
TORC-87	6.0	3.55	3.0	1.6	1.3	2000
TORC-88	6.3	3.5	3.0	2.6	2.0	2000
TORC-89	8.2	4.65	4.05	3.6	0.5	2000
TORC-90	6.2	3.5	3.0	4.1	2.0	2000
TORC-91	13.0	7.9	6.6	2.4	1.7	2000
TORC-92	6.2	3.55	3.0	0.6	1.2	2000
TORC-93	6.3	3.9	3.2	1.5	2.5	2000
TORC-94	12.0	8.0	3.0	3.0	1.4	2000
TORC-95	14.0	8.1	3.1	1.8	2.5	2000
TORC-96	7.6	3.5	3.1	4.0	2.0	2000
TORC-97	6.1	3.5	3.0	2.25	2.0	2000
TORC-98	6.1	3.5	3.0	0.8	2.0	2000
TORC-99	6.0	3.5	3.0	0.9	1.3	2000
TORC-100	6.2	3.5	3.0	4.6	2.0	2000
TORC-101	25.0	10.0	8.2	12.0	4.5	2000
TORC-102	4.0	2.7	2.1	0.7	0.8	2000
TORC-103	6.5	4.25	3.2	4.0	3.0	2000
TORC-104	13.0	6.5	4.5	8.0	5.0	500

PART NO	A	B	C	D	E	PACKAGE
TORC-58	6.1	3.5	3.0	1.5	1.1	2000
TORC-59	10.0	5.0	3.95	4.0	0.5	2000
TORC-60	4.0	2.7	2.1	0.8	0.8	2000
TORC-61	6.0	3.55	3.0	4.6	2.0	2000
TORC-64	6.2	3.6	2.95	2.9	1.9	2000
TORC-65	9.0	6.0	4.5	8.0	2.0	2000
TORC-66	7.0	4.4	3.2	7.5	0.5	2000
TORC-67	5.0	4.1	2.2	1.2	1.2	2000
TORC-68	21.0	17.4	16.2	2.8	0.8	2000
TORC-69	6.0	3.6	2.95	2.4	1.2	2000
TORC-70	6.0	3.6	2.95	4.8	1.2	2000
TORC-135	8.0	3.8	3.1	1.2	1.2	2000
TORC-71	6.2	3.6	2.95	12.0	1.9	2000

# 晶体管垫片 TRNASTOR WASHER 垫圈 绝缘粒 塑料垫片 华司 电晶体垫片



- MATERIAL : PBT/PC V-2/PC V-0/ 用途: 晶体管垫片, 也称电晶体垫片,  
 ◆ POM/N46 V-0/N6 V-2/N66 V-2/ 锁于晶体管上, 避免晶体外壳与  
 N66 V-0 散热片间造成短路。  
 ◆ FLAME CLASS : 94V-0/94V-2  
 ◆ COLOR : NATURAL/BLACK  
 ◆ UNIT: mm

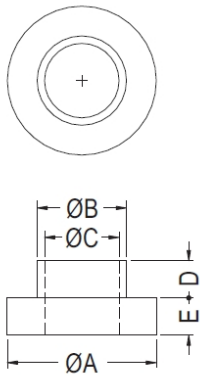

PART NO	A	B	C	D	E	PACKAGE
TORC-140	8.7	5.4	4.6	6.5	2.0	2000
TORC-141	8.1	3.6	2.95	2.5	1.3	2000
TORC-142	4.8	3.0	2.6	3.5	1.2	2000
TORC-143	3.0	2.0	0.9	3.5	0.5	2000
TORC-144	6.2	3.55	2.95	8.0	2.2	2000
TORC-145	11.0	6.2	5.0	4.9	1.0	2000
TORC-146	11.1	6.35	5.1	6.35	7.9	2000
TORC-147	8.0	4.25	3.2	3.0	2.0	2000
TORC-148	6.5	5.4	5.1	2.5	1.0	2000
TORC-149	9.0	6.0	4.0	6.3	2.0	2000
TORC-150	4.6	3.0	2.3	1.6	1.2	2000
TORC-151	3.0	1.8	0.9	1.0	0.5	2000
TORC-152	6.0	3.1	2.6	1.5	1.0	2000
TORC-153	20.0	11.9	6.5	2.5	3.0	2000
TORC-154	11.0	8.0	5.5	8.0	3.0	2000
TORC-155	4.2	3.0	2.6	1.0	2.25	2000
TORC-156	23.7	13.0	10.0	13.0	2.0	2000
TORC-157	23.7	13.0	10.0	23.0	2.0	2000
TORC-158	20.0	11.0	8.1	8.0	2.0	2000
TORC-159	20.0	11.0	8.1	13.0	2.0	2000
TORC-160	8.0	4.4	3.2	0.9	2.0	2000
TORC-161	13.0	9.8	4.5	10.3	2.0	2000
TORC-182	13.0	7.9	6.6	1.6	1.7	2000
TORC-183	6.4	3.55	3.0	1.5	0.9	2000
TORC-184	10.5	9.5	8.0	0.7	1.0	2000
TORC-185	11.5	7.5	6.7	2.0	1.0	2000
TORC-186	15.0	7.9	4.2	2.0	1.5	2000
TORC-187	8.5	5.75	5.2	3.0	1.2	2000
TORC-188	8.7	5.2	4.4	0.8	1.6	2000
TORC-189	16.0	8.0	5.0	1.55	0.85	2000
TORC-191	22.0	16.0	10.5	4.5	1.5	2000
TORC-192	8.7	5.2	4.4	4.7	1.6	2000

PART NO	A	B	C	D	E	PACKAGE
TORC-105	24.0	11.2	9.0	3.0	1.1	2000
TORC-106	12.0	7.6	6.1	16.5	2.0	2000
TORC-107	6.2	3.5	3.0	2.0	1.9	2000
TORC-108	13.0	7.9	6.6	6.4	1.7	2000
TORC-109	10.36	6.1	5.59	4.75	1.57	2000
TORC-110	6.0	4.2	3.2	3.5	0.6	2000
TORC-111	10.0	6.3	4.2	10.5	7.0	2000
TORC-112	10.0	6.3	4.2	15.5	7.0	2000
TORC-113	11.0	8.2	5.5	15.0	2.0	2000
TORC-136	14.0	8.6	7.95	5.0	2.0	2000
TORC-137	15.75	10.0	6.5	19.0	3.0	2000
TORC-138	15.75	10.0	6.5	39.0	3.0	2000
TORC-139	5.0	3.6	2.95	4.8	1.2	2000

# 晶体管垫片 TRNASTOR WASHER 垫圈 绝缘粒 塑料垫片 华司 电晶体垫片



- MATERIAL : PBT/PC V-2/PC V-0/ 用途: 晶体管垫片, 也称电晶体垫片,  
 ◆ POM/N46 V-0/N6 V-2/N66 V-2/ 锁于晶体管上, 避免晶体外壳与  
 N66 V-0 散热片间造成短路。  
 ◆ FLAME CLASS : 94V-0/94V-2  
 ◆ COLOR : NATURAL/BLACK  
 ◆ UNIT: mm

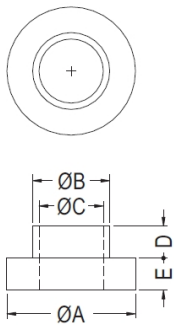

PART NO	A	B	C	D	E	PACKAGE
TORC-206	10.0	7.0	5.0	2.0	1.0	2000
TORC-207	26.0	16.0	14.0	5.0	5.0	2000
TORC-208	12.0	8.0	5.0	7.0	2.0	2000
TORC-209	12.0	6.0	4.0	15.0	2.0	2000
TORC-217	12.0	8.0	6.0	3.0	1.0	2000
TORC-218	14.0	8.0	6.0	3.0	3.0	2000
TORC-219	16.0	12.0	10.0	3.0	1.0	2000
TORC-220	16.0	8.0	6.0	6.0	5.0	2000
TORC-221	12.0	7.0	5.0	6.0	2.0	2000
TORC-222	5.5	3.5	3.0	2.6	0.6	2000
TORC-223	19.0	9.4	8.2	1.7	0.8	2000
TORC-233	7.4	4.3	3.6	1.6	1.2	2000
TORC-234	6.0	3.7	2.9	6.4	1.2	2000
TORC-235	7.9	4.5	3.65	6.0	1.2	2000
TORC-236	20.0	11.0	8.0	4.0	2.0	2000
TORC-239	12.0	7.9	4.2	6.0	3.2	2000
TORC-244	20.7	7.6	6.0	7.7	0.8	2000
TORC-245	6.35	4.75	3.66	0.81	1.57	2000
TORC-246	7.92	4.75	3.66	0.81	1.57	2000
TORC-247	6.1	3.5	2.9	1.6	2.4	2000
TORC-248	11.5	7.5	5.5	8.0	1.0	2000
TORC-249	8.7	5.2	4.4	3.2	1.6	2000
TORC-250	10.0	3.9	3.1	1.7	1.3	2000
TORC-251	6.3	3.5	3.0	7.3	1.6	2000
TORC-254	6.0	3.7	2.9	9.5	1.2	2000
TORC-256	6.4	4.7	3.0	1.3	0.8	2000
TORC-257	8.7	5.2	4.4	1.6	1.6	2000
TORC-258	9.5	7.9	6.4	1.5	0.8	2000
TORC-259	12.5	7.92	6.6	1.98	0.81	2000
TORC-275	10.0	3.9	2.6	1.7	1.3	2000
TORC-276	18.0	10.9	10.2	2.5	1.5	2000
TORC-277	6.0	3.3	2.1	1.5	1.0	2000

PART NO	A	B	C	D	E	PACKAGE
TORC-193	12.0	9.0	6.0	6.0	2.0	2000
TORC-194	20.0	12.0	8.0	10.0	3.0	2000
TORC-195	20.0	12.0	8.0	7.0	2.0	2000
TORC-196	10.0	7.0	5.0	10.0	1.0	2000
TORC-197	20.0	10.0	8.0	3.0	3.0	2000
TORC-198	20.0	12.0	10.0	2.0	3.0	2000
TORC-199	25.0	12.0	10.0	5.0	1.0	2000
TORC-200	18.0	16.0	12.0	9.0	1.0	2000
TORC-201	15.0	7.9	6.2	2.0	2.0	2000
TORC-202	15.0	9.9	8.2	2.0	1.5	2000
TORC-203	20.0	10.0	8.0	12.0	3.0	2000
TORC-204	15.0	8.9	6.2	3.0	1.5	2000
TORC-205	16.0	12.0	10.0	4.0	2.0	2000
TORC-273	10.15	6.6	5.1	6.35	3.2	2000
TORC-274	15.0	8.9	4.2	2.0	1.5	2000



# 晶体管垫片 TRNASTOR WASHER 垫圈 绝缘粒 塑料垫片 华司 电晶体垫片



- MATERIAL : PBT/PC V-2/PC V-0/ 用途: 晶体管垫片, 也称电晶体垫片,  
 ◆ POM/N46 V-0/N6 V-2/N66 V-2/ 锁于晶体管上, 避免晶体外壳与  
 N66 V-0 散热片间造成短路。  
 ◆ FLAME CLASS : 94V-0/94V-2  
 ◆ COLOR : NATURAL/BLACK  
 ◆ UNIT: mm

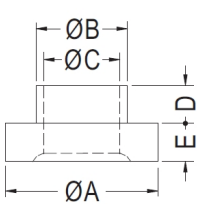
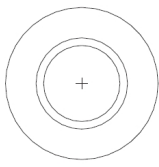

TORC-17

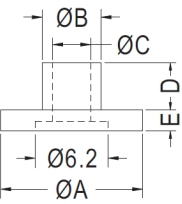
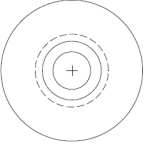

TORC-62

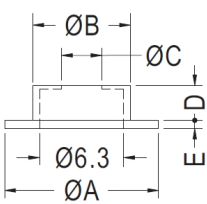
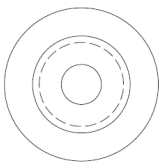

TORC-81

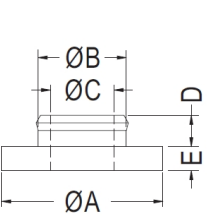
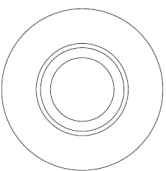

TORC-115

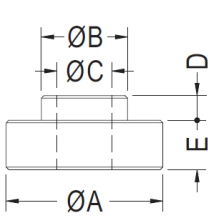
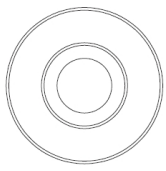

TORC-264  
TORC-265  
TORC-266

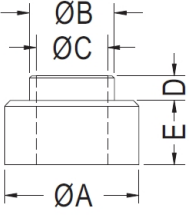
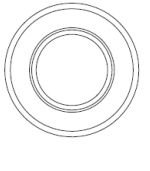

TORC-269

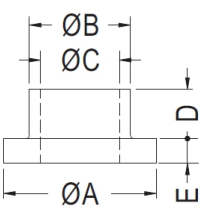
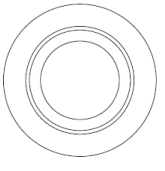

TORC-118  
TORC-166

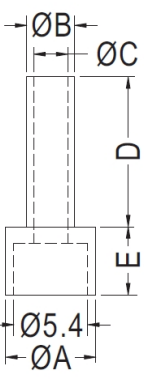

TORC-114

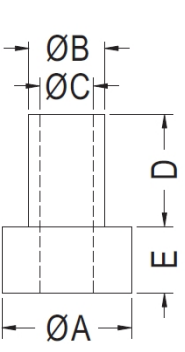
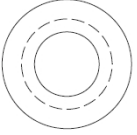

TORC-168  
TORC-169

PART NO	A	B	C	D	E	PACKAGE
TORC-17	6.2	3.55	3.0	1.4	1.2	2000
TORC-62	12.0	5.0	3.2	4.0	1.8	2000
TORC-81	11.5	7.3	3.1	2.6	0.6	2000
TORC-115	17.0	9.3	6.7	3.3	2.5	2000
TORC-264	12.0	6.6	4.2	1.9	3.8	2000
TORC-265	7.6	3.9	3.1	4.0	2.0	2000
TORC-266	14.0	7.6	5.2	2.0	3.0	2000
TORC-118	6.2	4.1	3.2	2.0	1.0	2000
TORC-166	6.2	4.3	3.1	2.0	1.0	2000
TORC-269	6.0	3.8	3.2	1.1	2.9	2000
TORC-114	6.6	3.5	2.5	11.0	5.0	2000
TORC-168	6.0	3.5	2.5	5.2	3.1	2000
TORC-169	6.0	3.5	2.5	8.6	3.1	2000

晶体管垫片

# 晶体管垫片 TRNASTOR WASHER 垫圈 绝缘粒 塑料垫片 华司 电晶体垫片



- MATERIAL : PBT/PC V-2/PC V-0/ 用途: 晶体管垫片, 也称电晶体垫片,  
 ◆ POM/N46 V-0/N6 V-2/N66 V-2/ 锁于晶体管上, 避免晶体外壳与  
 N66 V-0 散热片间造成短路。  
 ◆ FLAME CLASS : 94V-0/94V-2  
 ◆ COLOR : NATURAL/BLACK  
 ◆ UNIT: mm

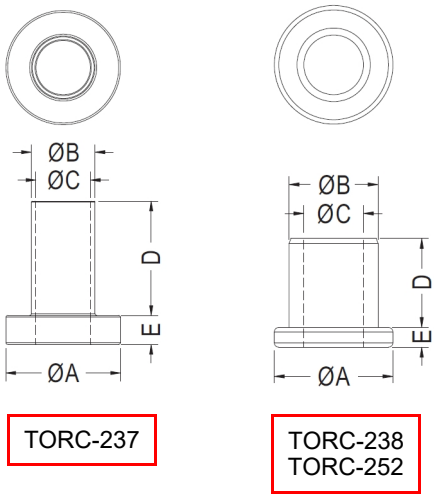
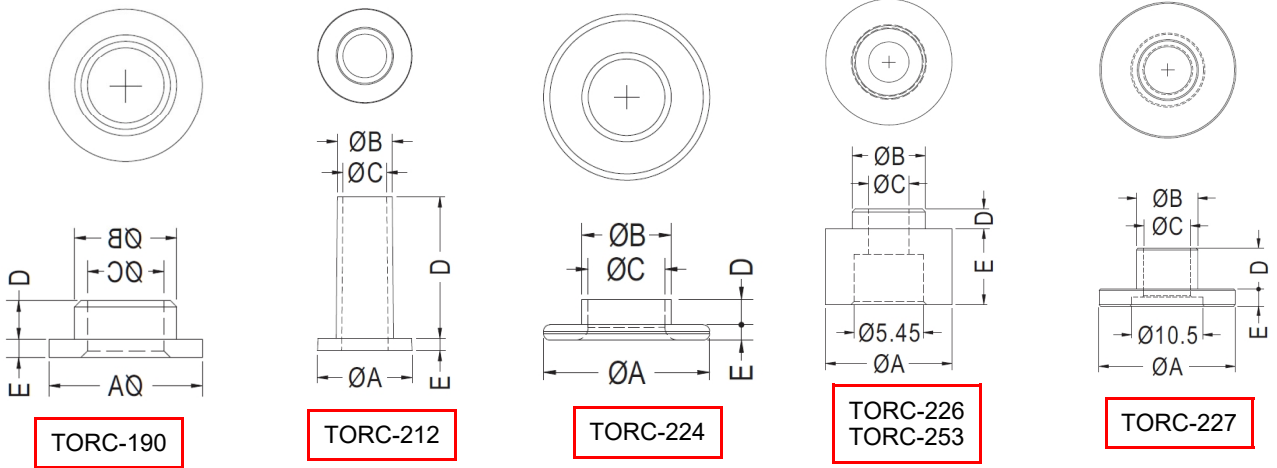
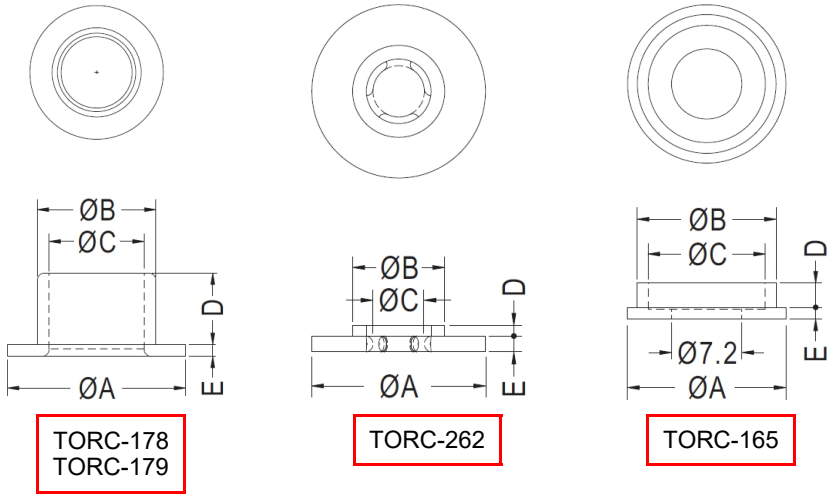

PART NO	A	B	C	D	E	PACKAGE
TORC-178	15.0	10.0	8.0	6.0	1.0	2000
TORC-179	9.0	5.0	4.2	3.0	1.0	2000
TORC-262	13.0	6.0	3.85	0.8	1.2	1000
TORC-165	16.2	14.2	12.0	2.49	1.19	2000
TORC-190	2.4	1.6	1.2	0.6	0.3	2000
TORC-212	8.0	4.65	3.7	12.0	1.0	2000
TORC-224	13.0	7.0	6.0	2.0	1.2	2000
TORC-226	10.0	5.8	3.2	1.6	6.0	2000
TORC-253	8.7	5.2	4.4	6.4	1.6	2000
TORC-227	20.0	9.0	6.9	6.0	2.5	2000
TORC-237	6.3	3.5	3.0	6.3	1.6	2000
TORC-238	12.0	9.0	6.0	9.0	2.0	2000
TORC-252	12.0	9.0	6.0	8.0	2.0	1000

晶体管垫片

# 晶体管垫片 TRNASTOR WASHER 垫圈 绝缘粒 塑料垫片 华司 电晶体垫片



- MATERIAL : PBT/PC V-2/PC V-0/ 用途: 晶体管垫片, 也称电晶体垫片,  
 ◆ POM/N46 V-0/N6 V-2/N66 V-2/ 锁于晶体管上, 避免晶体外壳与  
 N66 V-0 散热片间造成短路。  
 ◆ FLAME CLASS : 94V-0/94V-2  
 ◆ COLOR : NATURAL/BLACK  
 ◆ UNIT: mm

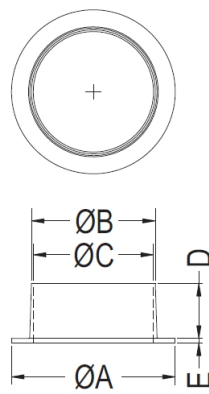

TORC-225

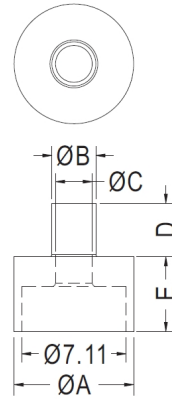

TORC-255

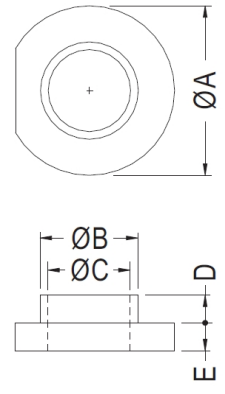

TORC-28

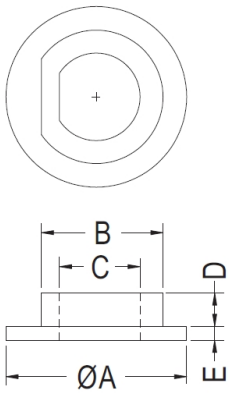

TORC-63  
 TORC-211  
 TORC-243  
 TORC-260

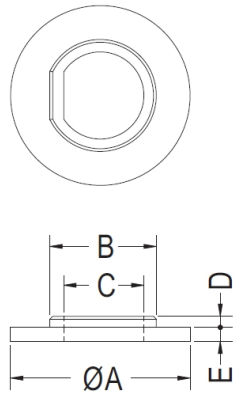

TORC-240

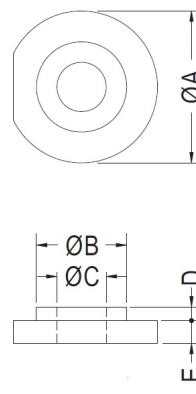

TORC-164

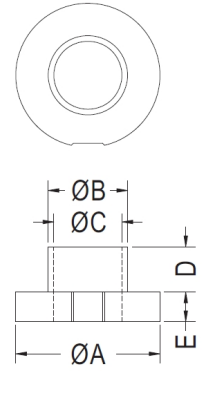

TORC-242

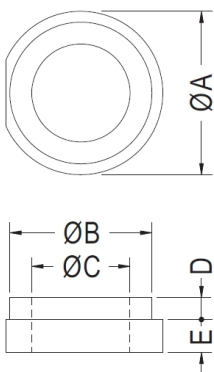

TORC-162

PART NO	A	B	C	D	E	PACKAGE
TORC-225	27.5	20.8	20.2	9.2	0.8	1000
TORC-255	8.13	3.0	2.5	3.63	5.08	2000
TORC-28	6.22	3.56	3.02	1.02	1.02	2000
TORC-63	13.0	8.75	5.8	2.4	1.0	2000
TORC-162	9.53	8.26	5.72	1.27	1.91	2000
TORC-164	20.3	11.9	6.5	1.8	3.0	2000
TORC-211	13.0	8.75	5.8	1.9	1.0	2000
TORC-240	13.0	7.7	5.8	0.8	1.0	2000
TORC-242	6.4	3.55	3.0	2.0	1.3	2000
TORC-243	10.4	8.4	6.4	0.5	1.0	2000
TORC-260	16.0	10.16	8.86	1.0	0.85	2000

晶体管垫片



**晶体管垫片 TRNASISTOR WASHER 垫圈 绝缘粒 塑料垫片 华司 电晶体垫片**



- ◆ MATERIAL : NYLON 46 (UL)
- ◆ FLAME CLASS : 94V-0
- ◆ COLOR : NATURAL
- ◆ UNIT: mm

用途：晶体管垫片，也称电晶体垫片，锁于晶体管上，避免晶体外壳与散热片间造成短路。

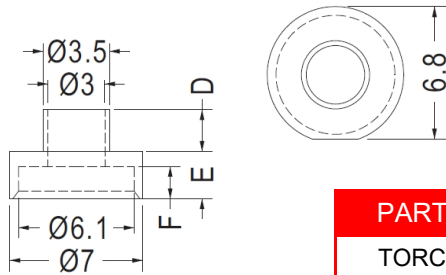

PART NO	PACKAGE
TORC-116	2000



- ◆ MATERIAL : PPS (UL)
- ◆ FLAME CLASS : 94V-0
- ◆ COLOR : NATURAL/BLACK
- ◆ UNIT: mm

用途：晶体管垫片，也称电晶体垫片，锁于晶体管上，避免晶体外壳与散热片间造成短路。

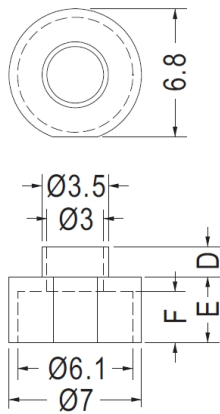

PART NO	D	E	F	PACKAGE
TORC-120	2.4	6.5	4.6	2000
TORC-121	1.6	3.5	2.7	2000
TORC-122	2.2	3.8	3.0	2000
TORC-123	1.6	3.5	2.1	2000
TORC-124	2.4	3.9	3.0	2000
TORC-125	1.6	5.0	4.2	2000
TORC-126	2.4	4.9	3.0	2000
TORC-127	1.6	3.8	3.0	2000
TORC-128	1.6	2.8	2.0	2000
TORC-163	3.2	5.0	4.2	2000
TORC-241	2.8	4.2	3.4	2000

晶体管垫片

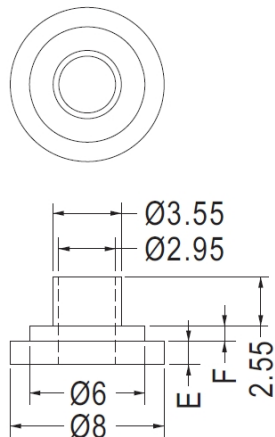

PART NO	E	F	PACKAGE
TORC-117	1.2	0.8	2000
TORC-228	1.0	1.6	2000

晶体管垫片 TRNASTOR WASHER 垫圈 绝缘粒 塑料垫片 华司 电晶体垫片

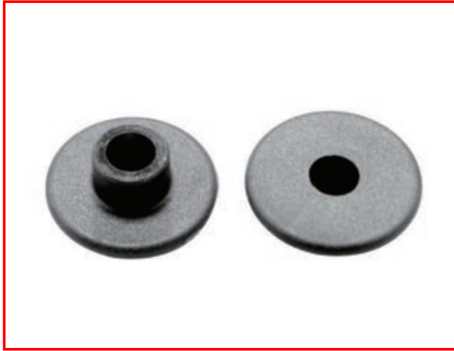

- ◆ MATERIAL : NYLON 46 (UL)
- ◆ FLAME CLASS : 94V-0/94V-2
- ◆ COLOR : NATURAL/BLACK
- ◆ UNIT: mm

用途：晶体管垫片，也称电晶体垫片，用于零件之绝缘使用。

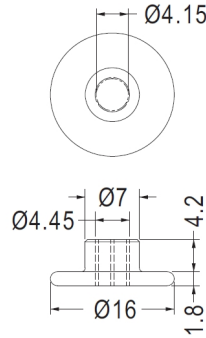

PART NO	PACKAGE
TORC-119	1000



- ◆ MATERIAL : PC
- ◆ COLOR : BLACK
- ◆ UNIT: mm

用途：晶体管垫片，也称电晶体垫片，用于零件之绝缘使用。

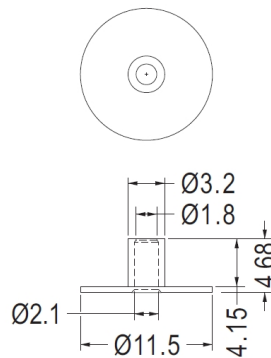

PART NO	PACKAGE
TORC-177	1000

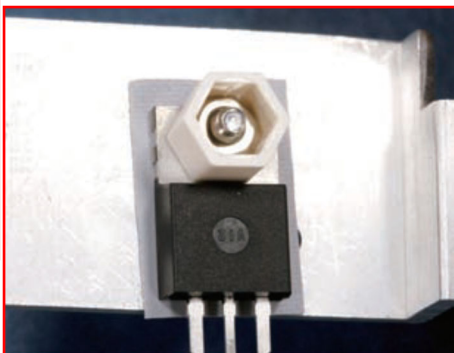

- ◆ MATERIAL : NYLON 46 (UL)
- ◆ FLAME CLASS : 94V-0/94V-2
- ◆ COLOR : NATURAL/BLACK
- ◆ UNIT: mm

用途：晶体管垫片，也称电晶体垫片，锁于晶体管上，避免晶体外壳与散热片间造成短路。

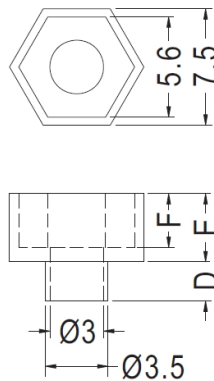
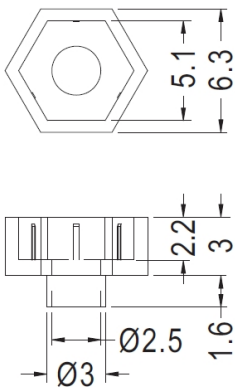
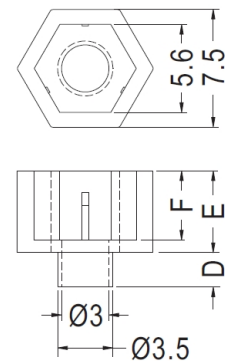

PART NO	D	E	F	PACKAGE
TORC-129	1.6	6.4	5.0	2000
TORC-130	1.6	5.0	4.2	2000
TORC-131	2.2	5.2	4.4	2000
TORC-132	1.6	4.0	3.2	2000
TORC-133	2.4	6.3	4.4	2000
TORC-134	1.6	5.2	4.4	2000
TORC-210	1.6	3.4	2.6	2000

PART NO	PACKAGE
TORC-230	1000

PART NO	PACKAGE
TORC-229	1000

# 晶体管垫片 TRNASTOR WASHER 垫圈 绝缘粒 塑料垫片 华司 电晶体垫片



- ◆ MATERIAL : PPS (UL)
- ◆ FLAME CLASS : 94V-0
- ◆ COLOR : NATURAL (BROWN)
- ◆ UNIT: mm

用途：晶体管垫片，也称电晶体垫片，锁于晶体管上，避免晶体外壳与散热片间造成短路。

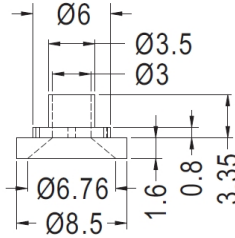
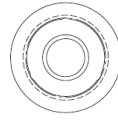

PART NO	PACKAGE
TORC-167	2000



- ◆ MATERIAL : NYLON 6T (UL)
- ◆ FLAME CLASS : 94V-0
- ◆ COLOR : NATURAL
- ◆ UNIT: mm

用途：晶体管垫片，也称电晶体垫片，锁于晶体管上，避免晶体外壳与散热片间造成短路。

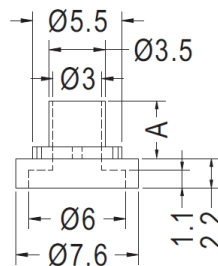
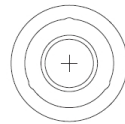

PART NO	A	PACKAGE
TORC-180	3.6	2000
TORC-216	4.2	2000



- ◆ MATERIAL : NYLON 46 (UL)
- ◆ FLAME CLASS : 94V-0
- ◆ COLOR : NATURAL
- ◆ UNIT: mm

用途：晶体管垫片，也称电晶体垫片，锁于晶体管上，避免晶体外壳与散热片间造成短路。

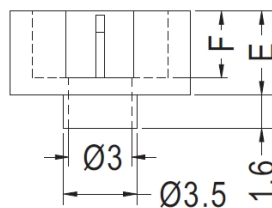
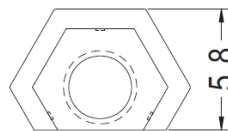

PART NO	E	F	PACKAGE
TORC-170	4.0	3.2	2000
TORC-171	5.0	4.2	2000



**晶体管垫片 TRNASTOR WASHER 垫圈 绝缘粒 塑料垫片 华司 电晶体垫片**

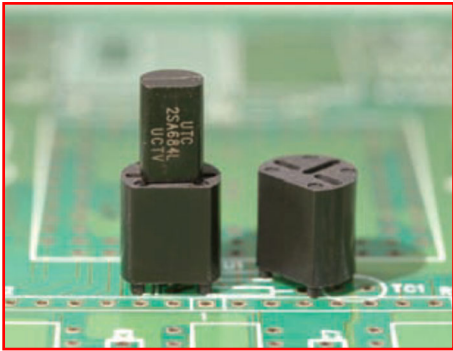

- ◆ MATERIAL : NYLON 66 (UL)
- ◆ FLAME CLASS : 94V-0/94V-2
- ◆ COLOR : NATURAL/BLACK
- ◆ UNIT: mm

用途：晶体管垫片，也称电晶体垫片，保护TO-92功率晶体立于PC板上，高度一致，不断脚。

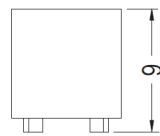
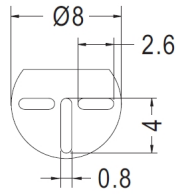

PART NO	PACKAGE
TO-92-9	1000

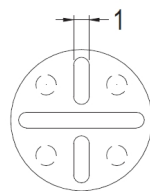
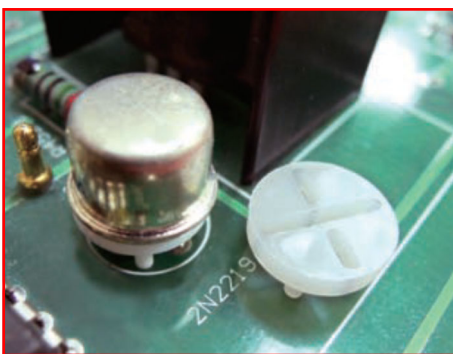

用途：晶体管垫片，也称电晶体垫片，用于桥式整流器或机晶体管之垫高。

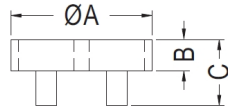

PART NO	A	B	C	PACKAGE
TORC-174	9.0	2.0	4.2	2000
TORC-175	14.0	1.0	2.1	2000

晶体管垫片



- ◆ MATERIAL : PET
- ◆ COLOR : GRAY
- ◆ UNIT: mm

用途：晶体管垫片，也称电晶体垫片，锁于晶体管上，避免晶体外壳与散热片间造成短路。

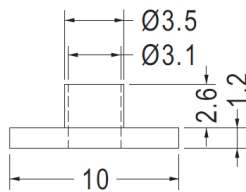

PART NO	PACKAGE
TORC-181	1000

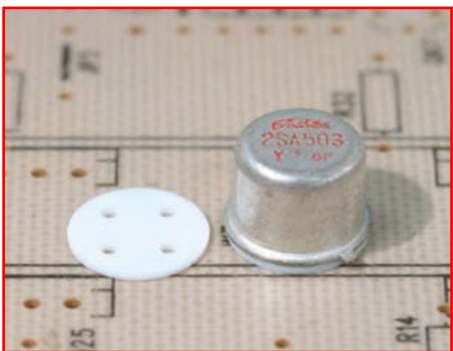

- ◆ MATERIAL : NYLON 66 (UL)
- ◆ FLAME CLASS : 94V-0/94V-2
- ◆ COLOR : NATURAL/BLACK/WHITE
- ◆ UNIT: mm

用途：晶体管垫片，也称电晶体垫片，保护TO-05晶体立于PC板上，且高度一致，不断脚。

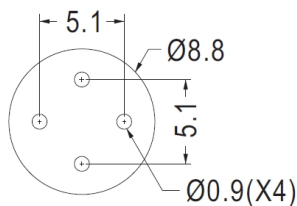

PART NO	PACKAGE
TO-05-1	1000

晶体管垫片 TRNASISTOR WASHER 垫圈 绝缘粒 塑料垫片 华司 电晶体垫片



- ◆ MATERIAL : PPS (UL)
- ◆ FLAME CLASS : 94V-0
- ◆ COLOR : BLACK
- ◆ UNIT: mm

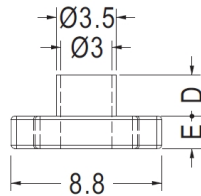
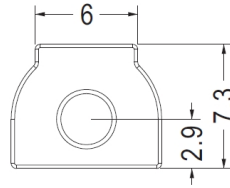

用途：晶体管垫片，也称电晶体垫片，锁于晶体管上，避免晶体外壳与散热片间造成短路。

PART NO	E	F	PACKAGE
TORC-214	2.4	1.9	1000
TORC-215	1.6	1.3	1000



- ◆ MATERIAL : POM
- ◆ COLOR : BLACK
- ◆ UNIT: mm

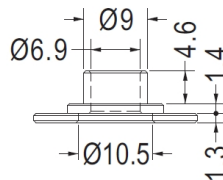
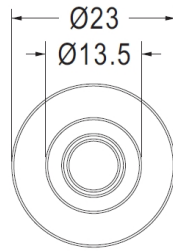

用途：晶体管垫片，也称电晶体垫片，锁于晶体管上，避免晶体外壳与散热片间造成短路。

PART NO	PACKAGE
TORC-231	2000



- ◆ MATERIAL : NYLON 66 (UL)
- ◆ FLAME CLASS : 94V-0/94V-2
- ◆ COLOR : NATURAL/BLACK
- ◆ UNIT: mm

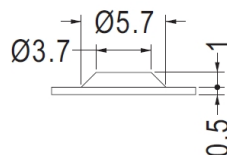
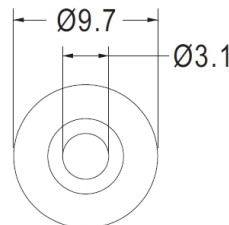

用途：晶体管垫片，也称电晶体垫片，做为零件之垫片。

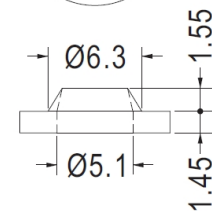
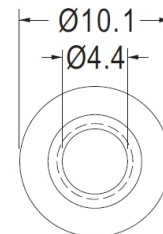

PART NO	PACKAGE
TORC-232	1000

PART NO	PACKAGE
TORC-263	2000

晶体管垫片 TRANSISTOR WASHER 垫圈 绝缘粒 塑料垫片 华司 电晶体垫片

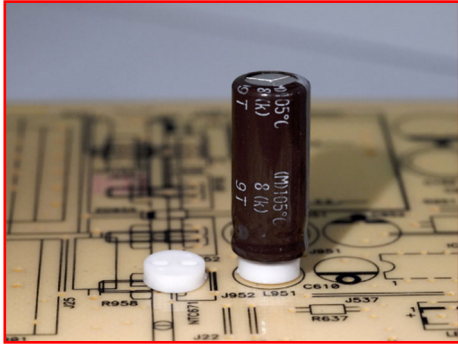

- ◆ MATERIAL : NYLON 66(UL)
- ◆ FLAME CLASS : 94V-2/94V-0
- ◆ COLOR : BLACK/NATURAL
- ◆ UNIT: mm

用途：晶体管垫片，也称电晶体垫片，保护晶体立于PC板上，高度一致，不断脚。

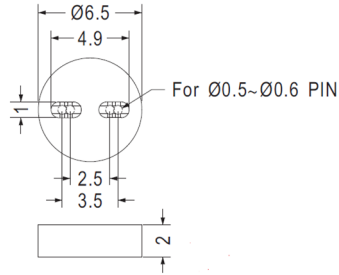

PART NO	PACKAGE
TORC-271	2000

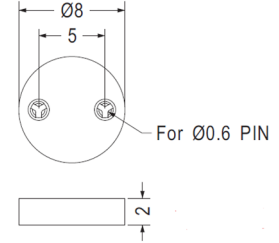

PART NO	PACKAGE
TORC-272	2000



# 晶体管座 TRNASTOR HOUSING 电晶体座

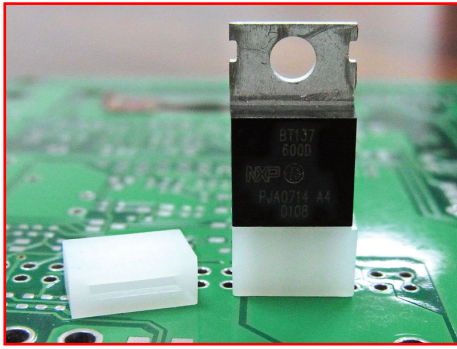

- ◆ MATERIAL : NYLON 66 (UL)
- ◆ FLAME CLASS : 94V-0/94V-2
- ◆ COLOR : NATURAL/BLACK
- ◆ UNIT: mm

用途：晶体管座，也称电晶体座，用于晶体管或零件之垫高与保护。

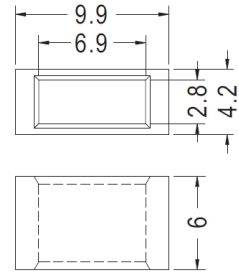
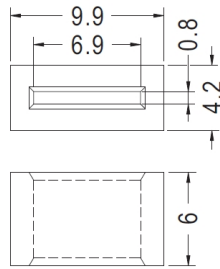

PART NO	PACKAGE
DTZ-4	1000

PART NO	PACKAGE
DTZ-58	1000

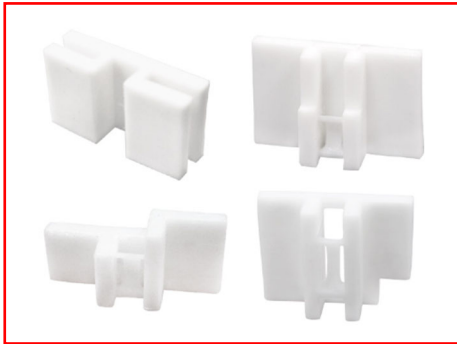

- ◆ MATERIAL : PTB (UL)
- ◆ FLAME CLASS : 94V-0
- ◆ COLOR : NATURAL
- ◆ UNIT: mm

用途：晶体管座，也称电晶体座，保护晶体立于PC板上，使接脚不弯曲、折断、短路、且高度一致。

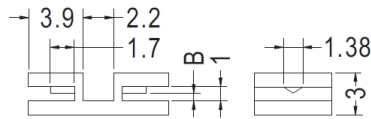
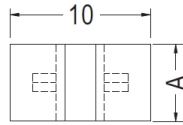

PART NO	E	F	PACKAGE
DTZ-10	5.5	0.5~0.6	1000
DTZ-11	5.5	0.4	1000
DTZ-12	7.5	0.5~0.6	1000

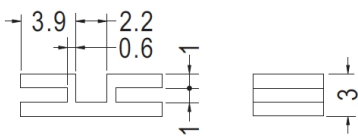
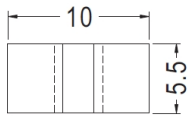

PART NO	PACKAGE
DTZ-6	1000

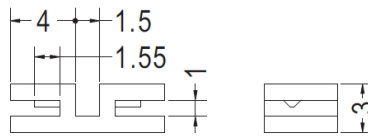
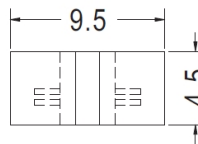

PART NO	PACKAGE
DTZ-8	1000

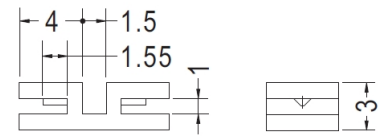
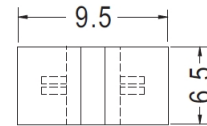

PART NO	PACKAGE
DTZ-9	1000

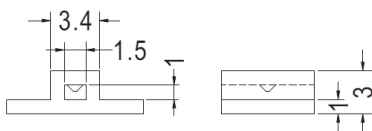
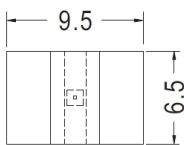

PART NO	PACKAGE
DTZ-5	1000

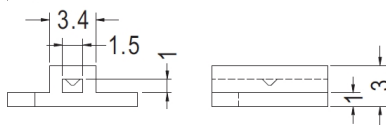
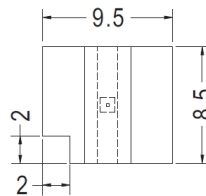

PART NO	PACKAGE
DTZ-7	1000

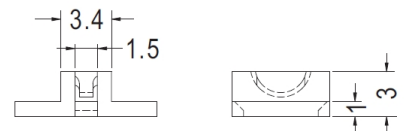
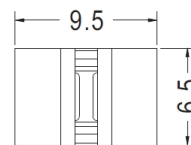

PART NO	PACKAGE
DTZ-14	1000

# 晶体管座 TRNASTOR HOUSING 电晶体座

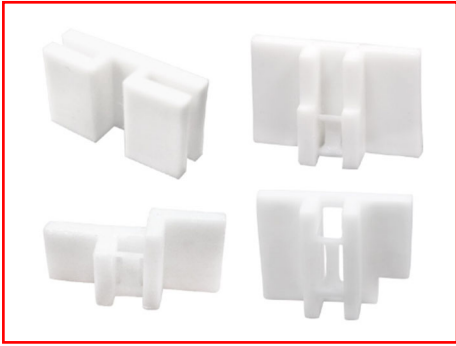

- ◆ MATERIAL : PTB (UL)
- ◆ FLAME CLASS : 94V-0
- ◆ COLOR : NATURAL
- ◆ UNIT: mm

用途：晶体管座，也称电晶体座，保护晶体立于PC板上，使接脚不弯曲、折断、短路、且高度一致。

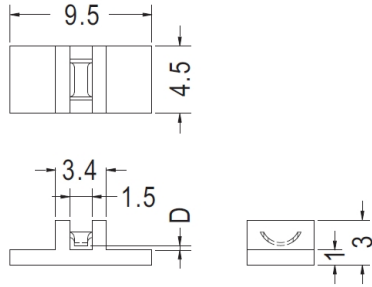

PART NO	A	PACKAGE
DTZ-17	0.3	1000
DTZ-18	0.5	1000

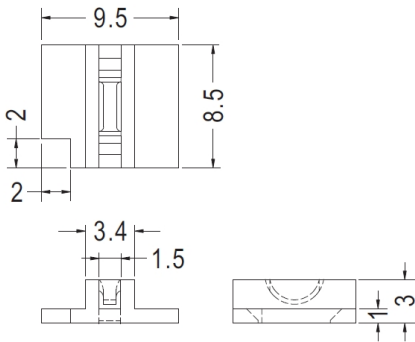

PART NO	PACKAGE
DTZ-15	1000

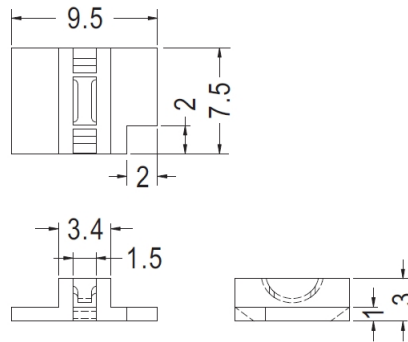

PART NO	PACKAGE
DTZ-21	1000

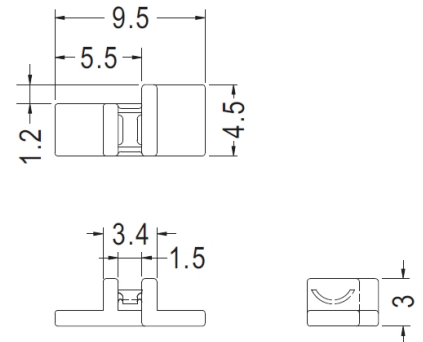

PART NO	PACKAGE
DTZ-55	1000

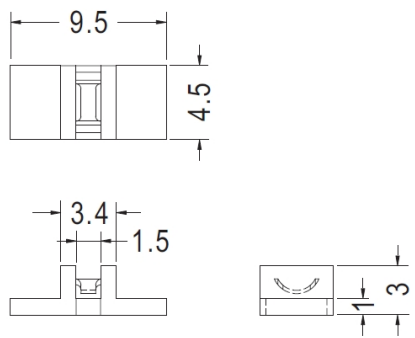

PART NO	PACKAGE
DTZ-16	1000

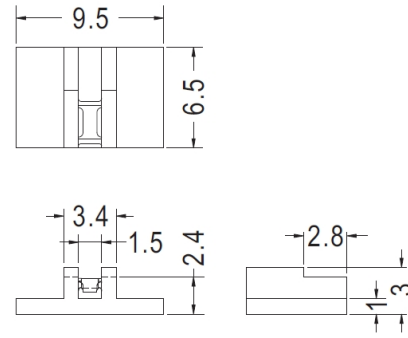

PART NO	PACKAGE
DTZ-75	1000

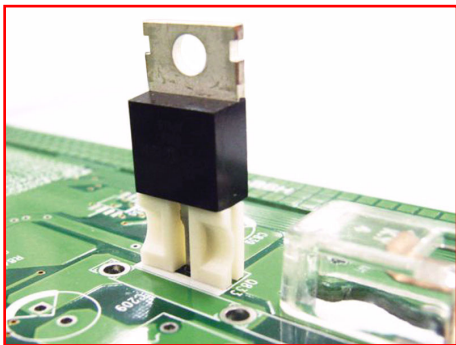

- ◆ MATERIAL : NYLON 66 (UL)
- ◆ FLAME CLASS : 94V-0
- ◆ COLOR : NATURAL/BLACK
- ◆ UNIT: mm

用途：晶体管座，也称电晶体座，保护晶体立于PC板上，使接脚不弯曲、折断、短路、且高度一致。

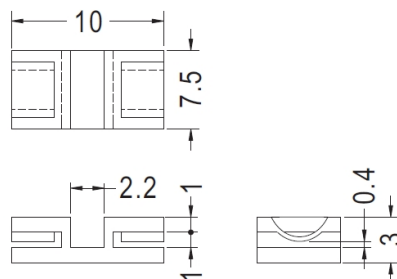

PART NO	PACKAGE
DTZ-13	1000

# 晶体管座 TRNASTOR HOUSING 电晶体座

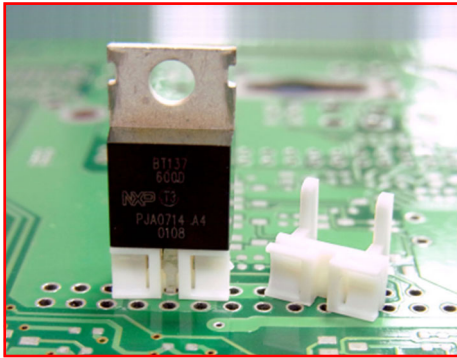

- ◆ MATERIAL : NYLON 66 (UL)
- ◆ FLAME CLASS : 94V-0/94V-2
- ◆ COLOR : NATURAL/BLACK
- ◆ UNIT: mm

用途：晶体管座，也称电晶体座，保护晶体立于PC板上，使接脚不弯曲、折断、短路、且高度一致。

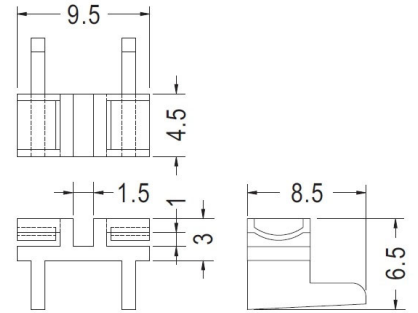
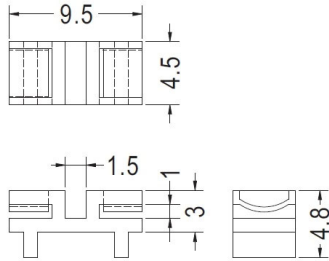

PART NO	PACKAGE
DTZ-19	1000

PART NO	PACKAGE
DTZ-20	1000

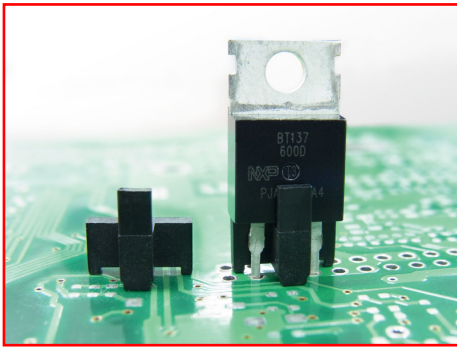

- ◆ MATERIAL : PTB (UL)
- ◆ FLAME CLASS : 94V-0
- ◆ COLOR : BLACK
- ◆ UNIT: mm

用途：晶体管座，也称电晶体座，保护晶体立于PC板上，使接脚不弯曲、折断、短路、且高度一致。

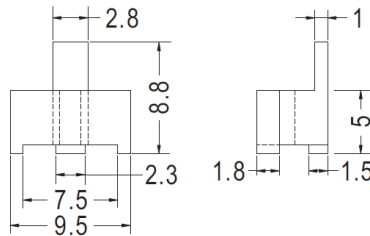
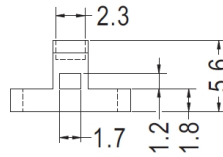

PART NO	PACKAGE
DTZ-22	1000

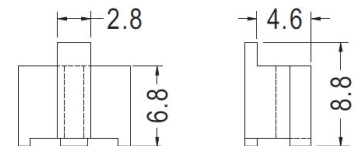
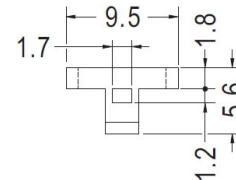
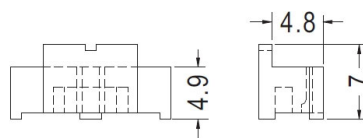
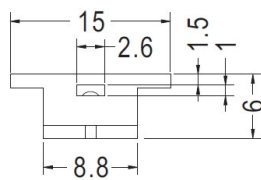
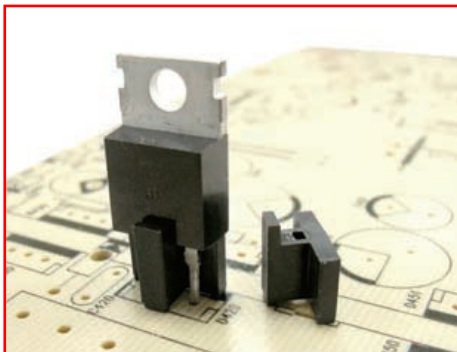

PART NO	PACKAGE
DTZ-23	1000

PART NO	PACKAGE
DTZ-24	1000

晶体管座

# 晶体管座 TRNASTOR HOUSING 电晶体座

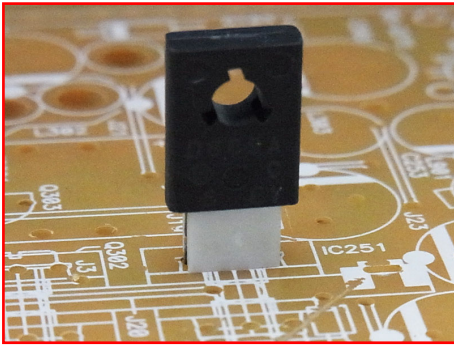

- ◆ MATERIAL : NYLON 66 (UL)
- ◆ FLAME CLASS : 94V-0/94V-2
- ◆ COLOR : NATURAL/BLACK
- ◆ UNIT: mm

用途：晶体管座，也称电晶体座，保护晶体立于PC板上，使接脚不弯曲、折断、短路、且高度一致。

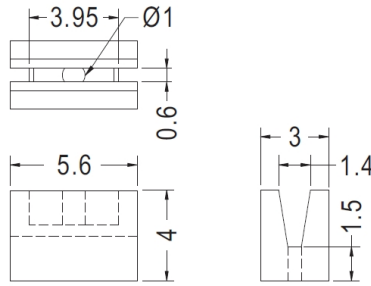

PART NO	PACKAGE
DTZ-25	1000

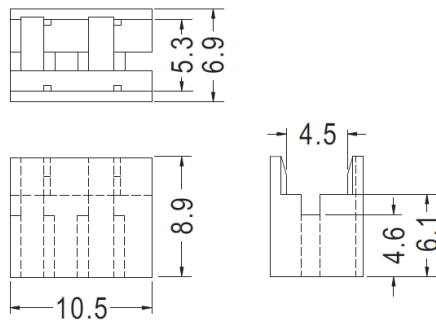
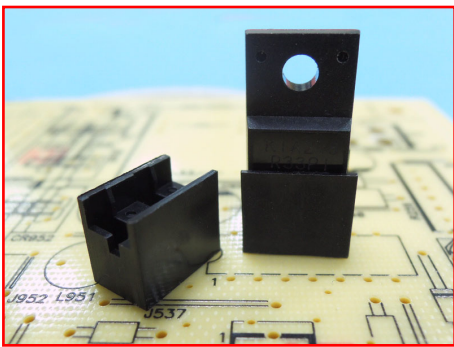

PART NO	PACKAGE
DTZ-27	1000

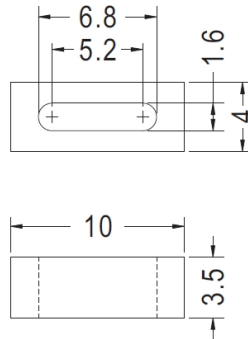
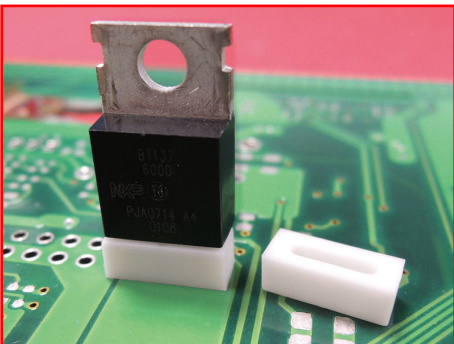

PART NO	PACKAGE
DTZ-54	1000

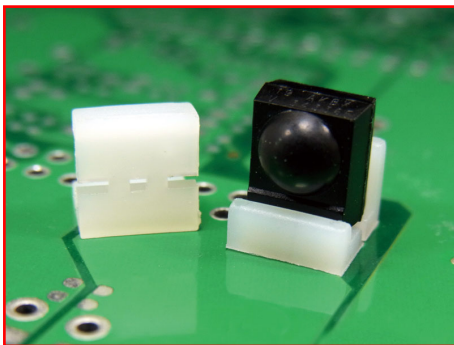

- ◆ MATERIAL : NYLON 66 (UL)
- ◆ FLAME CLASS : 94V-0/94V-2
- ◆ COLOR : NATURAL/BLACK
- ◆ UNIT: mm

用途：晶体管座，也称电晶体座，保护IR晶体立于PC板上，使接脚不弯曲、折断、短路、且高度一致。

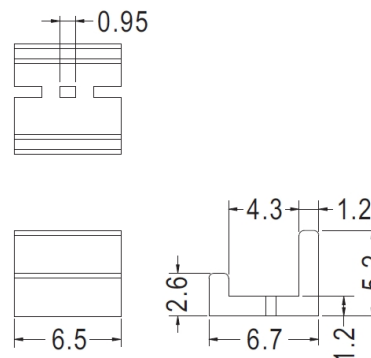

PART NO	PACKAGE
DTZ-26	1000



# 晶体管座 TRNASTOR HOUSING 电晶体座



- ◆ MATERIAL : NYLON 66 (UL)/PBT(UL) 用途: 晶体管座, 也称电晶体座,
- ◆ FLAME CLASS : 94V-0/94V-2 保护晶体立于PC板上, 使接
- ◆ COLOR : NATURAL/BLACK 脚不弯曲、折断、短路、且
- ◆ UNIT: mm 高度一致。

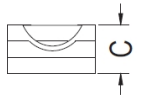
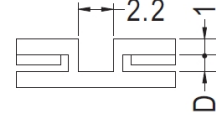
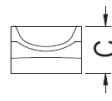
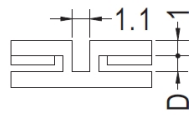
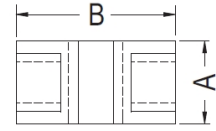
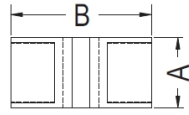

DTZ-71

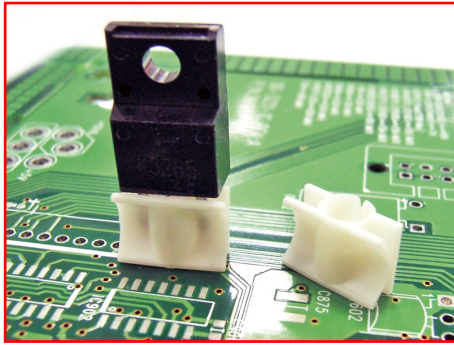
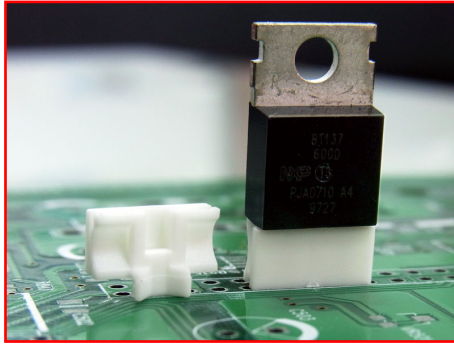

PART NO	A	B	C	D	PACKAGE
DTZ-28	4.0	10.0	3.0	1.0	1000
DTZ-29	4.5	10.0	3.0	1.0	1000
DTZ-30	5.0	10.0	3.0	1.0	1000
DTZ-31	5.5	10.0	3.0	1.0	1000
DTZ-32	6.0	10.0	3.0	1.0	1000
DTZ-33	6.5	10.0	3.0	1.0	1000
DTZ-34	7.0	10.0	3.0	1.0	1000
DTZ-35	7.5	10.0	3.0	1.0	1000
DTZ-36	8.0	10.0	3.0	1.0	1000
DTZ-37	8.5	10.0	3.0	1.0	1000
DTZ-38	9.0	10.0	3.0	1.0	1000
DTZ-39	9.5	10.0	3.0	1.0	1000
DTZ-40	10.0	10.0	3.0	1.0	1000
DTZ-49	3.5	10.0	3.0	1.0	1000
DTZ-71	4.5	9.0	3.0	1.0	1000
DTZ-78	6.5	10.0	3.3	1.3	1000

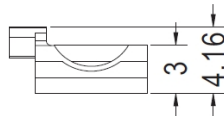
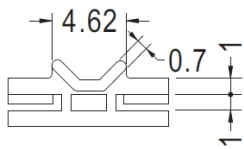
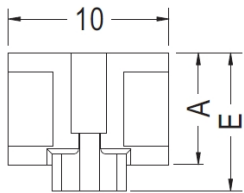

PART NO	A	B	PACKAGE
DTZ-41	5.0	6.6	1000
DTZ-42	6.7	8.3	1000
DTZ-43	7.0	8.6	1000

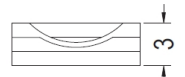
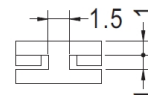
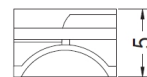
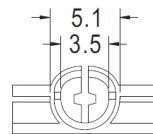
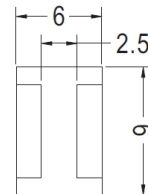
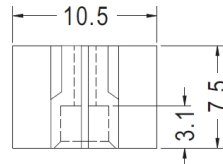

PART NO	PACKAGE
DTZ-44	1000

PART NO	PACKAGE
DTZ-57	1000

晶体管座

# 晶体管座 TRNASTOR HOUSING 电晶体座

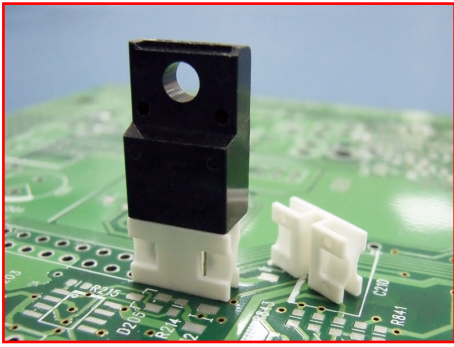

- ◆ MATERIAL : NYLON 66 (UL)/PBT(UL) 用途: 晶体管座, 也称电晶体座,
- ◆ FLAME CLASS : 94V-0/94V-2 保护晶体立于PC板上, 使接
- ◆ COLOR : NATURAL/BLACK 脚不弯曲、折断、短路、且
- ◆ UNIT: mm 高度一致。

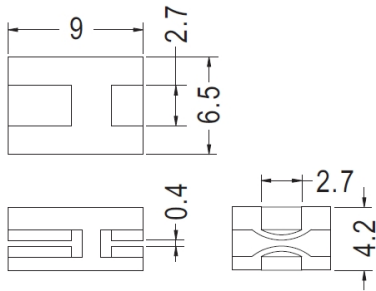

PART NO	PACKAGE
DTZ-45	1000

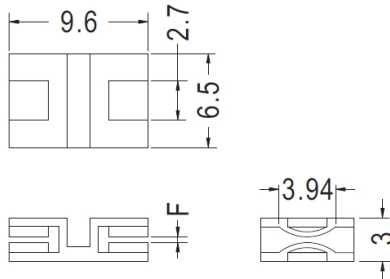

PART NO	A	PACKAGE
DTZ-46	0.4	1000
DTZ-47	0.5	1000

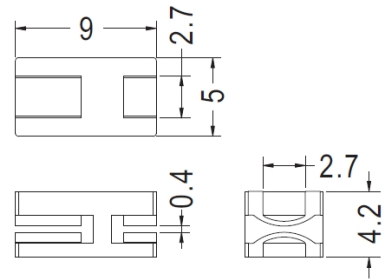

PART NO	PACKAGE
DTZ-79	1000

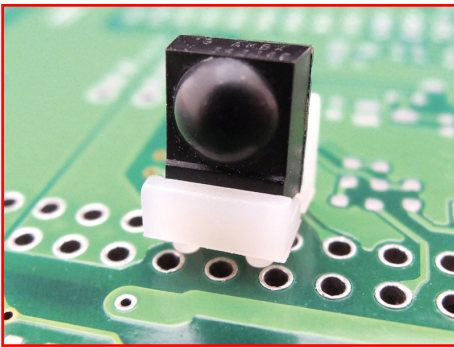

- ◆ MATERIAL : NYLON 66 (UL) 用途: 晶体管座, 也称电晶体座, 保护
- ◆ FLAME CLASS : 94V-0/94V-2 IR晶体立于PC板上, 使接脚不弯
- ◆ COLOR : NATURAL/BLACK 曲、折断、短路, 且高度一致。
- ◆ UNIT: mm

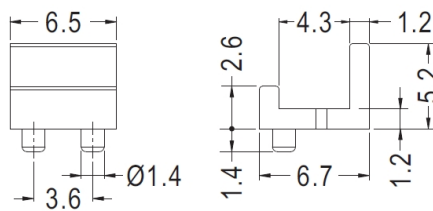
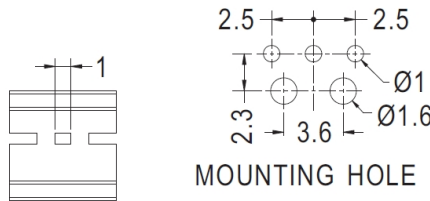

PART NO	PACKAGE
DTZ-50	1000

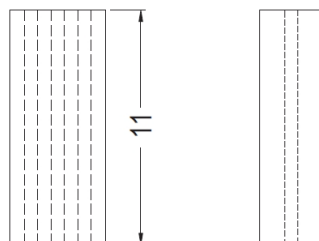
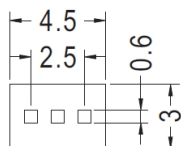
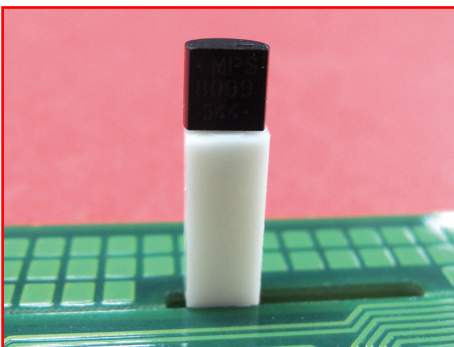

- 用途: 晶体管座, 也称电晶体座, 保护
- 晶体立于PC板上, 使接脚不弯
- 曲、折断、短路, 且高度一致。

PART NO	PACKAGE
TR3-11-1	1000

# 晶体管座 TRNASTOR HOUSING 电晶体座

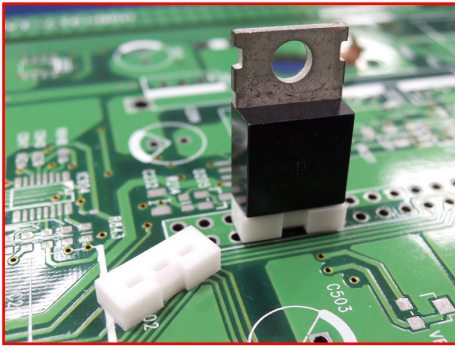

- ◆ MATERIAL : NYLON 66 (UL)
- ◆ FLAME CLASS : 94V-0/94V-2
- ◆ COLOR : NATURAL/BLACK
- ◆ UNIT: mm

用途：晶体管座，也称电晶体座，保护晶体立于PC板上，使接脚不弯曲、折断、短路、且高度一致。

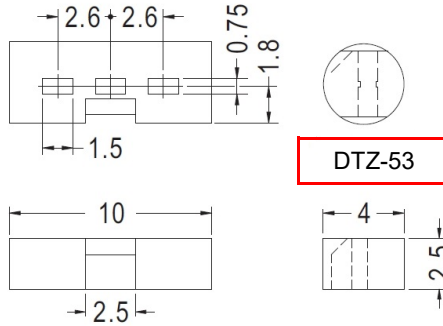

PART NO	PACKAGE
DTZ-52	1000
DTZ-53	1000

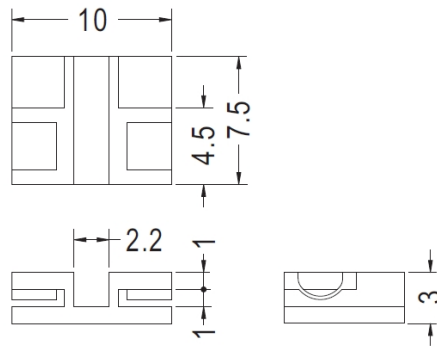
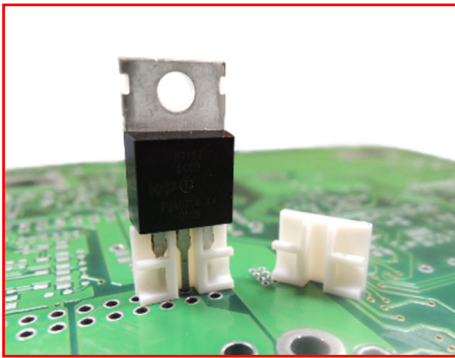

PART NO	PACKAGE
DTZ-56	1000

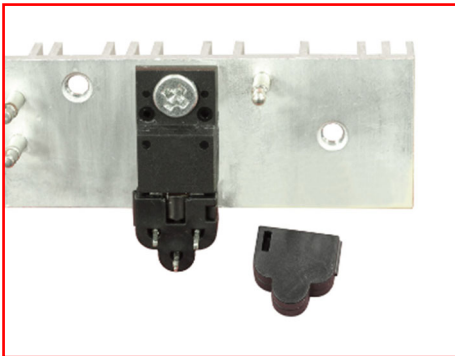

- ◆ MATERIAL : NYLON 66 (UL)
- ◆ FLAME CLASS : 94V-0/94V-2
- ◆ COLOR : NATURAL/BLACK
- ◆ UNIT: mm

用途：晶体管座，也称电晶体座，用于功率晶体之绝缘与防尘。

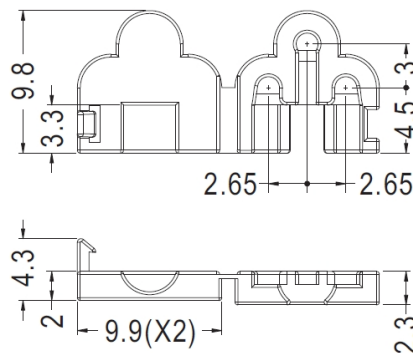

PART NO	PACKAGE
DTZ-59	1000

# 晶体管座 TRNASTOR HOUSING 电晶体座

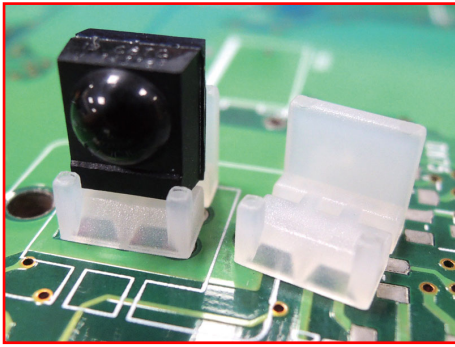

- ◆ MATERIAL : NYLON 66 (UL)
- ◆ FLAME CLASS : 94V-0/94V-2
- ◆ COLOR : NATURAL/BLACK
- ◆ UNIT: mm

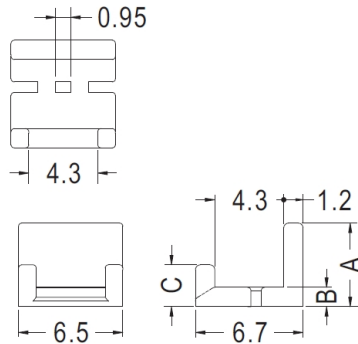

用途：晶体管座，也称电晶体座，保护IR晶体立于PC板上，使接脚不弯曲、折断、短路，且高度一致。

PART NO	A	B	C	PACKAGE
DTZ-60	5.2	1.2	2.6	1000
DTZ-61	6.0	2.0	3.4	1000
DTZ-63	9.3	5.3	6.7	1000

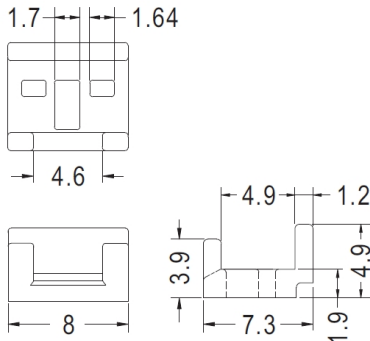
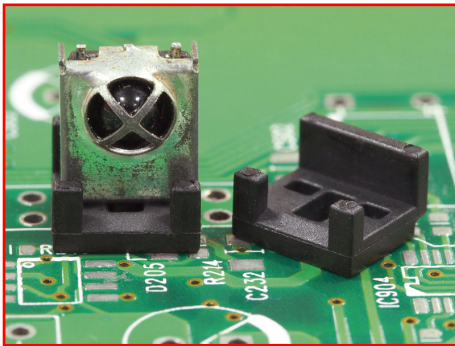

PART NO	PACKAGE
DTZ-62	1000

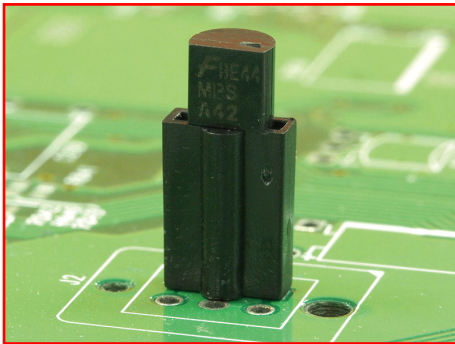

- ◆ MATERIAL : NYLON 66 (UL)
- ◆ FLAME CLASS : 94V-0/94V-2
- ◆ COLOR : NATURAL/BLACK
- ◆ UNIT: mm

用途：晶体管座，也称电晶体座，保护TO-92功率晶体立于PC板上，使接脚不弯曲、折断、短路、且高度一致。

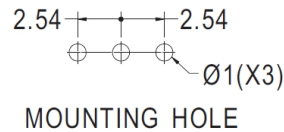
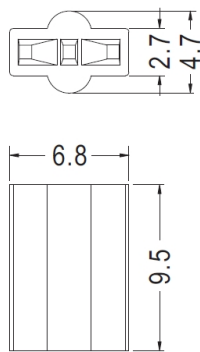

PART NO	PACKAGE
TO-92-2	1000



# 晶体管座 TRNASTOR HOUSING 电晶体座

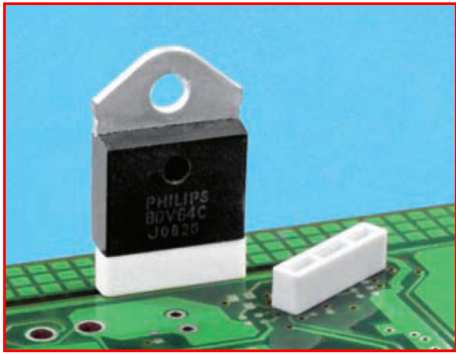

- ◆ MATERIAL : NYLON 66 (UL)
- ◆ FLAME CLASS : 94V-0/94V-2
- ◆ COLOR : NATURAL/BLACK
- ◆ UNIT: mm

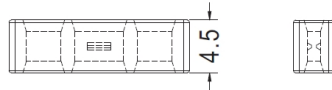
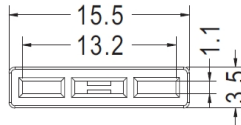
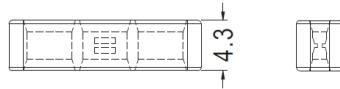
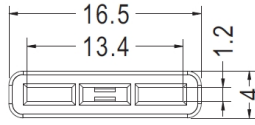

PART NO	PACKAGE
TO-247-3	1000

PART NO	PACKAGE
TO-247-4	1000

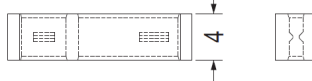
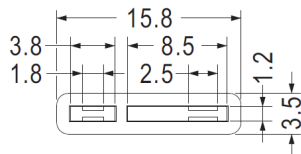

PART NO	PACKAGE
TO-247-5	1000

- ◆ MATERIAL : PBT (UL)
- ◆ FLAME CLASS : 94V-0
- ◆ COLOR : WHITE
- ◆ UNIT: mm

用途：晶体管座，也称电晶体座，适用于TO-247电晶体，保护晶体立于PC板上，使接脚不弯曲、折断、短路、且高度一致。

用途：晶体管座，也称电晶体座，保护晶体立于PC板上，使接脚不弯曲、折断、短路、且高度一致。

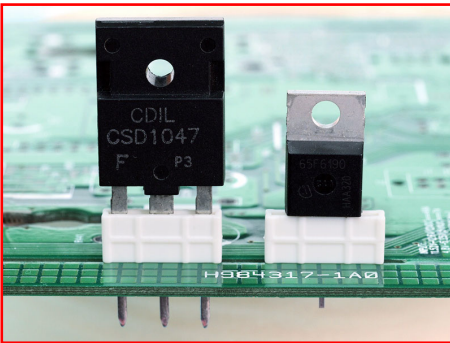

- ◆ MATERIAL : PBT (UL)
- ◆ FLAME CLASS : 94V-0
- ◆ COLOR : WHITE/NATURAL
- ◆ UNIT: mm

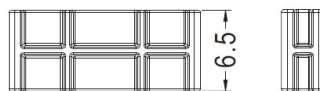
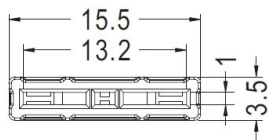

PART NO	PACKAGE
DTZ-68	1000

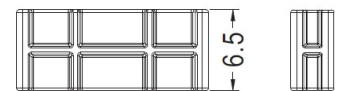
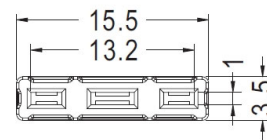

PART NO	PACKAGE
DTZ-77	1000

晶体管座

# 晶体管座 TRNASTOR HOUSING 电晶体座

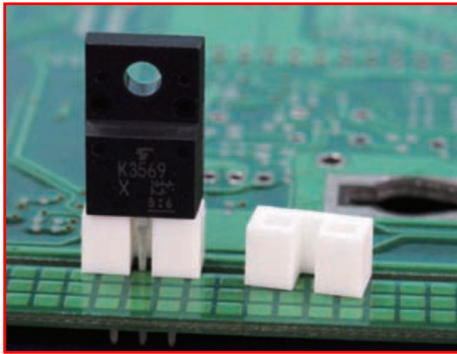

- ◆ MATERIAL : NYLON 66 (UL)
- ◆ FLAME CLASS : 94V-0/94V-2
- ◆ COLOR : NATURAL/BLACK
- ◆ UNIT: mm

用途：晶体管座，也称电晶体座，保护晶体立于PC板上，使接脚不弯曲、折断、短路，且高度一致。

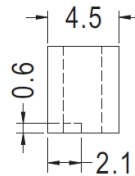
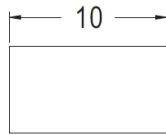
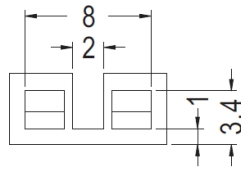

PART NO	PACKAGE
DTZ-72	1000

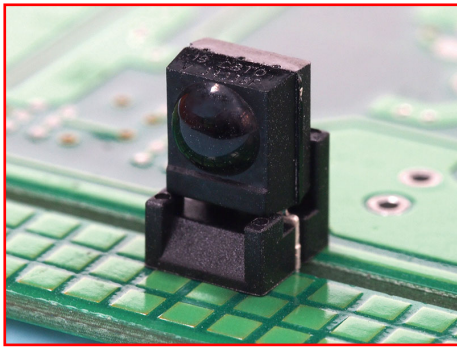

- ◆ MATERIAL : NYLON 66 (UL)
- ◆ FLAME CLASS : 94V-0/94V-2
- ◆ COLOR : NATURAL/BLACK
- ◆ UNIT: mm

用途：晶体管座，也称电晶体座，保护IR晶体立于PC板上，使接脚不弯曲、折断、短路，且高度一致。

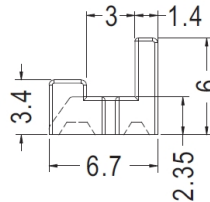
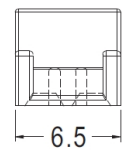
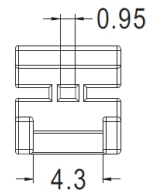

PART NO	PACKAGE
DTZ-74	1000

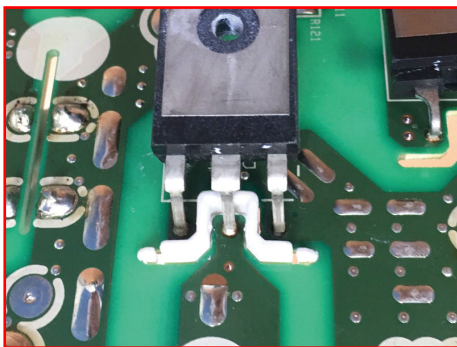

- ◆ MATERIAL : NYLON 66 (UL)
- ◆ FLAME CLASS : 94V-0/94V-2
- ◆ COLOR : NATURAL/BLACK/WHITE
- ◆ UNIT: mm

用途：晶体管座，也称电晶体座，保护IR晶体立于PC板上，使接脚不弯曲、折断、短路，且高度一致。

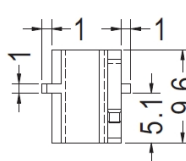
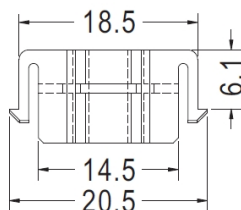
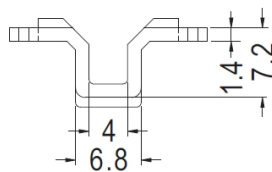

PART NO	PACKAGE
DTZ-76	1000

# 晶体管座 TRNASTOR HOUSING 电晶体座

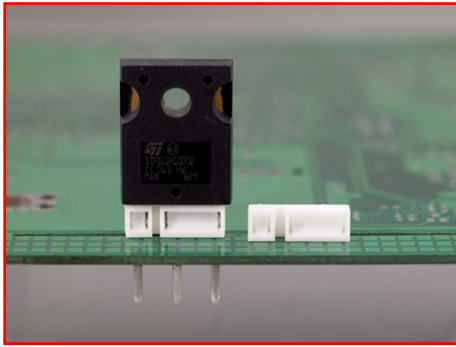

- ◆ MATERIAL : NYLON 66 (UL)
- ◆ FLAME CLASS : 94V-0/94V-2
- ◆ COLOR : NATURAL/BLACK
- ◆ UNIT: mm

用途：晶体管座，也称电晶体座，保护晶体立于PC板上，使接脚不弯曲、折断、短路、且高度一致。

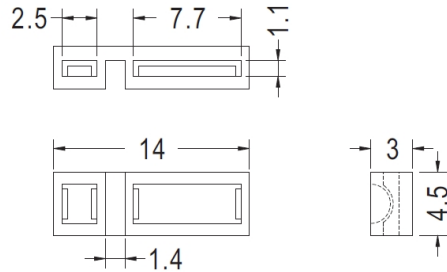

PART NO	PACKAGE
DTZ-80	1000



- ◆ MATERIAL : NYLON 66 (UL)
- ◆ FLAME CLASS : 94V-0/94V-2
- ◆ COLOR : NATURAL/BLACK
- ◆ UNIT: mm

用途：晶体管座，也称电晶体座，保护IR晶体立于PC板上，使接脚不弯曲、折断、短路、且高度一致。

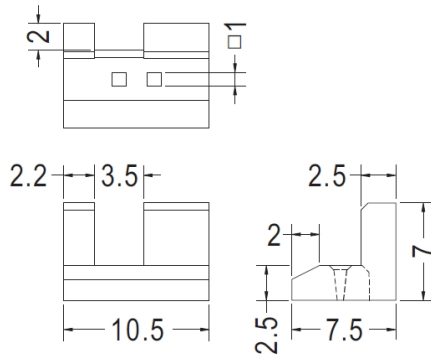

PART NO	PACKAGE
DTZ-81	1000



- ◆ MATERIAL : NYLON 66 (UL)
- ◆ FLAME CLASS : 94V-0/94V-2
- ◆ COLOR : NATURAL/BLACK
- ◆ UNIT: mm

用途：晶体管座，也称电晶体座，保护IR晶体立于PC板上，使接脚不弯曲、折断、短路、且高度一致。

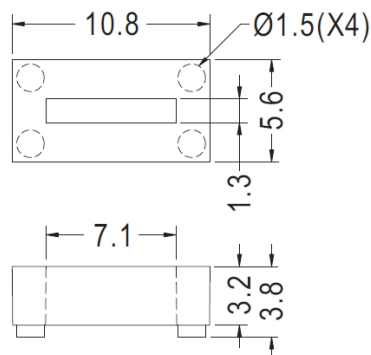

PART NO	PACKAGE
PAHO-014	1000

晶体管座





# TO-3晶体管座 TRNASTOR HOUSING TO-3电晶体座



- ◆ MATERIAL : NYLON 66 (UL)
- ◆ FLAME CLASS : 94V-0/94V-2
- ◆ COLOR : NATURAL/BLACK
- ◆ UNIT: mm

用途： TO-3晶体管座，也称TO-3电晶体座，锁于TO-3功率晶体与散热片之间，做为绝缘与保护之用。

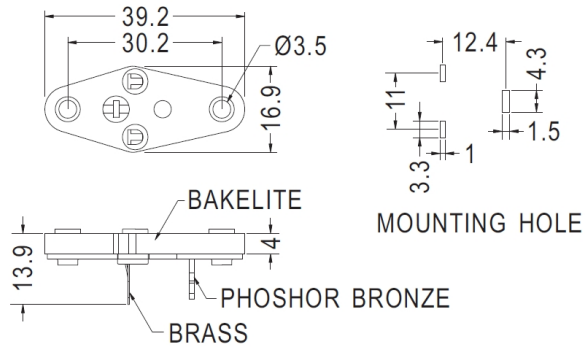

PART NO	PACKAGE
TO-3-K1	1000

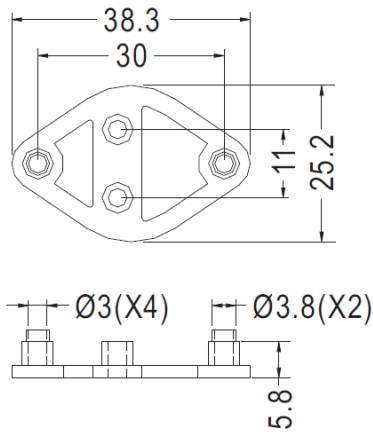

PART NO	PACKAGE
TO-3-K2	500

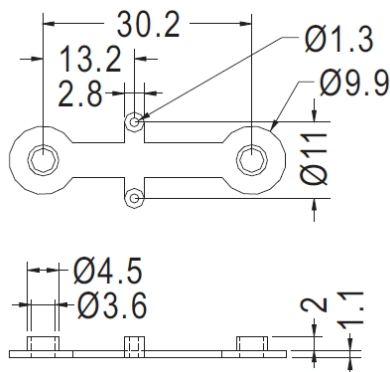

PART NO	PACKAGE
TO-3-K3	1000

TO-3晶体管座

# TO-3晶体管座 TRNASTOR HOUSING TO-3电晶体座



- ◆ MATERIAL : NYLON 66 (UL)
- ◆ FLAME CLASS : 94V-0/94V-2
- ◆ COLOR : NATURAL/BLACK
- ◆ UNIT: mm

用途： TO-3晶体管座，也称TO-3电晶体座，保护TO-3P功率晶体，保护晶体立于PC板上，使接脚不弯曲、折断、短路、且高度一致。

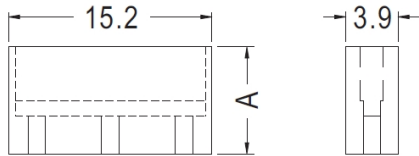
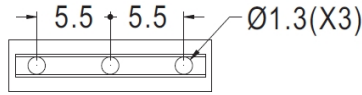

PART NO	A	PACKAGE
TO-3-K4	8.0	1000
TO-3-K5	10.0	1000

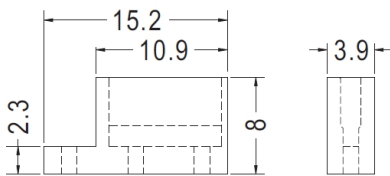
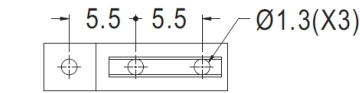

PART NO	PACKAGE
TO-3-K12	1000

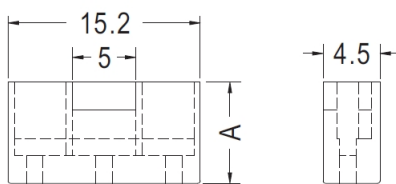
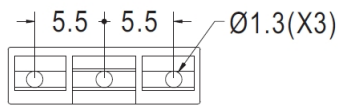
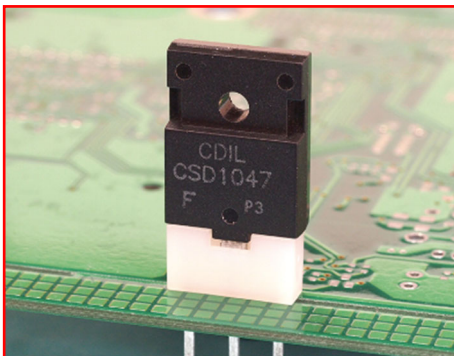

PART NO	A	PACKAGE
TO-3-K10	8.0	1000
TO-3-K11	10.0	1000

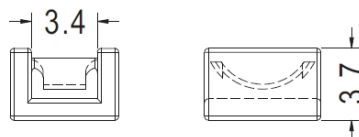
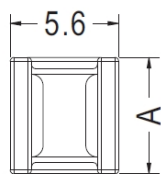
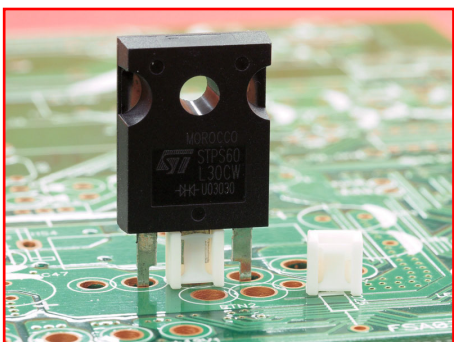

PART NO	A	PACKAGE
TO-3-K7	4.2	1000
TO-3-K8	6.0	1000
TO-3-K9	4.6	1000

TO-3晶体管座

# TO-3晶体管盖 TRNASTOR COVER TO-3电晶体盖

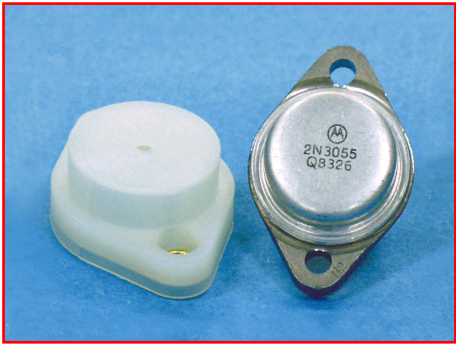

- ◆ MATERIAL : NYLON 66 (UL)
- ◆ FLAME CLASS : 94V-0/94V-2
- ◆ COLOR : NATURAL/BLACK
- ◆ UNIT: mm

用途： TO-3晶体管盖，也称TO-3电晶体盖，用于TO-3功率晶体之外壳绝缘。

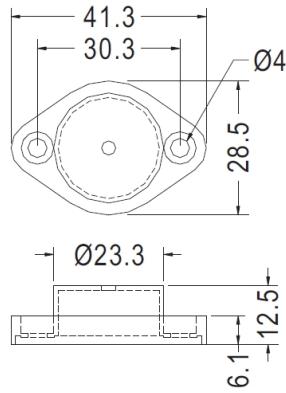

PART NO	PACKAGE
TO-3-K6	200

# 石英晶体垫片 CRYSTAL WASHER 垫圈 华司

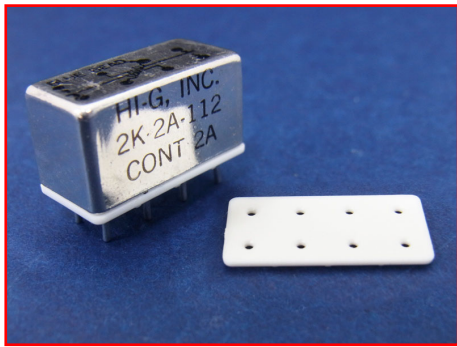

- ◆ MATERIAL : PBT (UL)
- ◆ FLAME CLASS : 94V-0
- ◆ COLOR : NATURAL
- ◆ UNIT: mm

用途：石英晶体垫片，保护石英震荡晶体立于PC板上外壳不会与PC板短路，且高度一致增加可靠度。

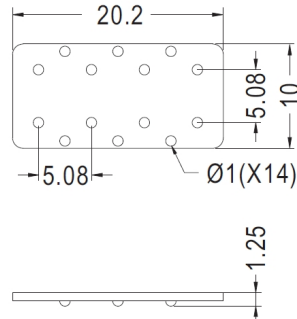

PART NO	PACKAGE
QCK-10	500

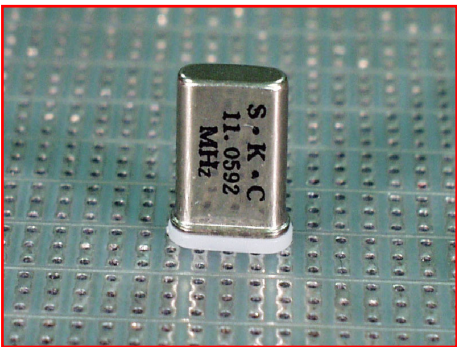

- ◆ MATERIAL : NYLON 66 (UL)
- ◆ FLAME CLASS : 94V-0/94V-2
- ◆ COLOR : NATURAL/BLACK
- ◆ UNIT: mm

用途：石英晶体垫片，保护石英震荡晶体立于PC板上外壳不会与PC板短路，且高度一致增加可靠度。

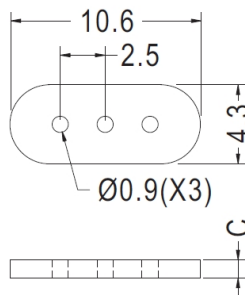

PART NO	A	PACKAGE
QCK-1	1.0	2000
QCK-8	0.5	2000

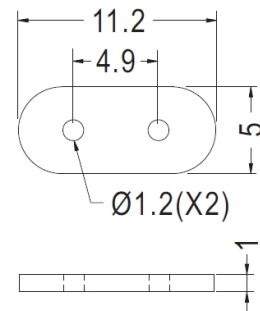

PART NO	PACKAGE
QCK-2	2000

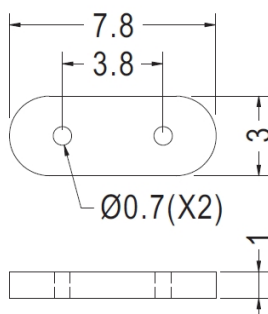

PART NO	PACKAGE
QCK-3	2000

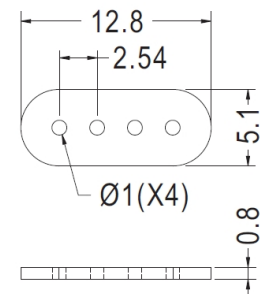

PART NO	PACKAGE
QCK-9	2000



# 石英晶体垫片 CRYSTAL WASHER 垫圈 华司

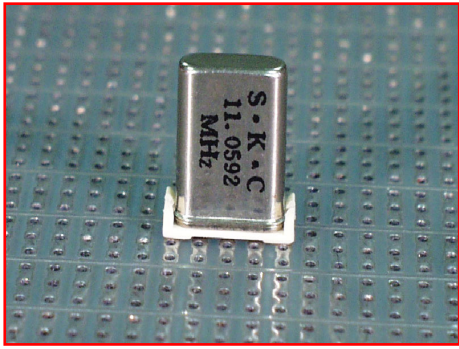

- ◆ MATERIAL : NYLON 66 (UL)
- ◆ FLAME CLASS : 94V-0/94V-2
- ◆ COLOR : NATURAL/BLACK
- ◆ UNIT: mm

用途：石英晶体垫片，保护石英震荡晶体立于PC板上外壳不会与PC板短路，且高度一致增加可靠度。

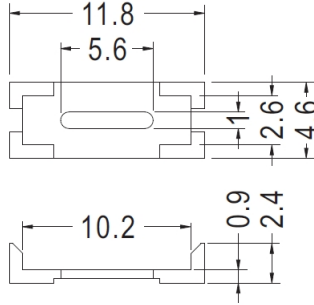

PART NO	PACKAGE
QCK-4	2000

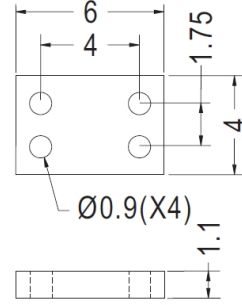

PART NO	PACKAGE
QCK-5	2000

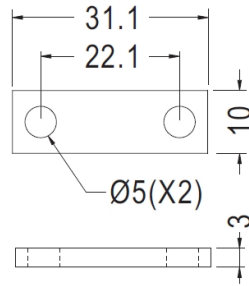

PART NO	PACKAGE
QCK-6	2000

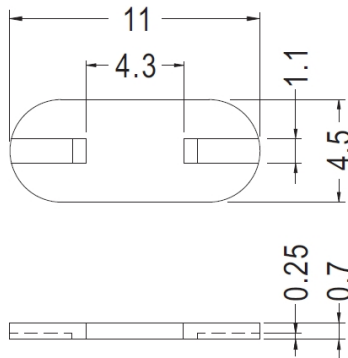
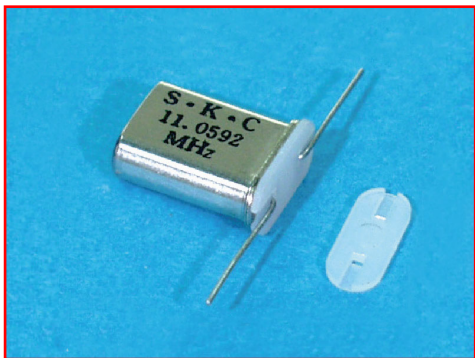

PART NO	PACKAGE
QCK-7	2000

石英晶体垫片

## TO-220晶体管座 TRNASTISOR HOUSING 电晶体座

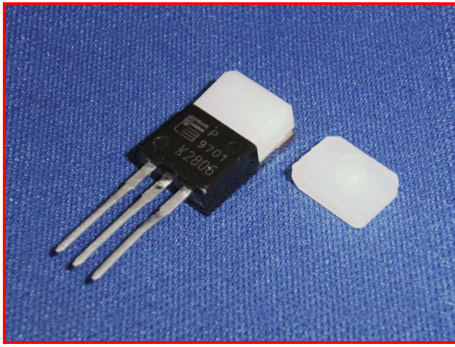

- ◆ MATERIAL : NYLON 66 (UL)
- ◆ FLAME CLASS : 94V-0/94V-2
- ◆ COLOR : NATURAL/BLACK
- ◆ UNIT: mm

用途： TO-220晶体管座，也称电晶体座，用于TO-220功率晶体组装。

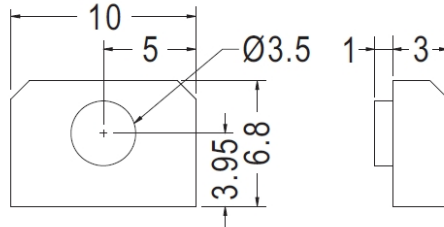

PART NO	PACKAGE
TO220-1	2000

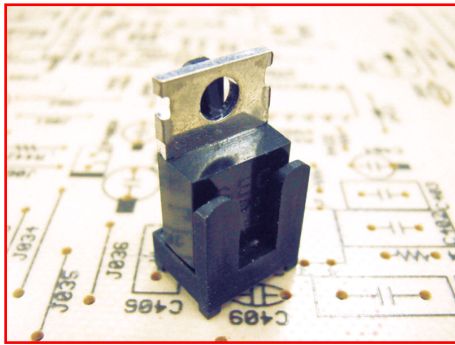

- ◆ MATERIAL : NYLON 66 (UL)
- ◆ FLAME CLASS : 94V-0/94V-2
- ◆ COLOR : NATURAL/BLACK
- ◆ UNIT: mm

用途： TO-220晶体管座，也称电晶体座，保护TO-220包装之晶体立于PC板上，使接脚不弯曲、折断、短路、且高度一致，增加可靠度。

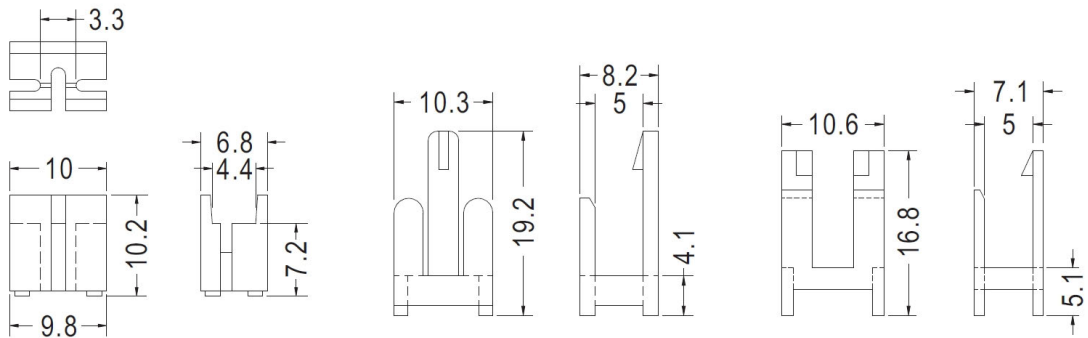

PART NO	PACKAGE
TO-220-T01	1000

PART NO	PACKAGE
TO-220-T02	1000

PART NO	PACKAGE
TO-220-T03	1000

# TO-220晶体管座 TRANSISTOR HOUSING 电晶体管座

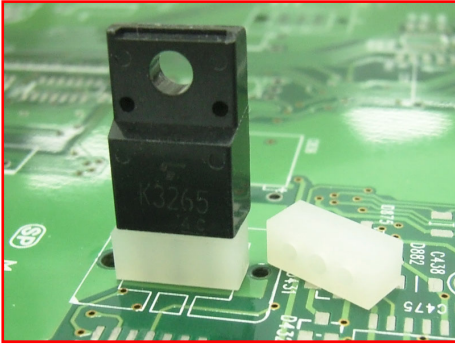

- ◆ MATERIAL : NYLON 66 (UL)
- ◆ FLAME CLASS : 94V-0/94V-2
- ◆ COLOR : NATURAL/BLACK
- ◆ UNIT: mm

用途： TO-220晶体管座，也称电晶体管座，保护TO-220包装之晶体管立于PC板上，使接脚不弯曲、折断、短路、且高度一致，增加可靠度。

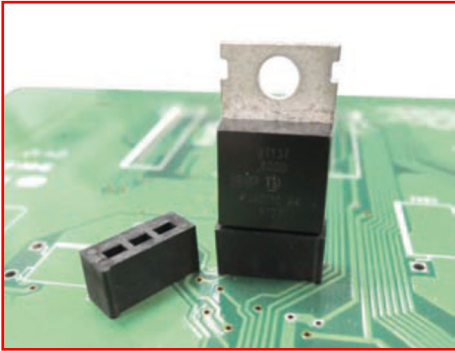
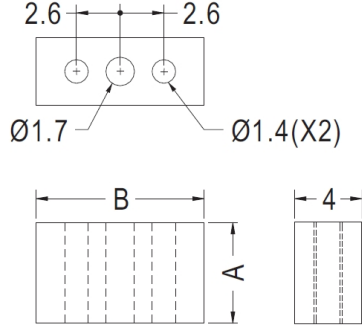

PART NO	A	B	PACKAGE
TO-220-T04	3.0	9.8	1000
TO-220-T05	3.7	9.8	1000
TO-220-T06	6.0	9.8	1000
TO-220-T07	4.0	9.8	1000
TO-220-T08	5.0	10.0	1000
TO-220-T09	7.0	9.8	1000
TO-220-T10	8.5	9.8	1000
TO-220-T11	9.0	9.8	1000
TO-220-T12	9.5	9.8	1000

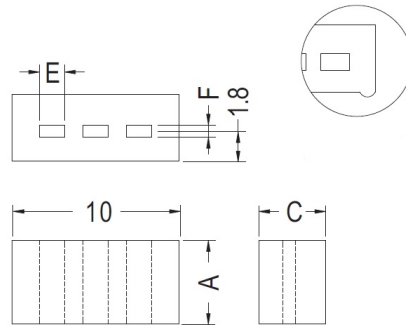
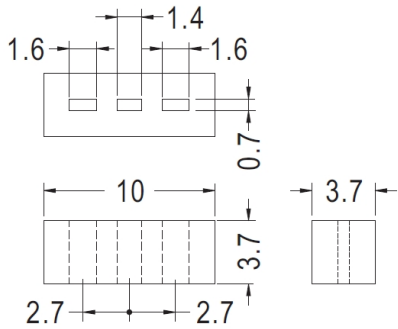

PART NO	PACKAGE
TO-220-T15	2000

PART NO	A	C	E	F	PACKAGE
TO-220-T13	5.0	4.0	1.5	0.75	1000
TO-220-T14	5.0	4.3	1.7	1.0	1000
TO-220-T16	3.0	3.0	1.5	0.75	1000

TO-220晶体管

# 光电晶体座 IR RECEIVER HOLDER 电晶体座

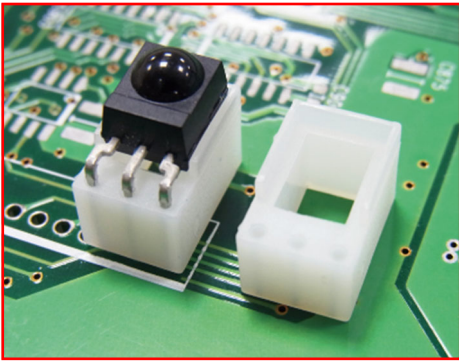

- ◆ MATERIAL : NYLON 66(UL)
- ◆ FLAME CLASS : 94V-2,94V-0
- ◆ COLOR : BLACK/NATURAL
- ◆ UNIT: mm

用途：光电晶体座，也称电晶体座，用于光晶体脚座，固定高度，可过锡炉，美观整齐。

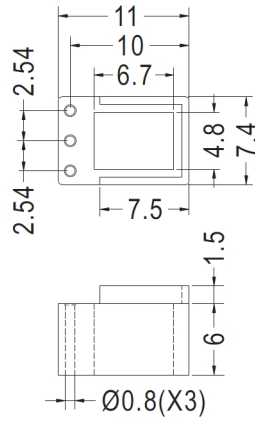

PART NO	PACKAGE
REH-1	1000

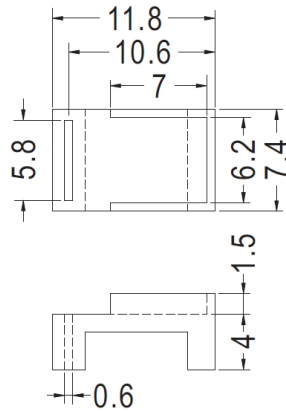

PART NO	PACKAGE
REH-7	1000

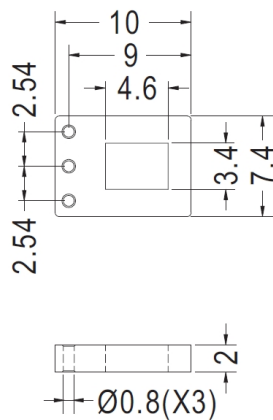
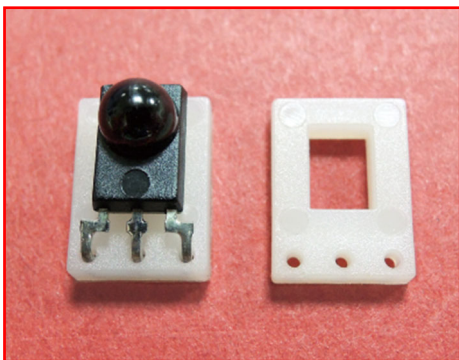

PART NO	PACKAGE
REH-2	1000

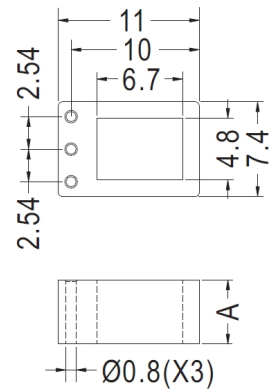

PART NO	A	PACKAGE
REH-3	3.0	1000
REH-4	5.0	1000
REH-5	6.0	1000
REH-6	12.6	1000



# 光电晶体座 IR RECEIVER HOLDER 电晶体座

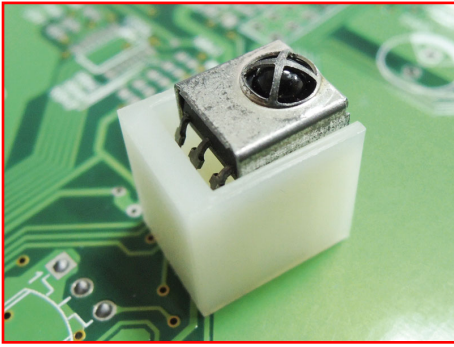

- ◆ MATERIAL : NYLON 66(UL)
- ◆ FLAME CLASS : 94V-2,94V-0
- ◆ COLOR : BLACK/NATURAL
- ◆ UNIT: mm

用途：光电晶体座，也称电晶体座，用于光晶体脚座，固定高度，可过锡炉，美观整齐。

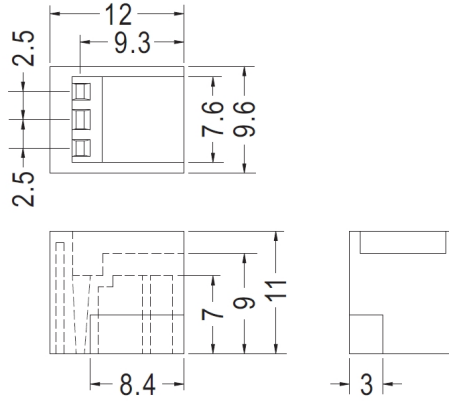

PART NO	PACKAGE
REH-8	1000

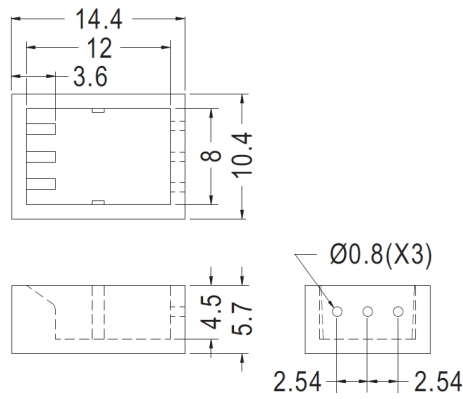
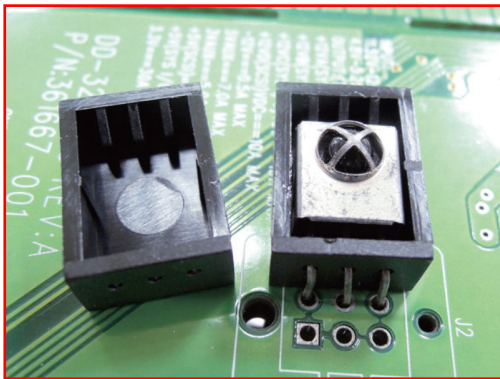

PART NO	PACKAGE
REH-16	1000

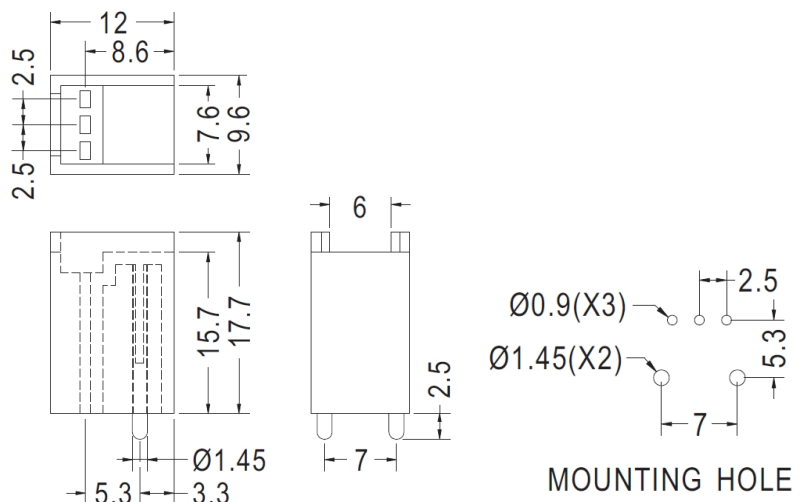
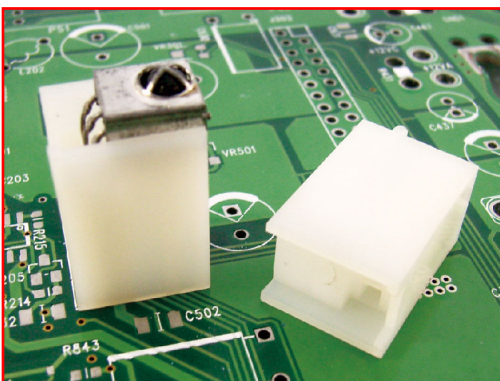

PART NO	PACKAGE
REH-9	1000

# 光电晶体座 IR RECEIVER HOLDER 电晶体座

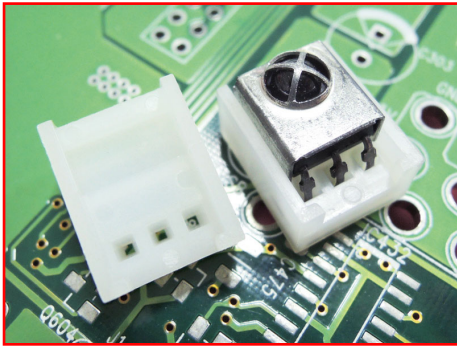

- ◆ MATERIAL : NYLON 66(UL)
- ◆ FLAME CLASS : 94V-2,94V-0
- ◆ COLOR : BLACK/NATURAL
- ◆ UNIT: mm

用途：光电晶体座，也称电晶体座，用于光晶体脚座，固定高度，可过锡炉，美观整齐。

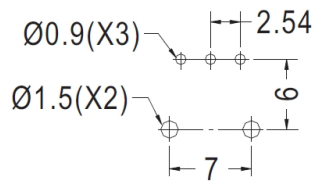
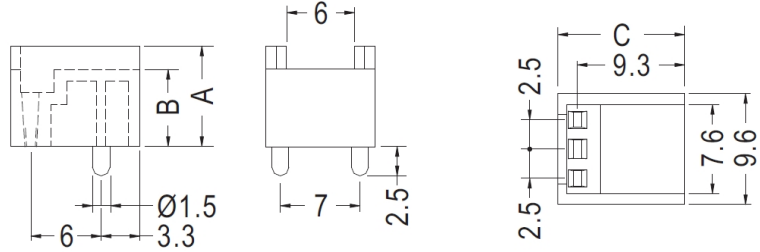

MOUNTING HOLE

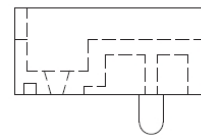

REH-10

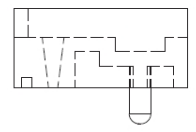

REH-20

PART NO	A	B	C	PACKAGE
REH-10	5.5	3.5	12.0	1000
REH-11	10.0	8.0	11.0	1000
REH-12	11.0	9.0	11.0	1000
REH-20	5.5	3.5	12.0	1000
REH-21	12.5	10.5	11.0	1000

光电晶体座

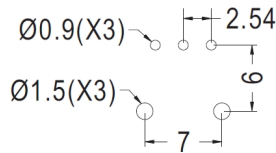
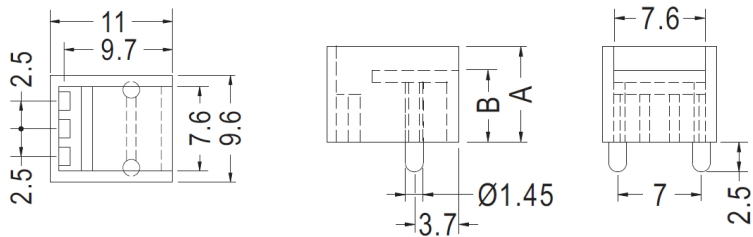
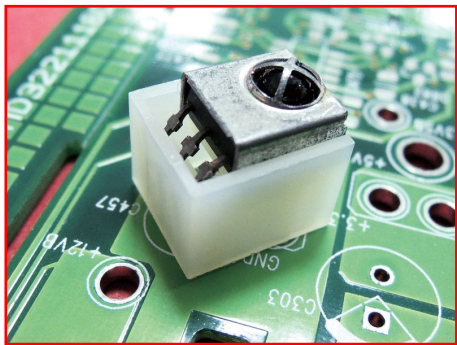

MOUNTING HOLE

PART NO	A	B	PACKAGE
REH-13	8.0	6.0	1000
REH-22	6.5	4.5	1000

# 光电晶体座 IR RECEIVER HOLDER 电晶体座

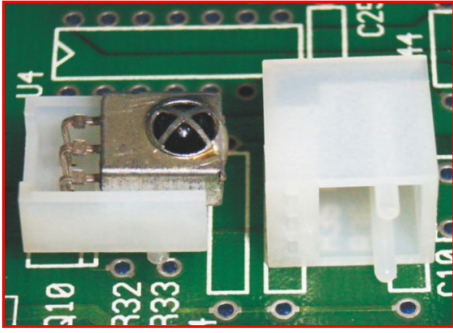

- ◆ MATERIAL : NYLON 66(UL)
- ◆ FLAME CLASS : 94V-2,94V-0
- ◆ COLOR : BLACK/NATURAL
- ◆ UNIT: mm

用途：光电晶体座，也称电晶体座，用于光晶体脚座，固定高度，可过锡炉，美观整齐。

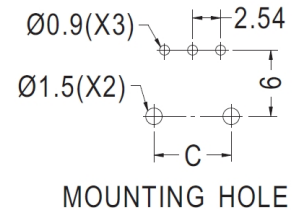
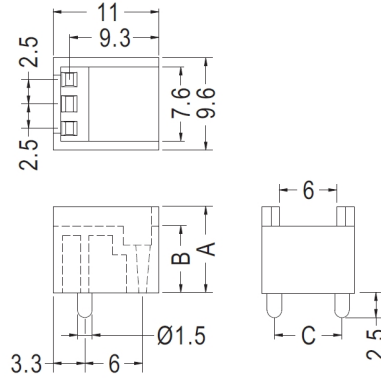

PART NO	A	B	C	PACKAGE
REH-14	9.0	7.0	7.0	1000
REH-15	17.0	15.0	6.0	1000

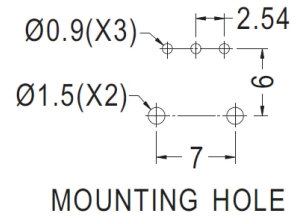
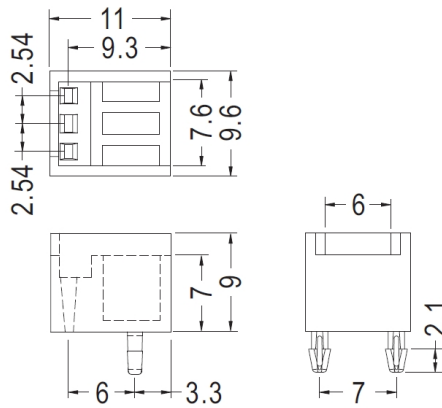
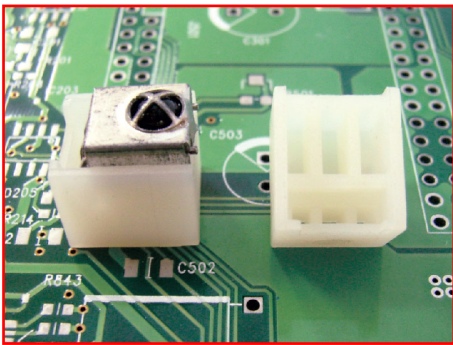

PART NO	PACKAGE
REH-17	1000

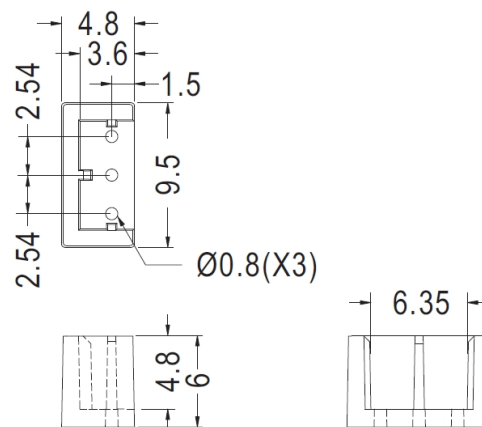
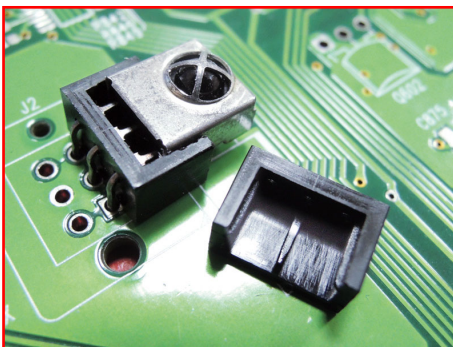

PART NO	PACKAGE
REH-18	1000

# 光电晶体座 IR RECEIVER HOLDER 电晶体座

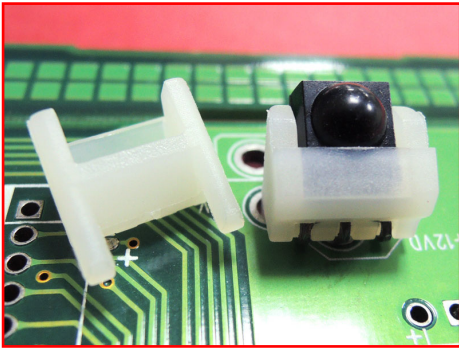

- ◆ MATERIAL : NYLON 66(UL)
- ◆ FLAME CLASS : 94V-2,94V-0
- ◆ COLOR : BLACK/NATURAL
- ◆ UNIT: mm

用途：光电晶体座，也称电晶体座，用于光晶体脚座，固定高度，可过锡炉，美观整齐。

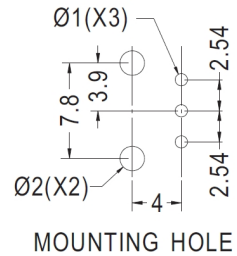
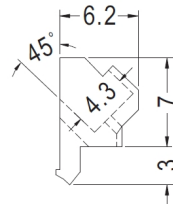
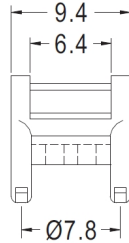

MOUNTING HOLE

PART NO	PACKAGE
REH-19	1000

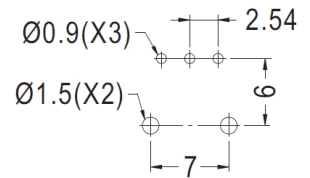
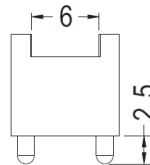
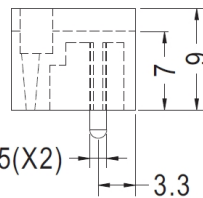
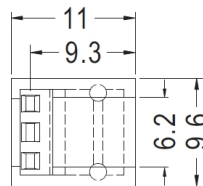
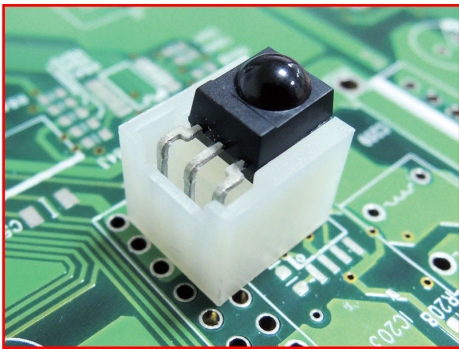

MOUNTING HOLE

PART NO	PACKAGE
REH-23	1000



# IR晶体座 IR RECEIVER HOLDER IR电晶体座

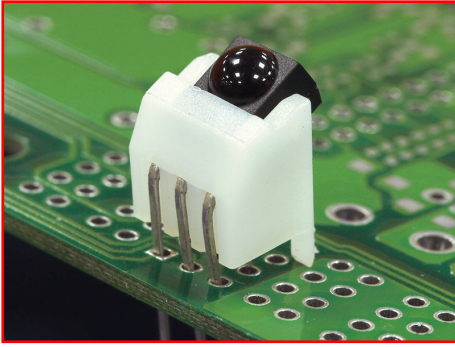

- ◆ MATERIAL : NYLON 66(UL)
- ◆ FLAME CLASS : 94V-2/94V-0
- ◆ COLOR : BLACK/NATURAL
- ◆ UNIT: mm

用途： IR晶体座，也称IR电晶体座，保护IR晶体立于PC板上，使接脚不弯曲、折断、短路，且高度一致。

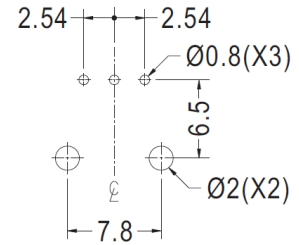
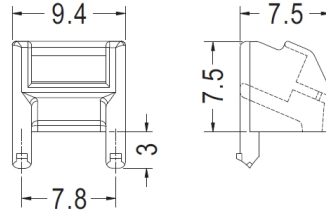

MOUNTING HOLE THICKNESS 1.6

PART NO	PACKAGE
IR-1	1000

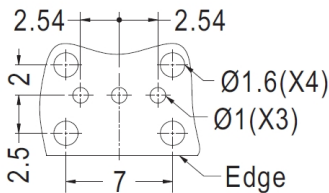
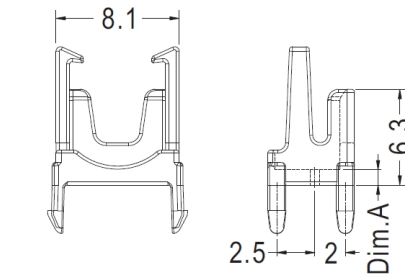
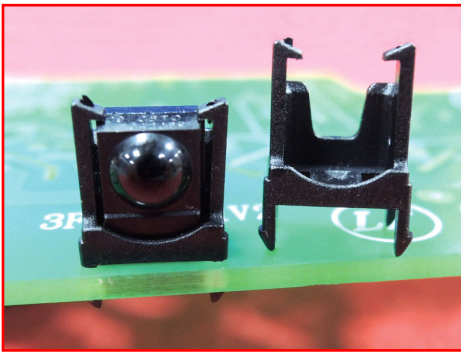

MOUNTING HOLE THICKNESS 1.6

PART NO	Dim.A	PACKAGE
IR-2	1.0	1000
IR-3	1.5	1000
IR-4	2.0	1000
IR-5	2.5	1000
IR-6	3.0	1000
IR-7	3.5	1000
IR-8	4.0	1000
IR-9	4.5	1000
IR-10	5.0	1000
IR-11	5.5	1000
IR-12	6.0	1000

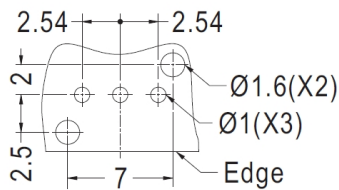
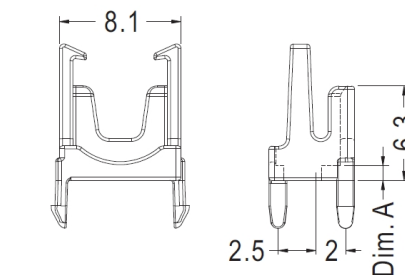
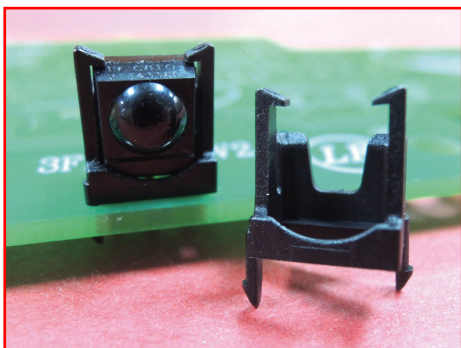

MOUNTING HOLE THICKNESS 1.6

PART NO	Dim.A	PACKAGE
IR-13	1.0	1000
IR-14	1.5	1000
IR-15	2.0	1000
IR-16	2.5	1000
IR-17	3.0	1000
IR-18	3.5	1000
IR-19	4.0	1000
IR-20	4.5	1000
IR-21	5.0	1000
IR-22	5.5	1000
IR-23	6.0	1000

IR晶体座

# IR晶体座 IR RECEIVER HOLDER IR电晶体座

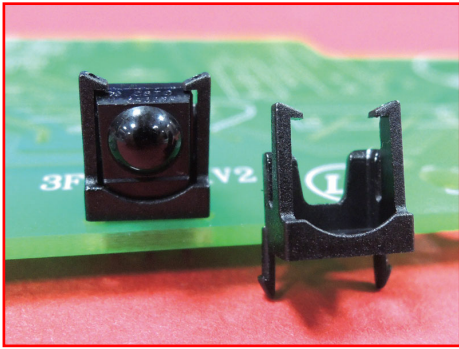

- ◆ MATERIAL : NYLON 66(UL)
- ◆ FLAME CLASS : 94V-2/94V-0
- ◆ COLOR : BLACK/NATURAL
- ◆ UNIT: mm

用途: IR晶体座, 也称IR电晶体座, 保护IR晶体立于PC板上, 使接脚不弯曲、折断、短路, 且高度一致。

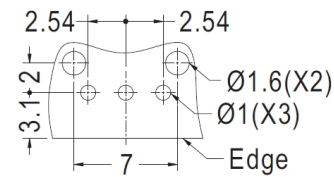
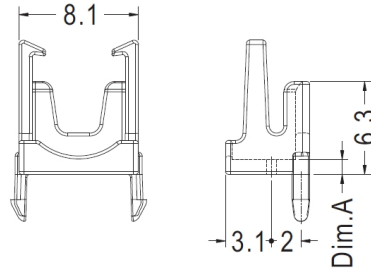

MOUNTING HOLE THICKNESS 1.6

PART NO	Dim.A	PACKAGE
IR-24	1.0	1000
IR-25	1.5	1000
IR-26	2.0	1000
IR-27	2.5	1000
IR-28	3.0	1000
IR-29	3.5	1000
IR-30	4.0	1000
IR-31	4.5	1000
IR-32	5.0	1000
IR-33	5.5	1000
IR-34	6.0	1000

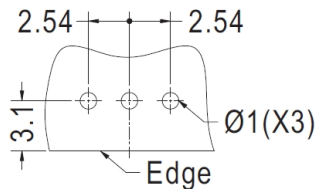
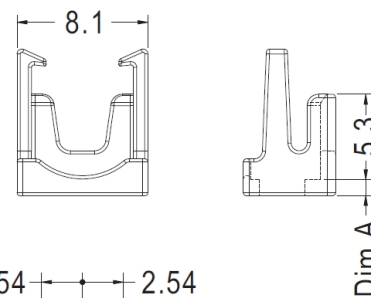
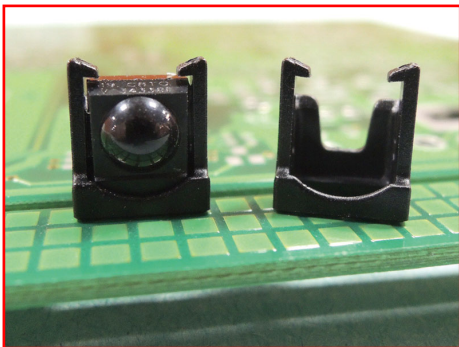

MOUNTING HOLE THICKNESS 1.6

PART NO	Dim.A	PACKAGE
IR-36	1.0	1000
IR-37	1.5	1000
IR-38	2.0	1000
IR-39	2.5	1000
IR-40	3.0	1000
IR-41	3.5	1000
IR-42	4.0	1000
IR-44	5.0	1000
IR-46	6.0	1000
IR-47	4.5	1000
IR-48	5.5	1000
IR-49	7.0	1000

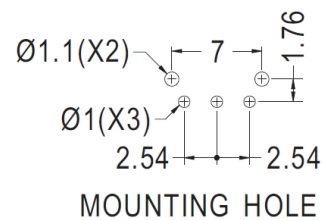
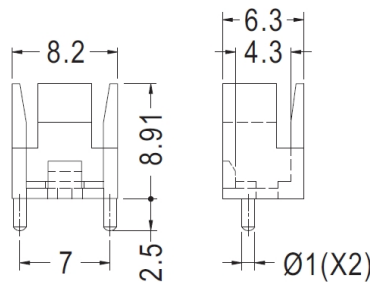
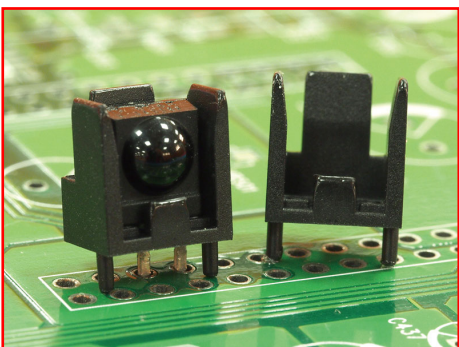

MOUNTING HOLE

PART NO	PACKAGE
IR35	1000

# IR晶体管座 IR RECEIVER HOUSING

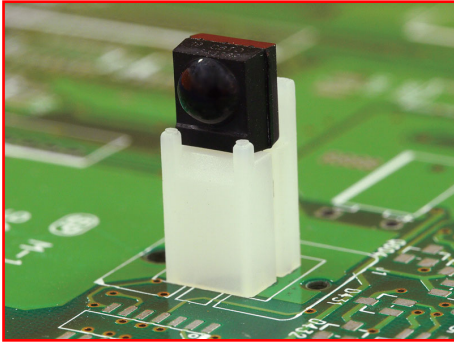

- ◆ MATERIAL : NYLON 66(UL)
- ◆ FLAME CLASS : 94V-2/94V-0
- ◆ COLOR : BLACK/NATURAL
- ◆ UNIT: mm

用途： IR晶体管座，保护IR晶体立于PC板上，使接脚不弯曲、折断、短路，且高度一致。

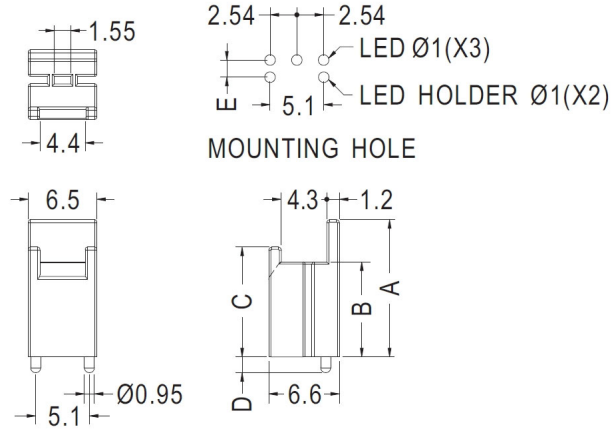

PART NO	A	B	C	D	E	PACKAGE
IR-50	13.0	9.0	10.4	1.5	1.6	1000
IR-51	14.8	10.8	12.2	0.9	2.4	1000

# 霍尔晶体座 HALL SENSOR HOUSING

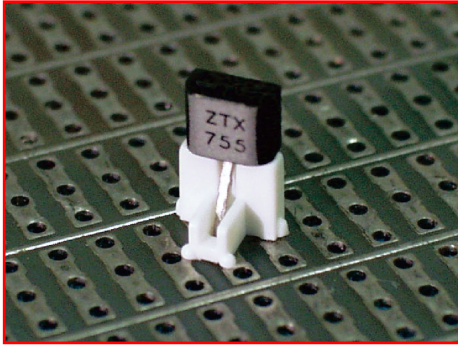

- ◆ MATERIAL : NYLON 66(UL)
- ◆ FLAME CLASS : 94V-2/94V-0
- ◆ COLOR : BLACK/NATURAL
- ◆ UNIT: mm

用途：霍尔晶体座，保护霍尔晶体立于PC板上，使接脚不弯曲、折断、短路，且高度一致。

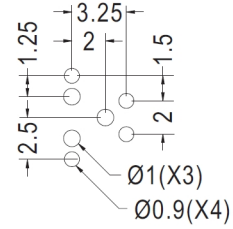
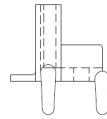
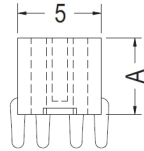
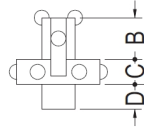

MOUNTING HOLE

PART NO	A	B	C	D	PACKAGE
HLS-1	4.6	2.5	1.5	1.5	2000
HLS-2	10.5	2.4	1.7	1.4	2000



# 硅胶帽套 SILICON INSULATOR COVER

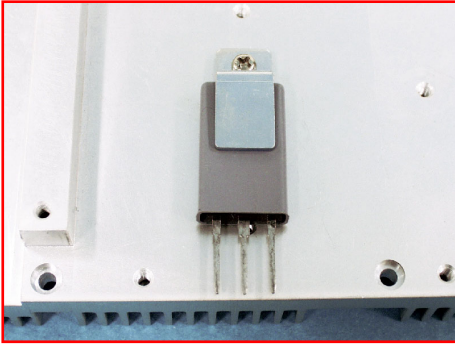

- ◆ MATERIAL : SILICON (UL)
- ◆ FLAME CLASS : 94HB/94V-0
- ◆ COLOR : GRAY
- ◆ UNIT: mm

用途：硅胶帽套，固定于功率晶体与散热片之间，绝缘性特佳。

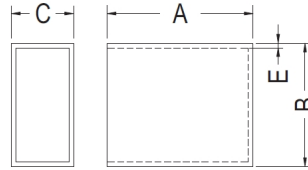

PART NO	A	B	C	E	PACKAGE
RUCT-5	16.0	11.4	5.5	0.45	1000
RUCT-6	28.5	18.0	6.4	0.75	1000
RUCT-7	35.0	20.0	6.4	0.75	1000

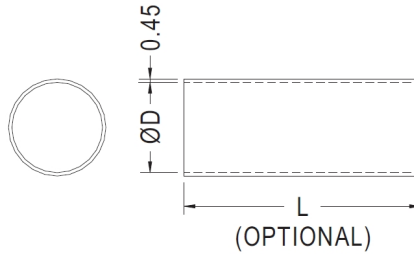
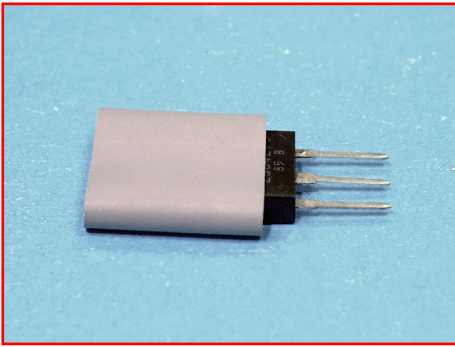

PART NO	D
RUCT-8	6.0
RUCT-9	8.0
RUCT-10	10.0
RUCT-11	12.0
RUCT-12	14.0
RUCT-13	16.0
RUCT-14	18.0

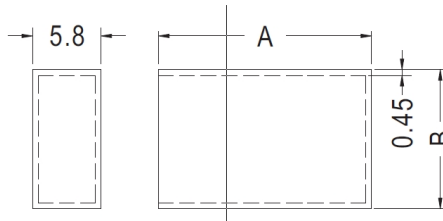
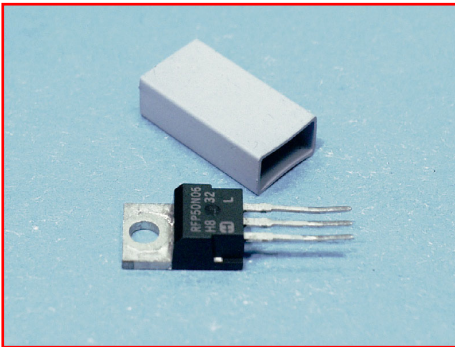

PART NO	A	B	PACKAGE
RUCT-16	28.5	17.5	1000
RUCT-17	25.0	17.5	1000
RUCT-18	21.7	11.5	1000

# 功率晶体导热硅胶片 Transistor Thermal Conductive Pad

用途：功率晶体导热硅胶片，用于功率晶体之导热和绝缘。可依客户指定长、宽、高裁切成各种形状，如方形、圆形。

- ◆ MATERIAL : SILICON (UL)
- ◆ FLAME CLASS : 94V-0
- ◆ COLOR : GRAY
- ◆ UNIT: mm

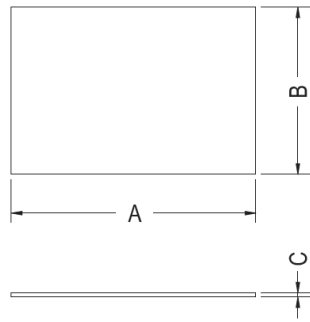
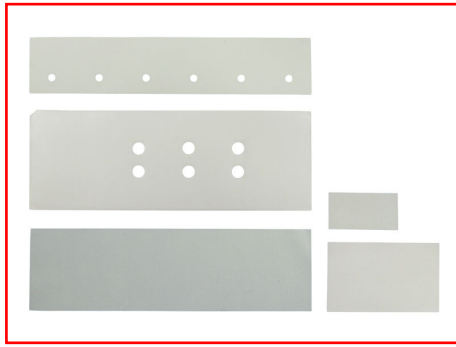

PART NO	A	B	C	PACKAGE
TSI-1	19.0	13.0	0.3	20000
TSI-2	21.0	12.5	0.3	5000
TSI-3	25.0	19.0	0.3	20000
TSI-4	30.0	12.0	0.3	20000
TSI-5	30.0	30.0	0.3	5000
TSI-6	45.0	20.5	0.3	5000
TSI-7	48.0	30.0	0.23	3000
TSI-8	300.0	200.0	0.3	500

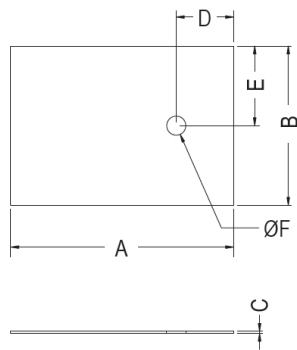

PART NO	A	B	C	D	E	F	PACKAGE
TSI-9	30.0	23.0	0.3	15.0	10.4	3.0	5000
TSI-10	30.0	30.0	0.45	15.0	15.0	4.5	5000
TSI-11	35.0	25.0	0.3	9.0	12.5	3.0	5000

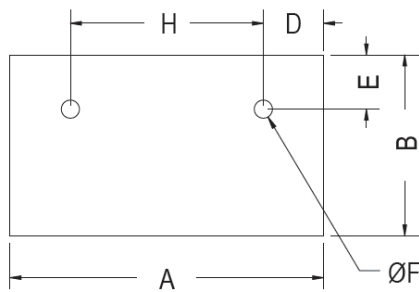

PART NO	A	B	C	D	E	F	PACKAGE
TSI-12	30.5	17.8	0.3	6.4	8.9	3.1	10000
TSI-13	33.5	12.5	0.3	5.75	7.0	3.0	3000
TSI-14	34.0	13.0	0.3	5.0	6.5	5.8	5000
TSI-15	52.0	30.0	0.3	10.0	9.0	3.0	5000
TSI-16	75.0	28.0	0.45	27.0	7.5	3.2	3000

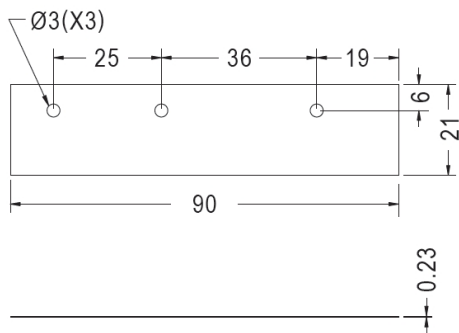

PART NO	PACKAGE
TSI-17	5000

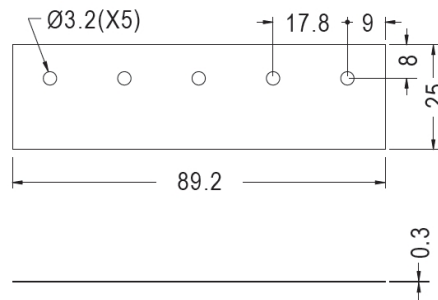

PART NO	PACKAGE
TSI-18	5000

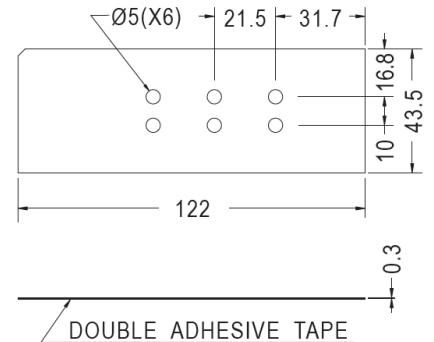

PART NO	PACKAGE
TSI-19	3000

# 功率晶体压板 POWER TRANSISTOR CLAMP DEPRESSOR 电源固定压条



- ◆ MATERIAL : NYLON 66(UL)
- ◆ FLAME CLASS : 94V-2,94V-0
- ◆ COLOR : BLACK
- ◆ UNIT: mm

用途：功率晶体压板,可将功率晶体快速固定于散热片上，方便、耐高压。

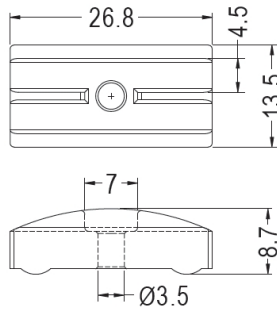

PART NO	PACKAGE
TRNK10	500

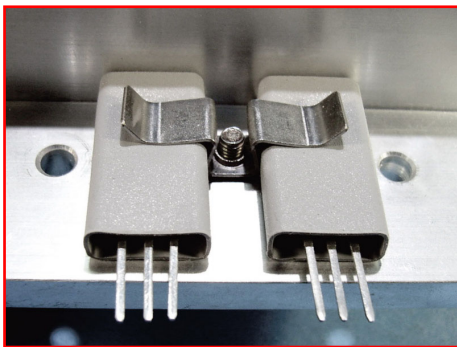

- ◆ MATERIAL : SUS
- ◆ UNIT: mm

用途：功率晶体压板,可将功率晶体快速固定于散热片上，方便、耐高压。

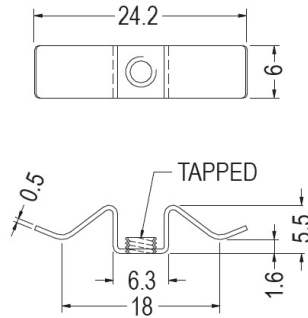

PART NO	TAPPED	PACKAGE
TRNK03	M3X0.5P	1000
TRNK04	M4X0.8P	1000
TRNK05	6-32 UNC	1000

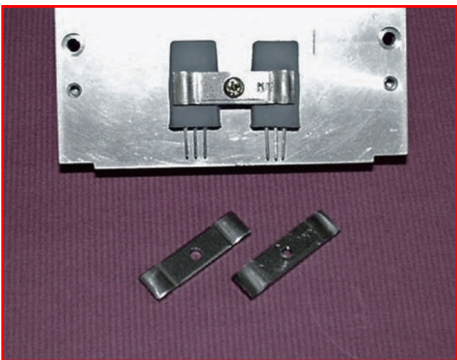

- ◆ MATERIAL : ZINC PLATED STEEL
- ◆ UNIT: mm

用途：功率晶体压板,可将功率晶体快速固定于散热片上，方便、耐高压。

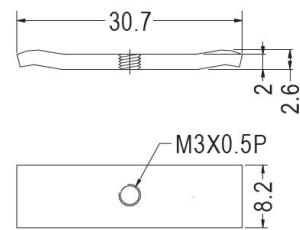
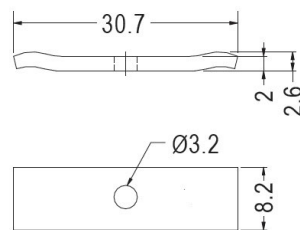

PART NO	PACKAGE
TRNK12	500

PART NO	PACKAGE
TRNK13	500



- ◆ MATERIAL : ZINC PLATED SK5
- ◆ UNIT: mm

用途：功率晶体压板,可将功率晶体快速固定于散热片上，方便、耐高压。

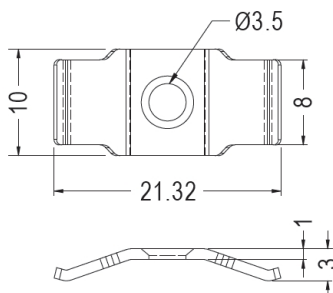

PART NO	PACKAGE
TRNK07	1000

# 功率晶体压板 POWER TRANSISTOR CLAMP DEPRESSOR 电源固定压条



- ◆ MATERIAL : SUS
- ◆ UNIT: mm

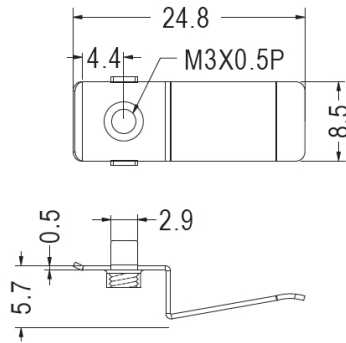

用途：功率晶体压板,可将功率晶体快速固定于散热片上，方便、耐高压。

PART NO	PACKAGE
TRNK08	1000

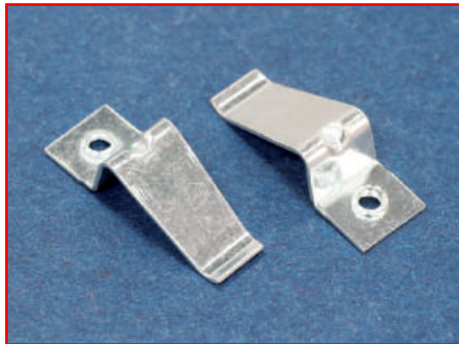

- ◆ MATERIAL : SPRING STAINLESS
- ◆ FINISH : ZINC PLATED
- ◆ UNIT: mm

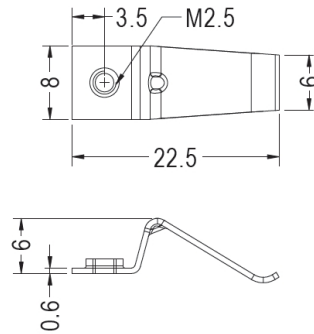

用途：功率晶体压板,可将功率晶体快速固定于散热片上，方便、耐高压。

PART NO	PACKAGE
TRNK18	500



- ◆ MATERIAL : SUS
- ◆ UNIT: mm

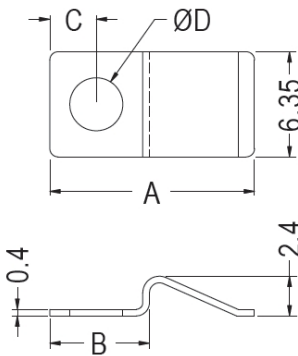

用途：功率晶体压板,可将功率晶体快速固定于散热片上，方便、耐高压。

PART NO	A	B	C	D	PACKAGE
TRNK09	12.33	6.0	2.8	3.2	2000
TRNK16	12.73	6.8	3.2	3.4	2000



- ◆ MATERIAL : ZINC PLATED STEEL
- ◆ UNIT: mm

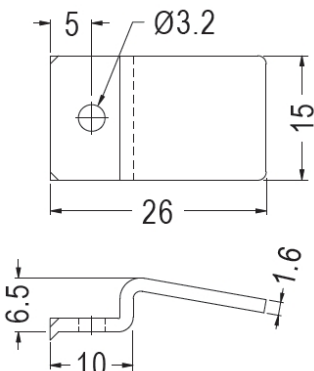

用途：功率晶体压板,可将功率晶体快速固定于散热片上，方便、耐高压。

PART NO	PACKAGE
TRNK15	1000



# 功率晶体压板 POWER TRANSISTOR CLAMP DEPRESSOR 电源固定压条



- ◆ MATERIAL : SUS
- ◆ UNIT: mm

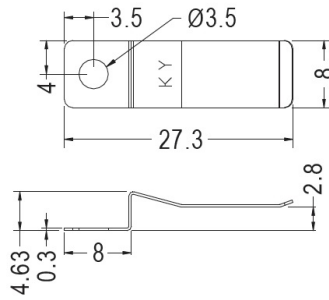

用途：功率晶体压板,可将功率晶体快速固定于散热片上,方便、耐高压。

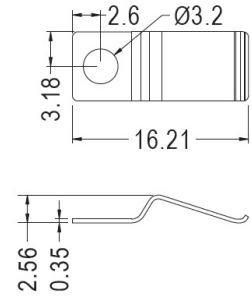

PART NO	PACKAGE
TRNK11	1000

PART NO	PACKAGE
TRNK17	1000

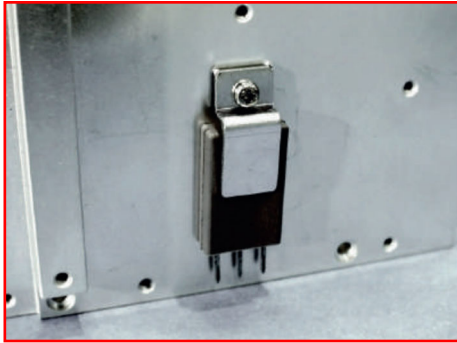

- ◆ MATERIAL : ZINC PLATED STEEL
- ◆ UNIT: mm

用途：功率晶体压板,可将功率晶体快速固定于散热片上,方便、耐

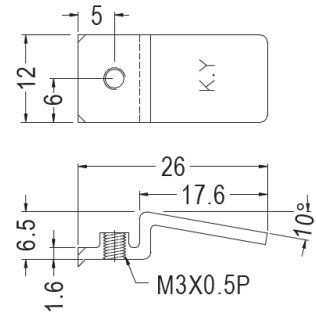
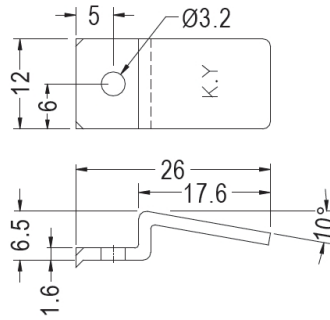

PART NO	PACKAGE
TRNK01	250

PART NO	PACKAGE
TRNK02	250

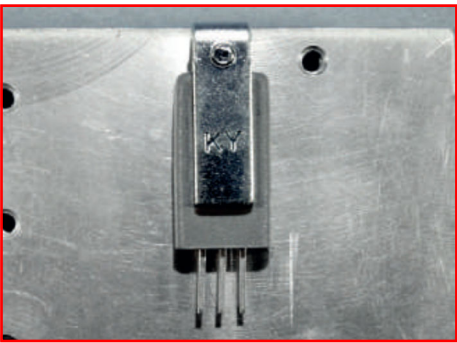

- ◆ MATERIAL : ZINC PLATED SPCC
- ◆ UNIT: mm

用途：功率晶体压板,可将功率晶体快速固定于散热片上,方便、耐高压。

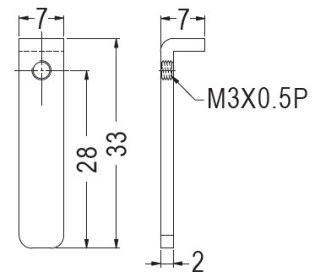
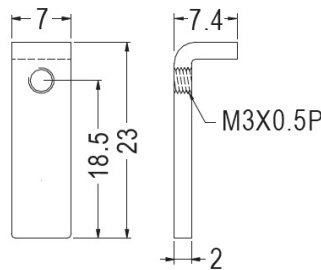

PART NO	PACKAGE
TRNK06	500

PART NO	PACKAGE
TRNK14	500

功率晶体压板

# 压板 DEPRESSOR 电源固定压条



- ◆ MATERIAL : NYLON 66(UL) 94V-2 用途: 功率晶体压板,用于压着电子零件或功率晶体。
- ◆ MATERIAL : SUS
- ◆ COLOR : BLACK
- ◆ UNIT: mm

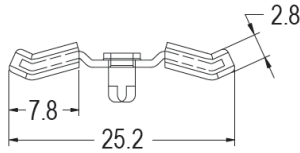
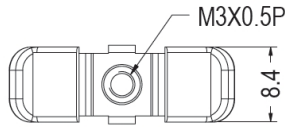

PART NO	PACKAGE
LTRK-1	1000

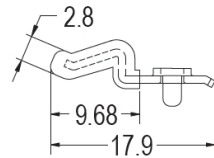
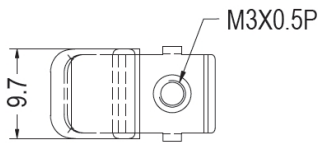
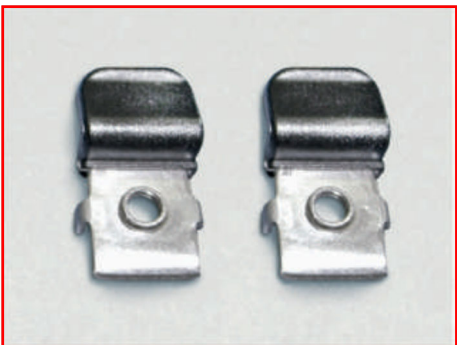

PART NO	PACKAGE
LTRK-2	1000

功率晶体压板

# 晶体管固定弹片 TRANSISTOR CLAMP 五金弹片 电晶体固定弹片



- ◆ MATERIAL : SUS
- ◆ UNIT: mm

用途：晶体管固定弹片，也称五金弹片，可将功率晶体快速固定于散热片上，方便、耐高压。

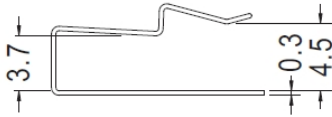

PART NO	PACKAGE
TRMC-G14	1000

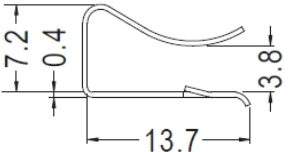

PART NO	PACKAGE
TRMC-G15	1000

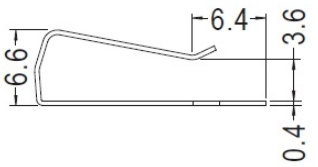

PART NO	PACKAGE
TRMC-G20	1000

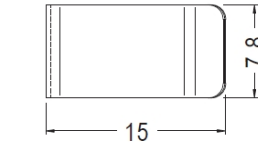
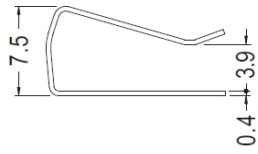
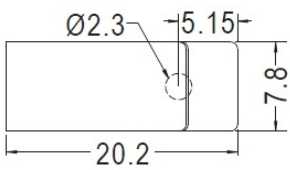

PART NO	PACKAGE
TRMC-G01	1000

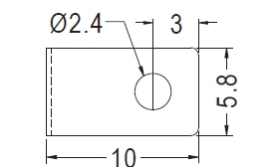
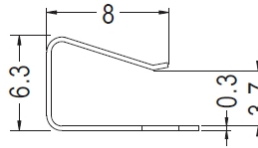

PART NO	PACKAGE
TRMC-G05	1000

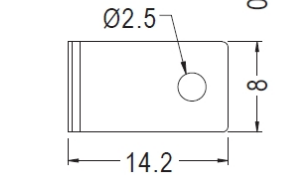
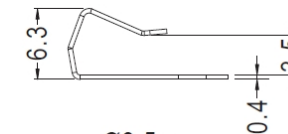

PART NO	PACKAGE
TRMC-G08	1000

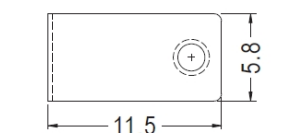
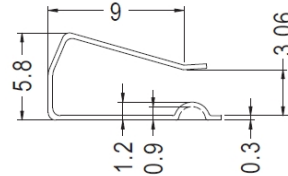

PART NO	PACKAGE
TRMC-G11	1000

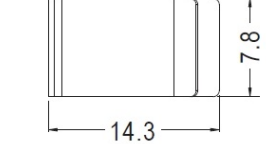
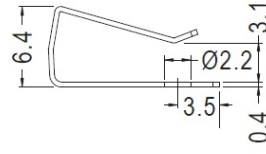

PART NO	PACKAGE
TRMC-G02	1000

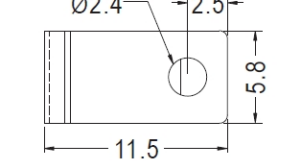
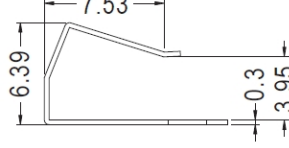

PART NO	PACKAGE
TRMC-G06	1000

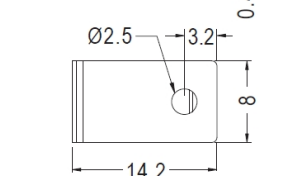
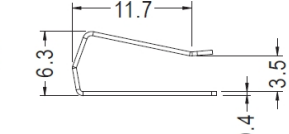

PART NO	PACKAGE
TRMC-G09	1000

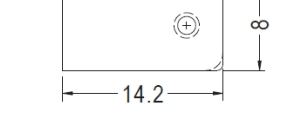
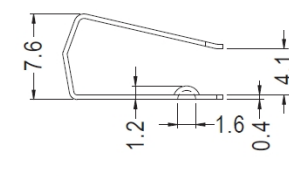

PART NO	PACKAGE
TRMC-G12	1000

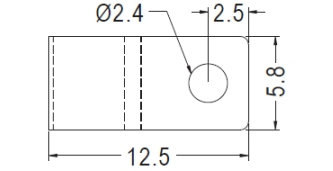
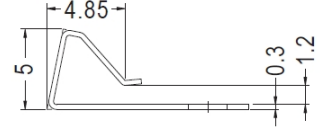

PART NO	PACKAGE
TRMC-G04	1000

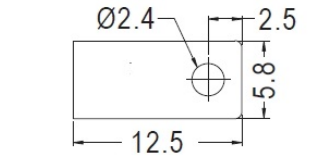
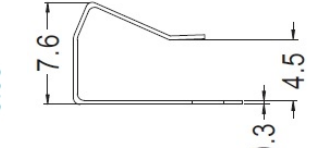

PART NO	PACKAGE
TRMC-G07	1000

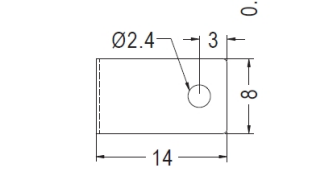
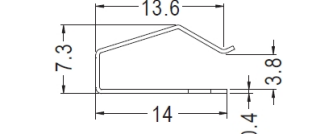

PART NO	PACKAGE
TRMC-G10	1000

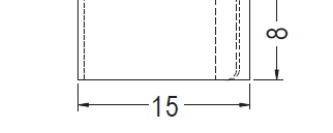
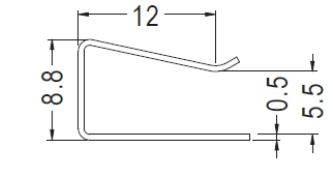

PART NO	PACKAGE
TRMC-G13	1000

晶体管固定弹片

# 晶体管固定弹片 TRANSISTOR CLAMP 五金弹片 电晶体固定弹片



- ◆ MATERIAL : SUS
- ◆ UNIT: mm

用途：晶体管固定弹片，也称五金弹片，可将功率晶体快速固定于散热片上，方便、耐高压。

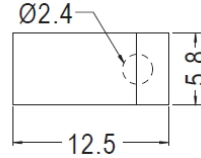
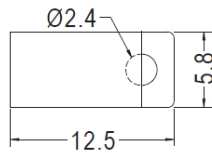
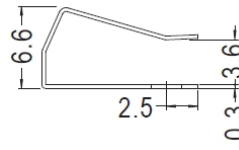
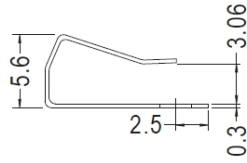

PART NO	PACKAGE
TRMC-G21	1000

PART NO	PACKAGE
TRMC-G22	1000

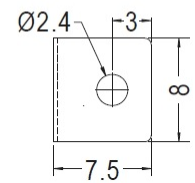
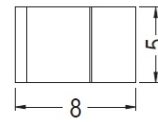
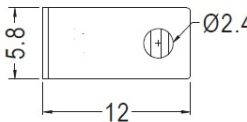
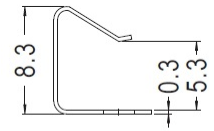
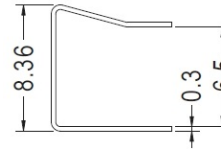
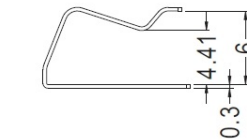
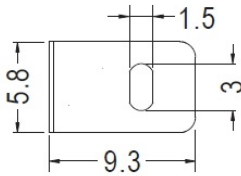
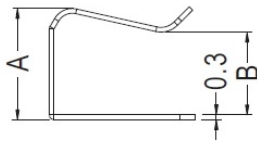

PART NO	A	B	PACKAGE
TRMC-G25	7.1	5.3	1000
TRMC-G26	7.22	5.35	1000

PART NO	PACKAGE
TRMC-G24	1000

PART NO	PACKAGE
TRMC-G29	1000

PART NO	PACKAGE
TRMC-G23	1000

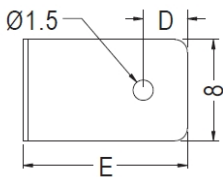
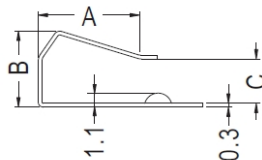

PART NO	A	B	C	D	E	PACKAGE
TRMC-G16	8.0	6.1	3.5	3.5	13.0	1000
TRMC-G17	6.9	7.5	4.5	4.0	11.0	1000
TRMC-G18	6.9	8.5	5.8	4.0	11.0	1000

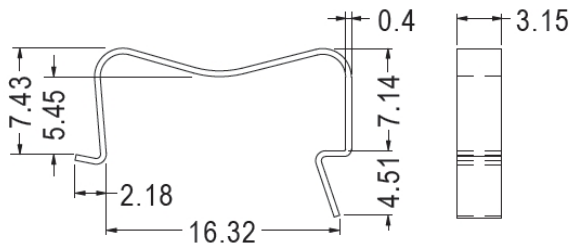

GNTE-40	PACKAGE
TRMC-G19	1000

晶体管固定弹片



晶体管固定弹片 TRANSISTOR CLAMP 五金弹片 电晶体固定弹片



- ◆ MATERIAL : SUS
- ◆ UNIT: mm

用途：晶体管固定弹片，也称五金弹片，可将功率晶体快速固定于散热片上，方便、耐高压。

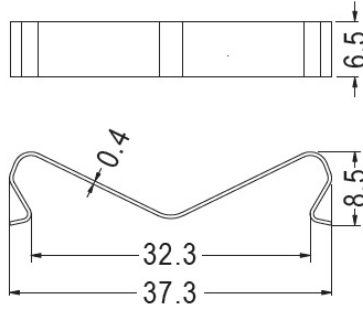

PART NO	PACKAGE
TRMC-G27	1000

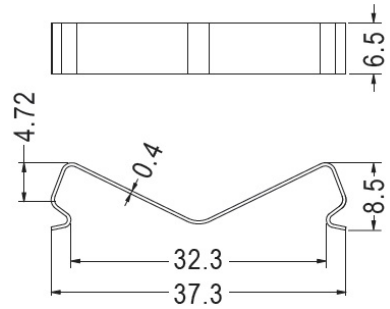

PART NO	PACKAGE
TRMC-G28	1000

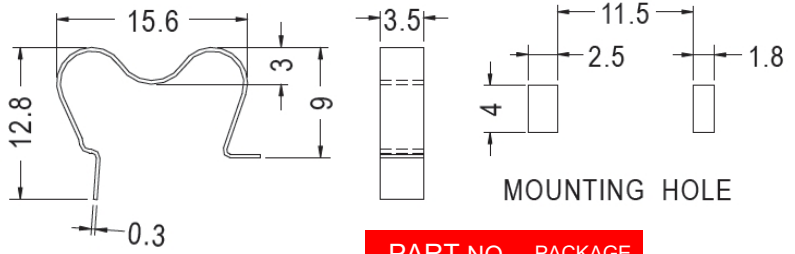

PART NO	PACKAGE
TO220-2	1000

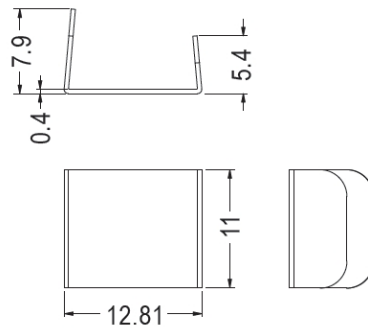

PART NO	PACKAGE
TRMC-G03	1000

晶体管固定弹片

# 晶体管夹 TRANSISTOR CLIP 电晶体夹

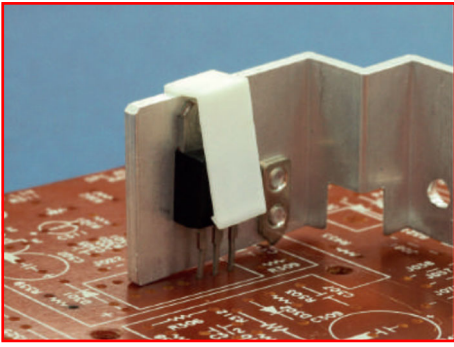

- ◆ MATERIAL : NYLON 66(UL)/PBT(UL) 用途: 晶体管夹, 用于功率晶体及散热片之固定, 可配合灌胶使用。
- ◆ FLAME CLASS : 94V-0
- ◆ COLOR : NATURAL
- ◆ UNIT: mm

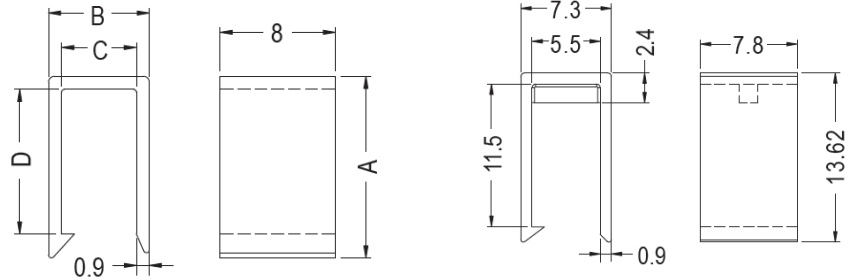

PART NO	A	B	C	D	PACKAGE
DTRCM-2	12.55	7.0	5.2	10.0	1000
DTRCM-3	12.6	7.5	5.7	10.0	1000
DTRCM-4	17.25	6.8	5.0	14.7	1000

PART NO	PACKAGE
DTRCM-1	1000

# 晶体管夹

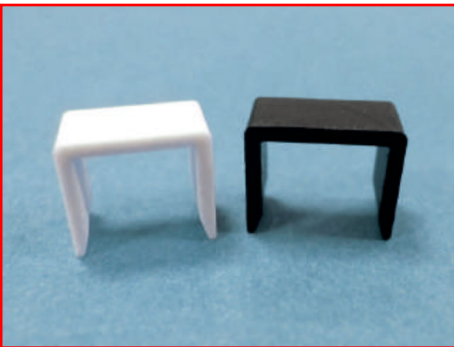

- ◆ MATERIAL : PBT(UL) 用途: 晶体管夹, 用于功率晶体及散热片之固定。
- ◆ FLAME CLASS : 94V-0
- ◆ COLOR : NATURAL/BLACK
- ◆ UNIT: mm

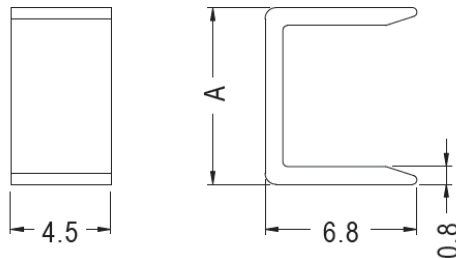

PART NO	A	PACKAGE
DTRCM-5	7.9	1000
DTRCM-6	8.6	1000

# 电子电脑塑胶五金零件目录

1.LED间隔柱

2.LED导光柱 LED导光盖 LED遮光罩

3.LED座 LED座套 红外线灯罩 光纤座

4.90°LED灯座 45°LED灯座

5. PC板间隔柱 PC板隔离柱

6. 塑料铜柱 尼龙柱 六角隔离柱 塑胶铜柱 铜柱 导光板隔离柱 圆体间隔柱 PC板固定定座 固定扣 电路板隔离柱 导电隔离柱

7. 排线固定座 自粘式配线固定座 排线固定夹 压线板 电线固定座 扭线固定座 扭式固定环 扎线固定座 电源线固定座 电源线固定座插头固定扣 天线固定座 T8灯管固定座 风扇束线座 光纤固定座

8. PC板端子 接线插片端子 PC板焊接端子 接地片 圆形连接片 弹片 测试针 探针 测试点 保险丝座 保险丝盖 插式电线连接头 闭端端子 弹簧螺纹端子 压线帽 端子台 快速接线夹 跳线

9. 仪表脚垫 插销式脚垫 螺丝固定脚垫 脚垫 抗震脚垫 磁铁脚垫 橡胶脚垫 自粘脚垫 银框脚垫 金框脚垫 橡胶垫圈 橡胶华司 橡胶垫片 硅胶脚垫

10. 塑料螺丝 塑胶螺丝 翼型塑料螺丝 塑料螺帽 塑料螺帽 蝶形螺母 止付螺丝 紧定螺钉 内牙螺丝 螺丝帽盖 手转螺丝 手拧螺丝 滚花螺丝 手转螺母 手拧螺母

11. PC板拉柄 PC板耳把 PC板导槽 电路板导轨 PCB导轨槽 直立式导槽 电路板导轨

12. 晶体管盖 电晶体盖 晶体管垫片 电晶体垫片 晶体管座 电晶体座 T-O3晶体管座 石英晶体垫片 垫圈 华司 垫片 TO-220晶体管座 光电晶体座 电晶体座 IR晶体座 霍尔晶体座 硅胶帽套 功率晶体导热硅片 功率晶体压板 电源固定压条 晶体管固定弹片 五金弹片 电晶体固定弹片 晶体管夹

# 电子电脑塑胶五金零件目录

13.电容器垫片 垫圈 华司 电容器座 电容器帽套 电容器固定座 电容器盖 电容器护套 压敏护套 硅胶帽套

14.热敏电阻座 电阻保护座 保护电阻器 可变电阻盖

15.陶瓷零件垫片 零件垫片 垫圈 华司 零件垫座 IC座 桥式整流座 跳线座 线圈座 滤波器垫片 绝缘柱 螺丝垫片 滚轮 PC板垫片 球击缓冲垫片 尼龙垫圈 尼龙弹簧垫片 散热陶瓷垫片

16.功率IC盖 桥式整流盖 保护盖 开关盖 硅胶盖 绝缘盖 电池盖 末端套管 软质端子保护套PC端子保护套 喇叭座 拉柄箱扣 线圈固定座 DRAM固定带 十字型插件式固定器 轨道固定器

17.孔塞 扣式孔塞 扣式塞头 DVI防尘盖 螺丝孔孔塞 螺丝塞头 螺纹孔塞

18.电源线扣 电线固定夹 护线环 橡胶圈 护线圈 开口式护线环 橡胶线环 硅胶线环 硅胶护线环 天线护线环 方型护线环 U型护线环 抗震护线环 防震线环 抗震线环用插销 抗震线环用螺丝 硬盘驱动器防震座 透气压力平衡固定头 透气平衡压力固定扣

19.把手 机箱把手 仪器门拉手 纸箱把手 纸箱配件 打包扣 外箱护脚垫 纸箱外箱扣

20.阻尼齿轮 阻尼器 缓冲齿轮

21.电线扎带 电线束线带 固定带 扎线 电源线收线带 珠型扎带 水管座 扎带座 扎带扣 吊勾粘扣带 绑线带

22.USB座护盖 USB端口保护盖 USB端口防尘盖 MICRO USB防尘盖 MINI USB座护盖USB Type-C防尘盖 USB防尘盖 RJ-45防尘盖 RJ-11防尘盖 RJ-12防尘盖 RJ-22防尘盖 电源插头防尘盖 电源插头保护座 电源插头防尘座 电源插头防尘盖 光纤连接器护盖 光纤连接器护套 光纤防尘盖 PC板金手指防尘盖 HDMI防尘盖 Mini数位端子防尘盖 汽车点烟器防尘盖BBU防尘盖 DVI防尘盖 连接器盖 SIM Card Cap防尘盖 SD防尘盖 KVM防尘盖 CF防尘盖 防尘盖 端子盖 S端子盖 平衡端子盖 BNC绝缘座 SATA防尘盖 ESATA护盖 DP端子防尘盖 Mini D.P数位端子防尘盖 D.Type防尘盖 VGA防尘盖 IDE Connector防尘盖 PC端子防尘盖 端子防尘盖 1394端子防尘盖 零件盖 电源盖 机板电源保护盖 连接器座 PCMIC卡保护盖 面板 DDR防尘盖 D-Sub保护盖 高压防尘盖 SD保护盖 Micoro SD卡保护盖 SIM卡保护盖 防水帽盖 帽盖连接带 防水圈 电脑风扇防护盖 电脑风扇防尘座 电脑风扇框护垫 电脑风扇支架 开关遮板 光纤晶体座



# 电子电脑塑胶五金零件目录

23.插销 铆钉 尼龙铆钉 螺丝铆钉 散热片铆钉 塑料铆钉 电脑风扇铆钉 散热片扣件 弹簧铆钉 螺丝固定座 膨胀螺栓 墙塞 无帽鱼型膨胀管 墙面固定座 石膏板固定座

24.固定扣 门扣开关 机器门扣开关 弹簧固定座 旋转型门扣 门扣碰珠 磁铁门扣

55.工具 线扣工具 进口束线枪 旗型端子工具 国产束线枪 非绝缘端子工具 绝缘端子工具



# 电子电脑塑胶五金零件目录



1.LED间隔柱



2.LED导光柱



3.LED座



4.90°LED灯座



5.PC板间隔柱



6.塑料铜柱



7.排线固定座



8.PC板端子



9.仪表脚垫



10.塑料螺丝



11.PC板拉柄导槽



12.晶体管盖

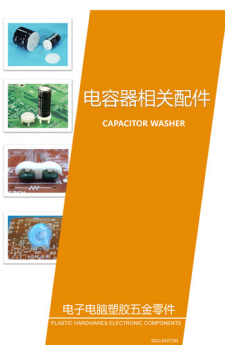

13.电容器垫片



14.热敏电阻座



15.陶瓷零件垫片



16.功率IC盖



# 电子电脑塑胶五金零件目录



17.孔塞



18.电源线扣



19.机箱把手



20.阻尼齿轮



21.电线扎带



22.USB座护盖



23.尼龙铆钉



24.门扣开关



55.工具



选型手册总目录

本公司保留因质量改进、后续开发或生产要求引起的设计更改权力。本产品目录为元件的详细说明，不能做担保依据。使用者有义务审核该元件是否符合应用范围的规定。



微信



QQ

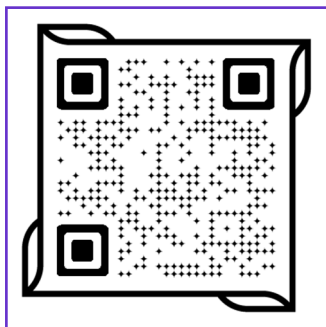

网站

**南京诺金电气有限公司**  
Nanjing Nowking Electric Co., Ltd

- ◆ Tel: 025-85422485 85436028 85437901
- ◆ Wechat/Mobile :13770725488
- ◆ QQ:260678075
- ◆ E-mail: nk@nowking.com
- ◆ Http://www.nowking.com
- ◆ Http://www.kyphe.com