

南京诺金电气有限公司

Nanjing Nowking Electric Co., Ltd

零件垫座样本

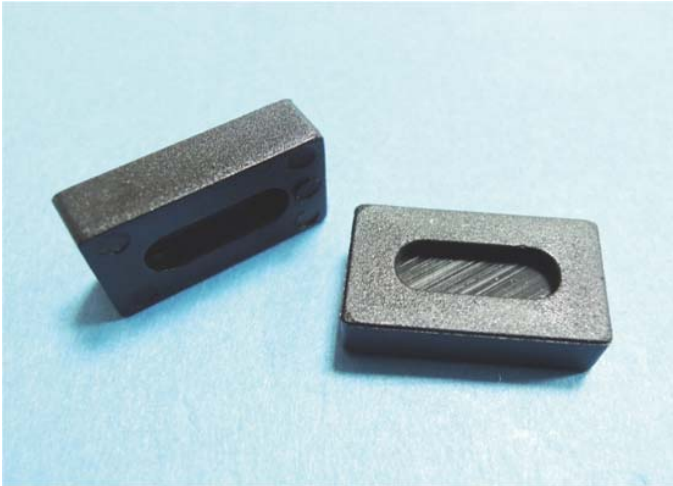

产品名称：零件垫座

规格型号：PAHO-001

- ◆ MATERIAL: NYLON 66(UL)
- ◆ FLAME CLASS: 94V-2, 94V-0
- ◆ COLOR: BLACK, NATURAL
- ◆ UNIT: mm

用途：用于零件之垫高。

PAHO-001 结构图

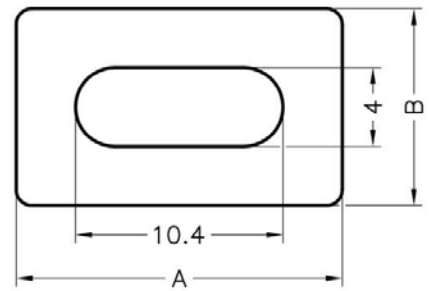
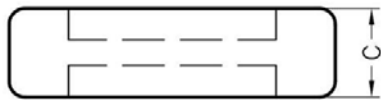

PART NO	A	B	C	PACKAGE
PAHO-001	16.5	10.0	4.5	1000

南京诺金电气有限公司

Nanjing Nowking Electric Co., Ltd

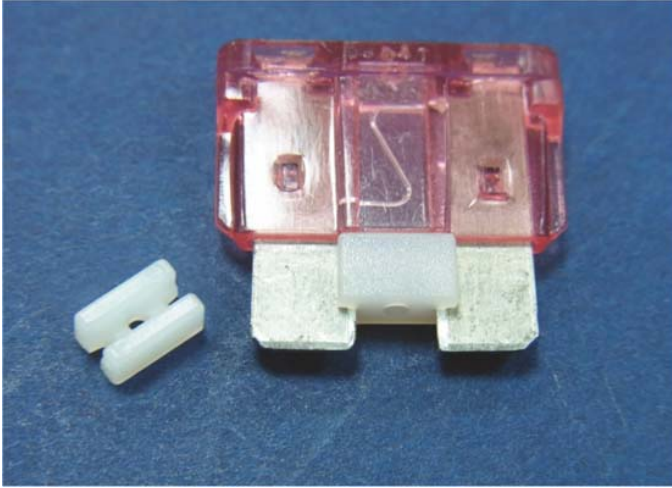

产品名称：零件垫座

规格型号：PAHO-002

- ◆ MATERIAL: NYLON 66(UL)
- ◆ FLAME CLASS: 94V-2, 94V-0
- ◆ COLOR: BLACK, NATURAL
- ◆ UNIT: mm

用途：用于汽车保险丝之间隔、垫高作用。

PAHO-002 结构图

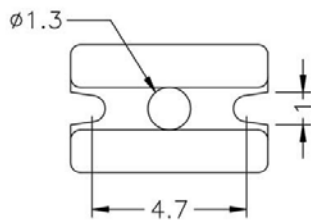
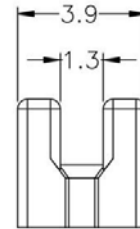
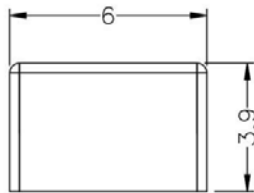

	PART NO	PACKAGE
	PAHO-002	2000

南京诺金电气有限公司

Nanjing Nowking Electric Co., Ltd

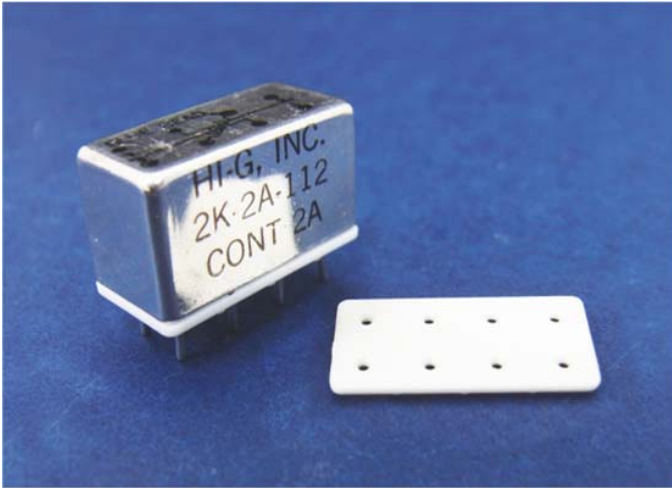

产品名称：零件垫座

规格型号：PAHO-003

- ◆ MATERIAL: PBT(UL)
- ◆ FLAME CLASS: 94V-0
- ◆ COLOR: NATURAL
- ◆ UNIT: mm

用途：用于继电器之垫高与保护。

PAHO-003 结构图

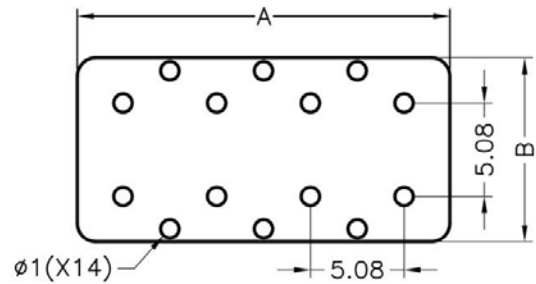
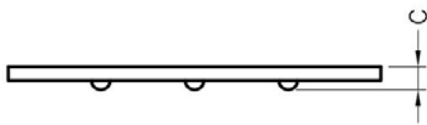

PART NO	A	B	C	PACKAGE
PAHO-003	20.2	10.0	1.25	500

南京诺金电气有限公司

Nanjing Nowking Electric Co., Ltd

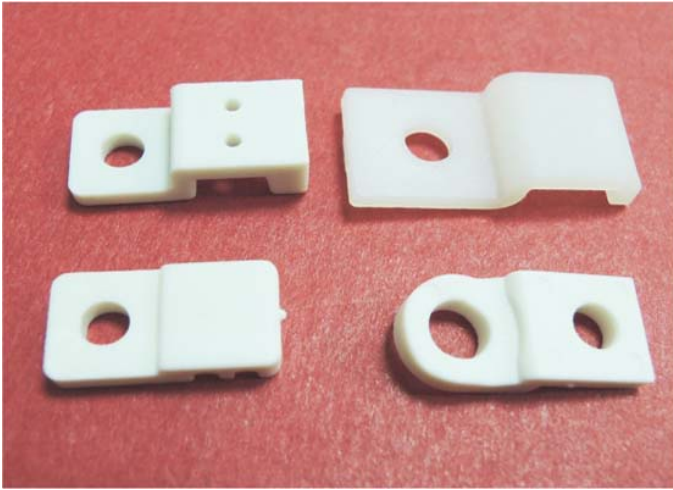

产品名称：零件底座

规格型号：PAHO-004

- ◆MATERIAL:PBT(UL)
- ◆FLAME CLASS:94V-0
- ◆COLOR:WHITE,NATURAL
- ◆UNIT: mm

用途：用于热敏电阻接脚之固定与保护。

MATERIAL 1 为耐高温

PAHO-004 结构图

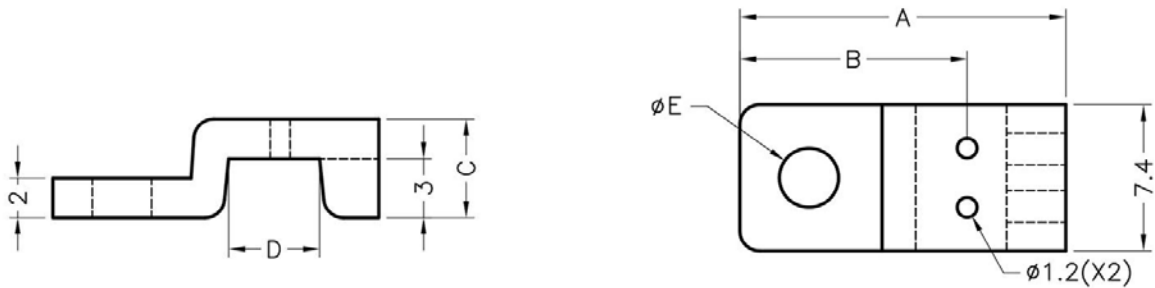

PART NO	A	B	C	D	E	PACKAGE
PAHO-004	16.5	11.5	5.0	4.7	3.2	1000

南京诺金电气有限公司

Nanjing Nowking Electric Co., Ltd

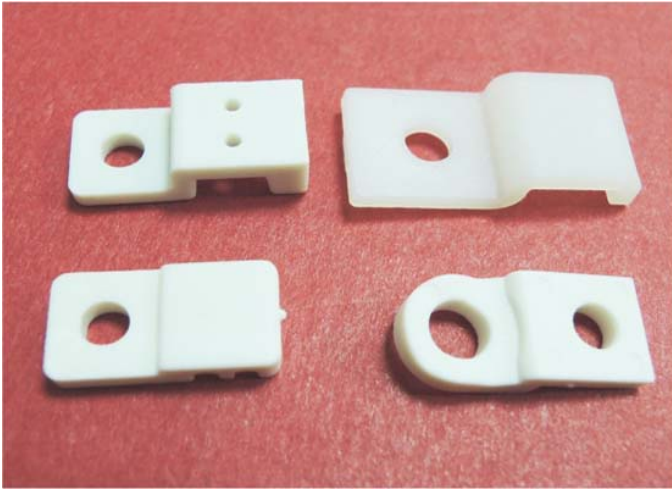

产品名称：零件垫座

规格型号：PAHO-005

- ◆ MATERIAL: PBT(UL)
- ◆ FLAME CLASS: 94V-0
- ◆ COLOR: WHITE, NATURAL
- ◆ UNIT: mm

用途：用于热敏电阻接脚之固定与保护。

MATERIAL 1 为耐高温

PAHO-005 结构图

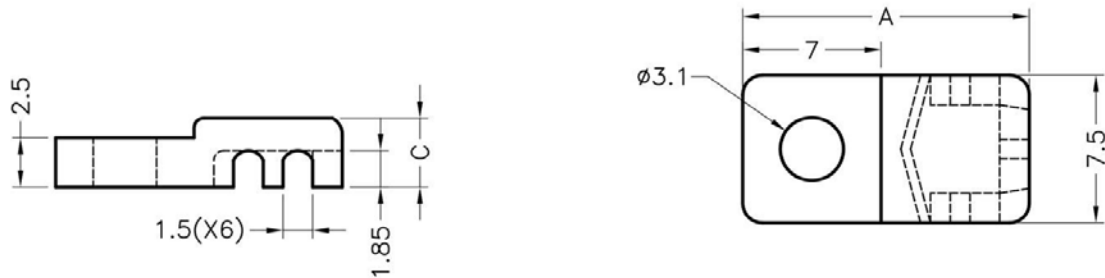

PART NO	A	C	PACKAGE
PAHO-005	14.5	3.5	1000

南京诺金电气有限公司

Nanjing Nowking Electric Co., Ltd

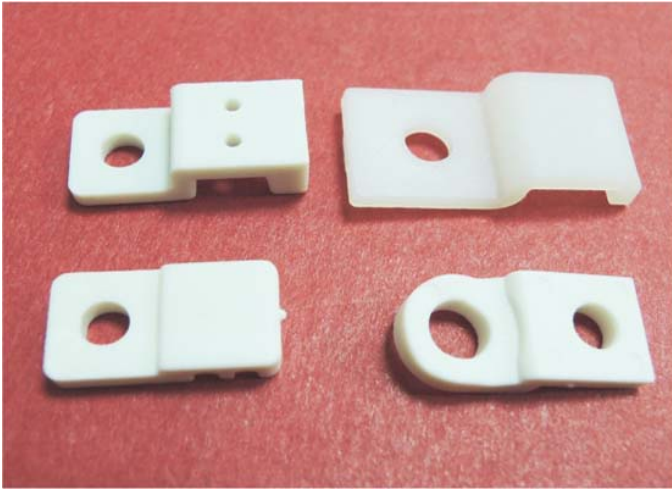

产品名称：零件垫座

规格型号：PAHO-006

- ◆ MATERIAL: PBT(UL)
- ◆ FLAME CLASS: 94V-0
- ◆ COLOR: WHITE, NATURAL
- ◆ UNIT: mm

用途：用于热敏电阻接脚之固定与保护。

MATERIAL 1 为耐高温

PAHO-006 结构图

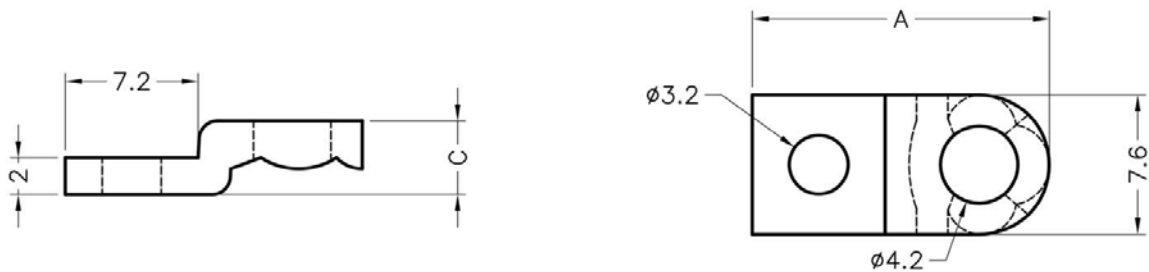

PART NO	A	C	PACKAGE
PAHO-006	16.1	4.0	1000

南京诺金电气有限公司

Nanjing Nowking Electric Co., Ltd

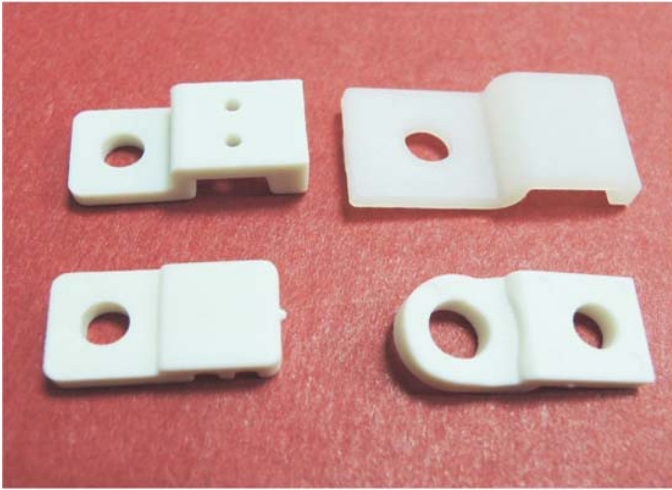

产品名称：零件垫座

规格型号：PAHO-007

- ◆ MATERIAL: PBT(UL)
- ◆ FLAME CLASS: 94V-0
- ◆ COLOR: WHITE, NATURAL
- ◆ UNIT: mm

用途：用于热敏电阻接脚之固定与保护。

MATERIAL 1 为耐高温

PAHO-007 结构图

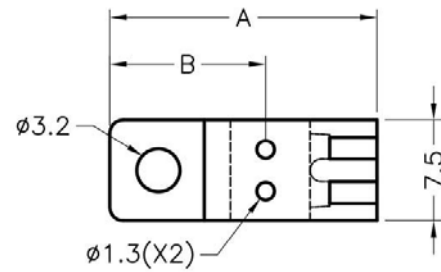
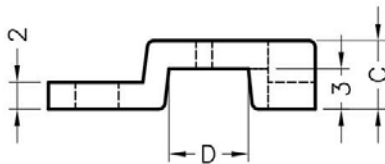

PART NO	A	B	C	D	PACKAGE
PAHO-007	19.8	11.55	5.1	5.9	1000

南京诺金电气有限公司

Nanjing Nowking Electric Co., Ltd

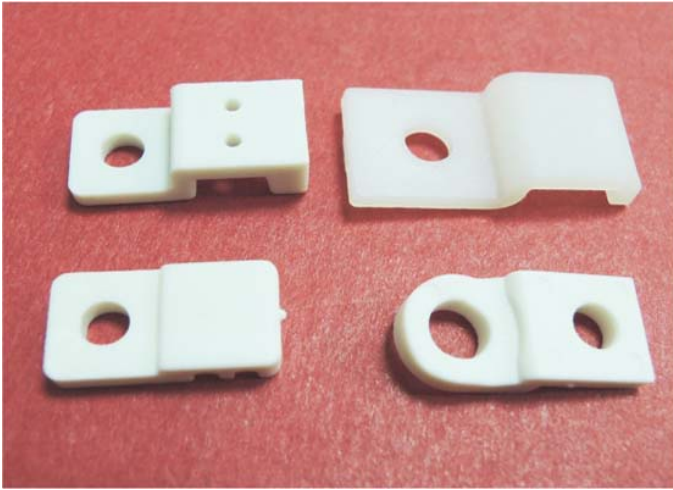

产品名称：零件垫座

规格型号：PAHO-008

- ◆ MATERIAL: PBT(UL)
- ◆ FLAME CLASS: 94V-0
- ◆ COLOR: WHITE, NATURAL
- ◆ UNIT: mm

用途：用于热敏电阻接脚之固定与保护。

MATERIAL 1 为耐高温

PAHO-008 结构图

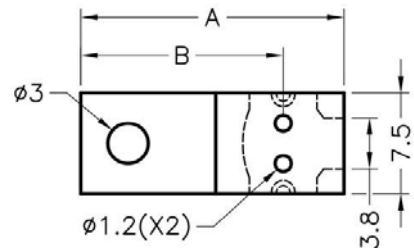
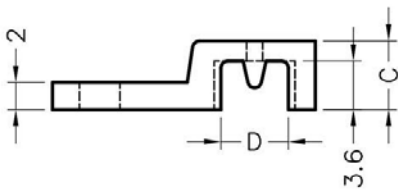

PART NO	A	B	C	D	PACKAGE
PAHO-008	19.5	15.0	5.1	5.0	1000

南京诺金电气有限公司

Nanjing Nowking Electric Co., Ltd

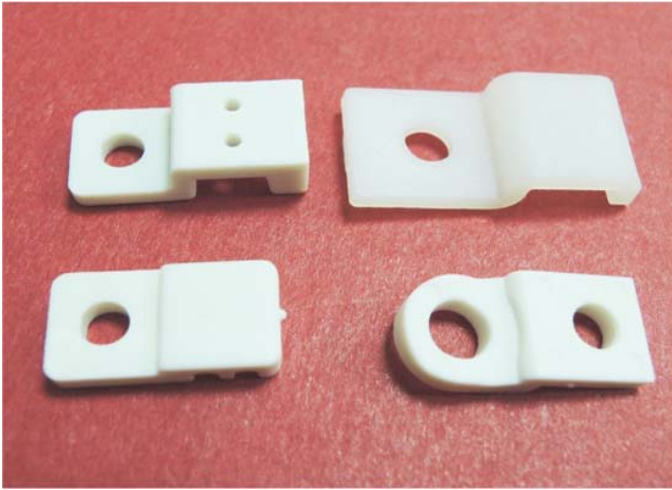

产品名称：零件垫座

规格型号：PAHO-009

- ◆ MATERIAL: PBT(UL)
- ◆ FLAME CLASS: 94V-0
- ◆ COLOR: WHITE, NATURAL
- ◆ UNIT: mm

用途：用于热敏电阻接脚之固定与保护。

MATERIAL 1 为耐高温

PAHO-009 结构图

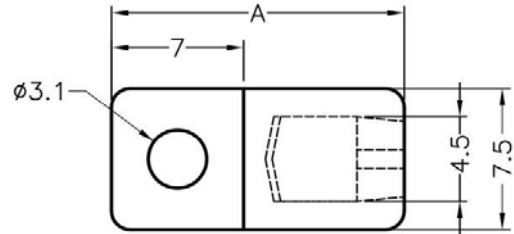
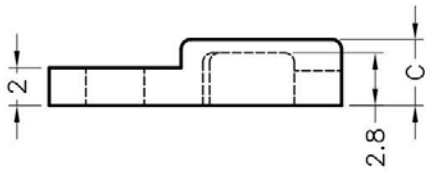

PART NO	A	C	PACKAGE
PAHO-009	15.5	3.5	1000

南京诺金电气有限公司

Nanjing Nowking Electric Co., Ltd

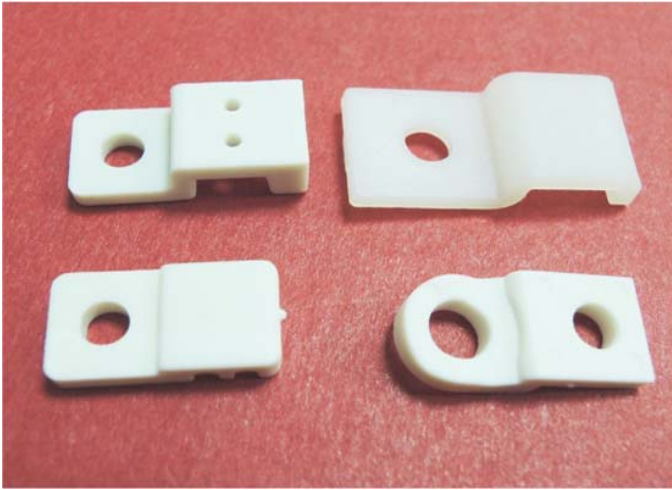

产品名称：零件垫座

规格型号：PAHO-010

- ◆ MATERIAL: PBT(UL)
- ◆ FLAME CLASS: 94V-0
- ◆ COLOR: WHITE, NATURAL
- ◆ UNIT: mm

用途：用于热敏电阻接脚之固定与保护。

MATERIAL 1 为耐高温

PAHO-010 结构图

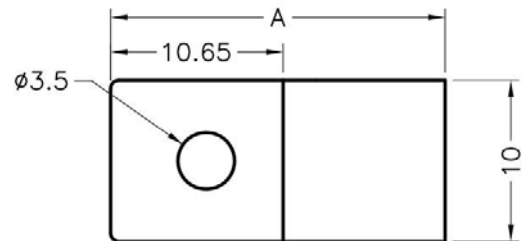
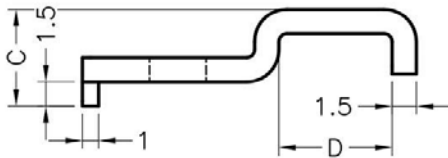

PART NO	A	C	D	PACKAGE
PAHO-010	20.65	6.0	7.0	1000

南京诺金电气有限公司

Nanjing Nowking Electric Co., Ltd

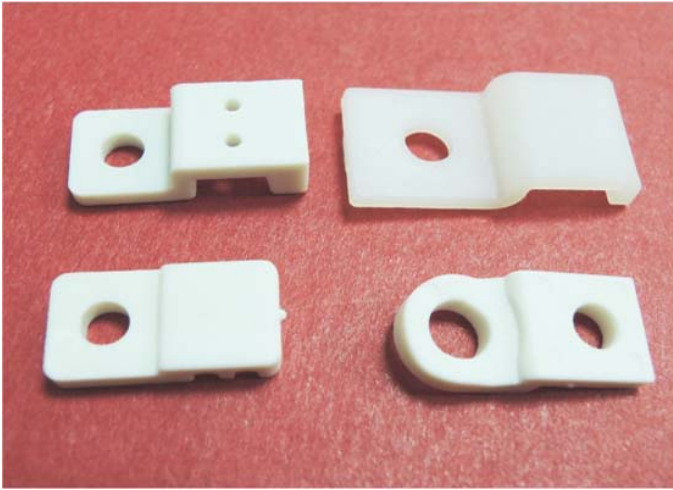

产品名称：零件垫座

规格型号：PAHO-011

- ◆ MATERIAL: PBT(UL)
- ◆ FLAME CLASS: 94V-0
- ◆ COLOR: WHITE, NATURAL
- ◆ UNIT: mm

用途：用于热敏电阻接脚之固定与保护。

MATERIAL 1 为耐高温

PAHO-011 结构图

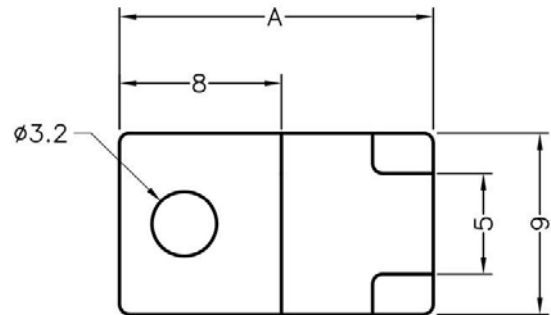
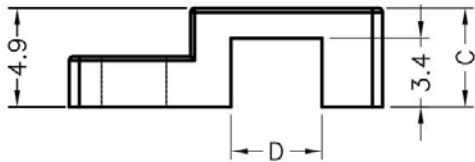

PART NO	A	C	D	PACKAGE
PAHO-011	15.5	4.9	4.5	1000

南京诺金电气有限公司

Nanjing Nowking Electric Co., Ltd

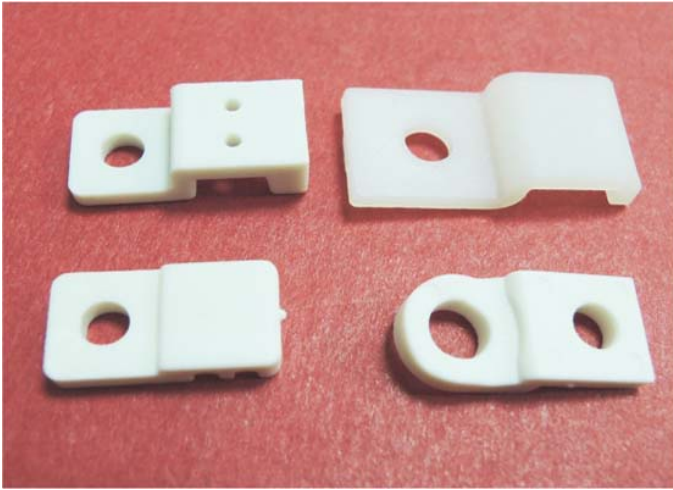

产品名称：零件垫座

规格型号：PAHO-012

- ◆ MATERIAL: PBT(UL)
- ◆ FLAME CLASS: 94V-0
- ◆ COLOR: WHITE, NATURAL
- ◆ UNIT: mm

用途：用于热敏电阻接脚之固定与保护。

MATERIAL 1 为耐高温

PAHO-012 结构图

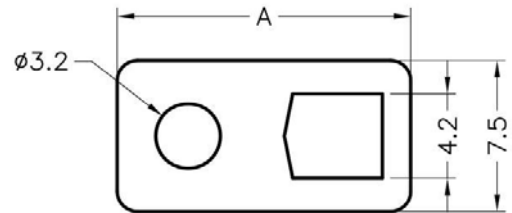
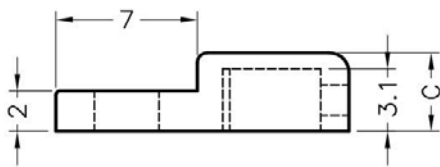

PART NO	A	C	-	PACKAGE
PAHO-012	14.5	3.9	-	1000

南京诺金电气有限公司

Nanjing Nowking Electric Co., Ltd



产品名称：零件垫座

规格型号：PAHO-013

◆ MATERIAL:PC(UL)

◆ FLAME CLASS:94V-0,94V-2

◆ COLOR:NATURAL

◆ UNIT: mm

用途：用于热敏电阻接脚之固定与保护。

PAHO-013 结构图

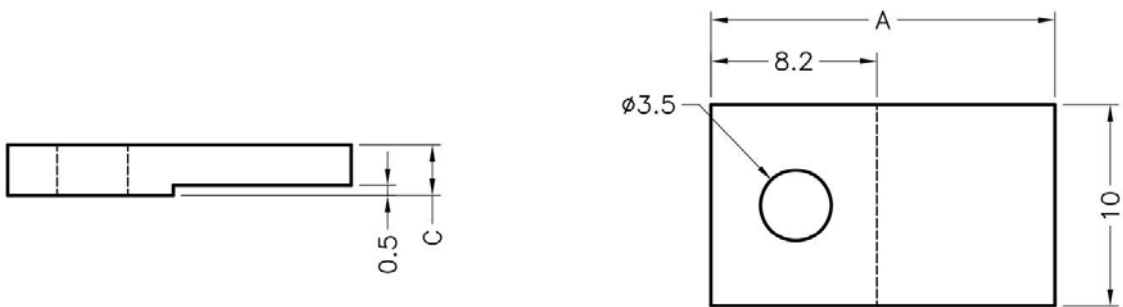

PART NO	A	C	-	PACKAGE
PAHO-013	17.0	2.5	-	1000

南京诺金电气有限公司

Nanjing Nowking Electric Co., Ltd

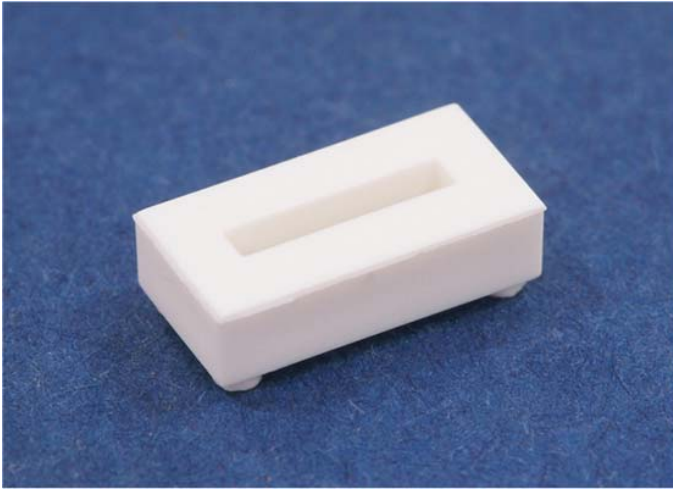

产品名称：零件垫座

规格型号：PAHO-014

- ◆ MATERIAL: NYLON 66(UL)
- ◆ FLAME CLASS: 94V-0, 94V-2
- ◆ COLOR: NATURAL, BLACK
- ◆ UNIT: mm

用途：用于零件垫高。

可使用同等材质

PAHO-014 结构图

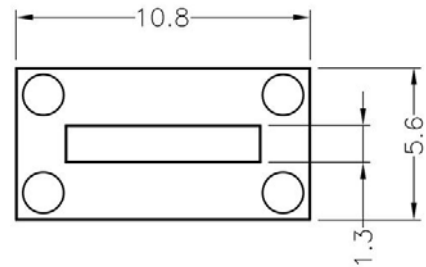
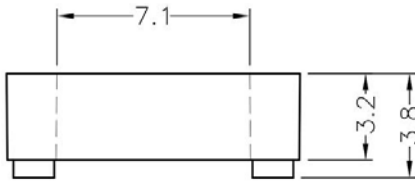

	PART NO	PACKAGE
	PAHO-014	1000

南京诺金电气有限公司

Nanjing Nowking Electric Co., Ltd

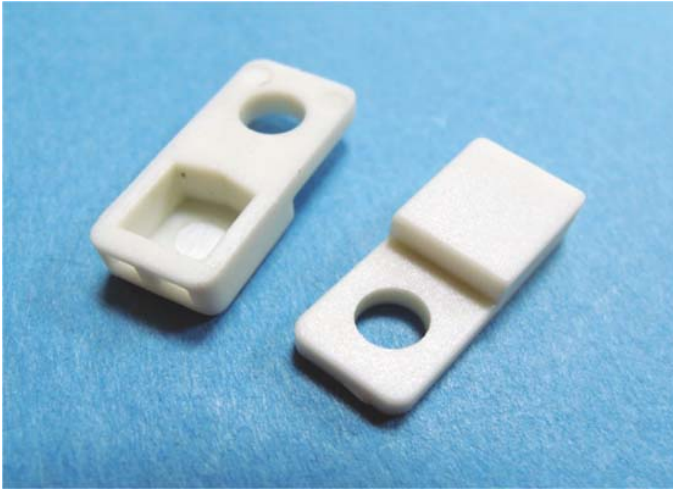

产品名称：零件垫座

规格型号：PAHO-015

- ◆ MATERIAL: PBT(UL)
- ◆ FLAME CLASS: 94V-0
- ◆ COLOR: NATURAL
- ◆ UNIT: mm

用途：用于热敏电阻接脚之固定与保护。

PAHO-015 结构图

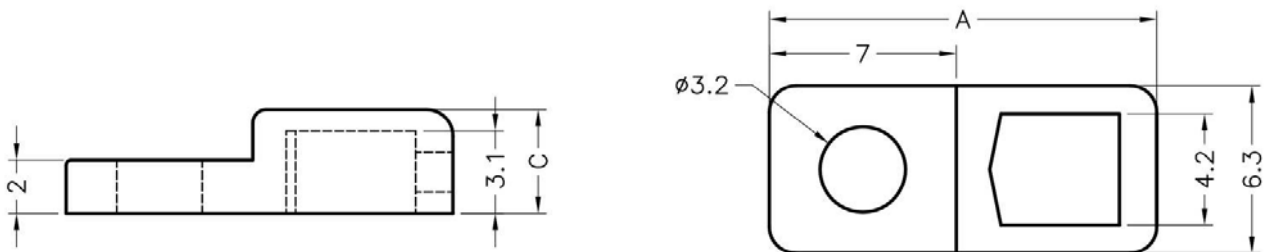

	PART NO	A	C	PACKAGE
	PAHO-015	14.5	3.9	1000

南京诺金电气有限公司

Nanjing Nowking Electric Co., Ltd

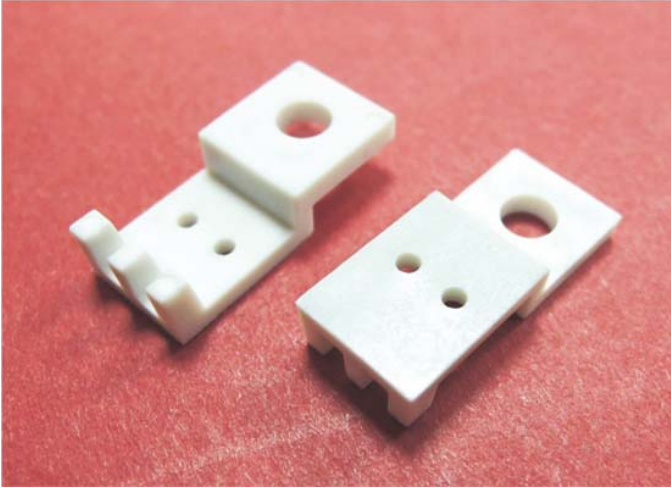

产品名称：零件垫座

规格型号：PAHO-016

◆ MATERIAL:P(UL)

◆ FLAME CLASS:94V-0,

◆ COLOR:NATURAL,BLACK

◆ UNIT: mm

用途：用于热敏电阻接脚之固定与保护。BT
MATERIAL 1 为耐高温

PAHO-016 结构图

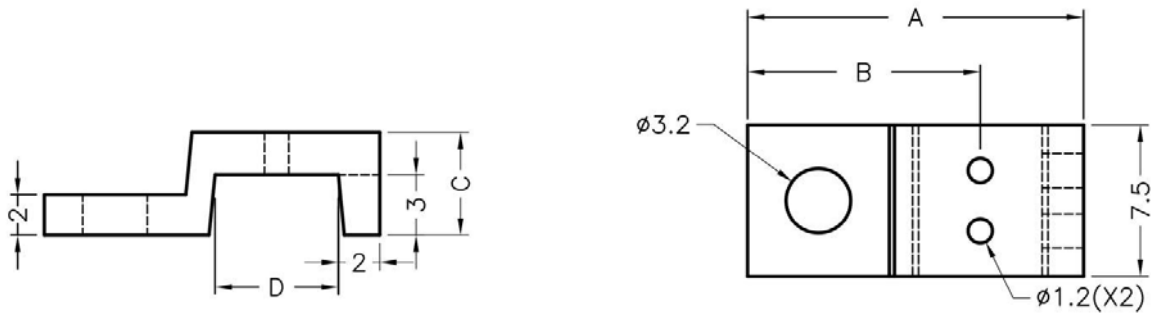

PART NO	A	B	C	D	PACKAGE
PAHO-016	16.6	11.5	5.1	6.1	1000

南京诺金电气有限公司

Nanjing Nowking Electric Co., Ltd

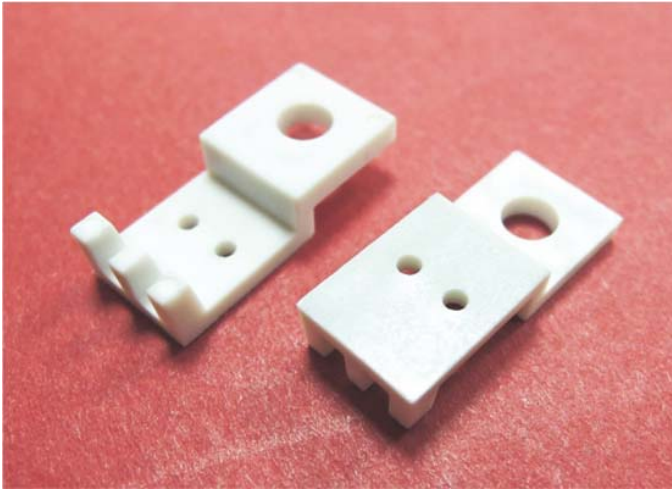

产品名称：零件垫座

规格型号：PAHO-017

- ◆ MATERIAL: PBT(UL)
- ◆ FLAME CLASS: 94V-0,
- ◆ COLOR: NATURAL, BLACK
- ◆ UNIT: mm

用途：用于热敏电阻接脚之固定与保护。

MATERIAL 1 为耐高温

PAHO-017 结构图

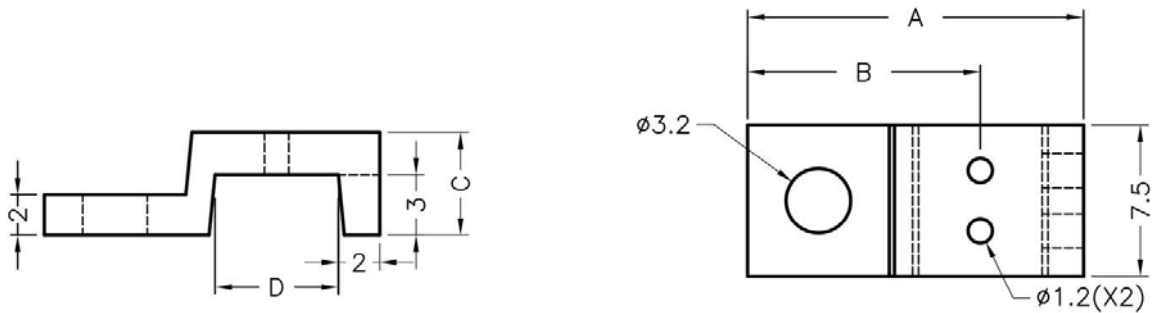

PART NO	A	B	C	D	PACKAGE
PAHO-017	17.15	11.8	4.6	6.7	1000

南京诺金电气有限公司

Nanjing Nowking Electric Co., Ltd

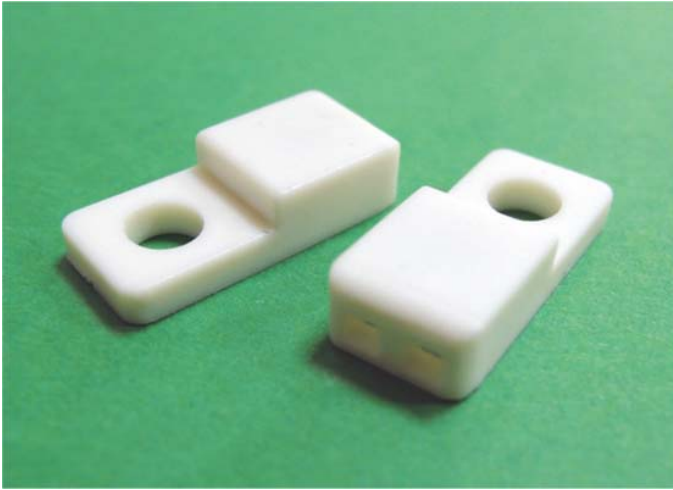

产品名称：零件垫座

规格型号：PAHO-018

- ◆ MATERIAL: PBT(UL)
- ◆ FLAME CLASS: 94V-0
- ◆ COLOR: NATURAL
- ◆ UNIT: mm

用途：用于热敏电阻接脚之固定与保护。

PAHO-018 结构图

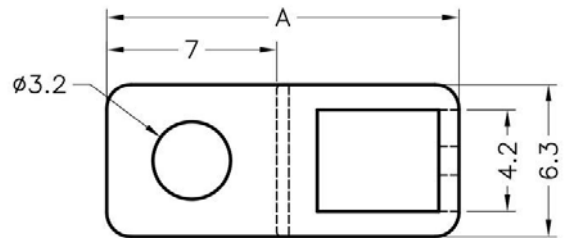
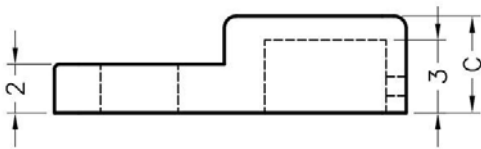

	PART NO	A	C	PACKAGE
	PAHO-018	14.5	4.0	1000

南京诺金电气有限公司

Nanjing Nowking Electric Co., Ltd

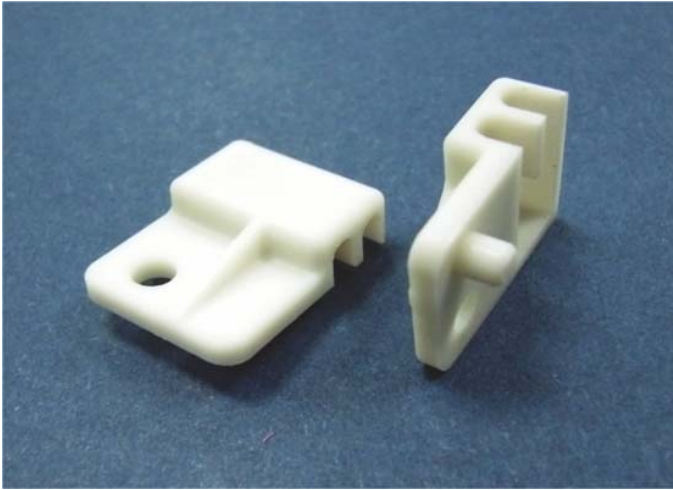

产品名称：零件垫座

规格型号：PAHO-019

- ◆ MATERIAL: NYLON 66(UL)
- ◆ FLAME CLASS: 94V-0, 94V-2
- ◆ COLOR: NATURAL, BLACK
- ◆ UNIT: mm

用途：用于热敏电阻接脚之固定与保护。

PAHO-019 结构图

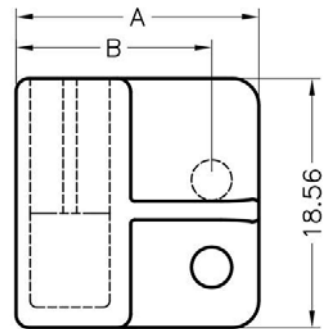
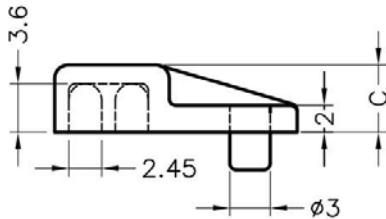

PART NO	A	B	C	PACKAGE
PAHO-019	18.0	14.5	5.0	1000

南京诺金电气有限公司

Nanjing Nowking Electric Co., Ltd



产品名称：零件垫座

规格型号：PAHO-020

- ◆ MATERIAL: PBT(UL)
- ◆ FLAME CLASS: 94V-0
- ◆ COLOR: NATURAL
- ◆ UNIT: mm

用途：用于热敏电阻接脚之固定与保护。

PAHO-020 结构图

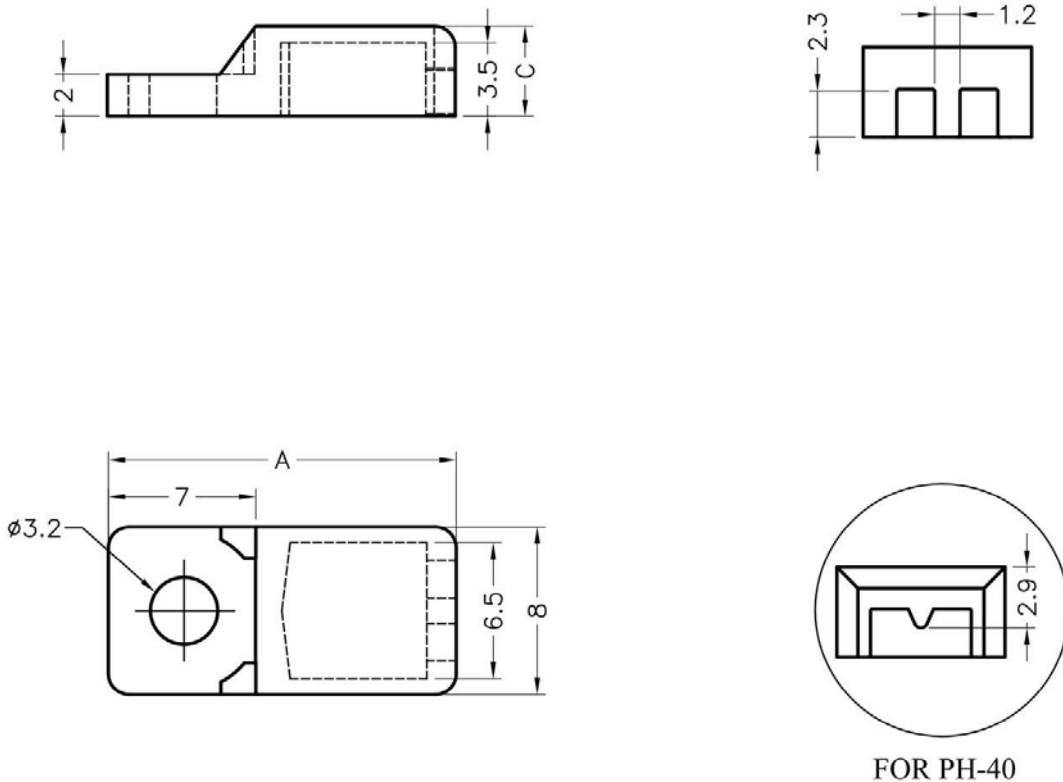

PART NO	A	C	PACKAGE
PAHO-020	16.55	4.3	1000

南京诺金电气有限公司

Nanjing Nowking Electric Co., Ltd



产品名称：零件垫座

规格型号：PAHO-021

- ◆ MATERIAL: PBT(UL)
- ◆ FLAME CLASS: 94V-0
- ◆ COLOR: NATURAL
- ◆ UNIT: mm

用途：用于热敏电阻接脚之固定与保护。

PAHO-021 结构图

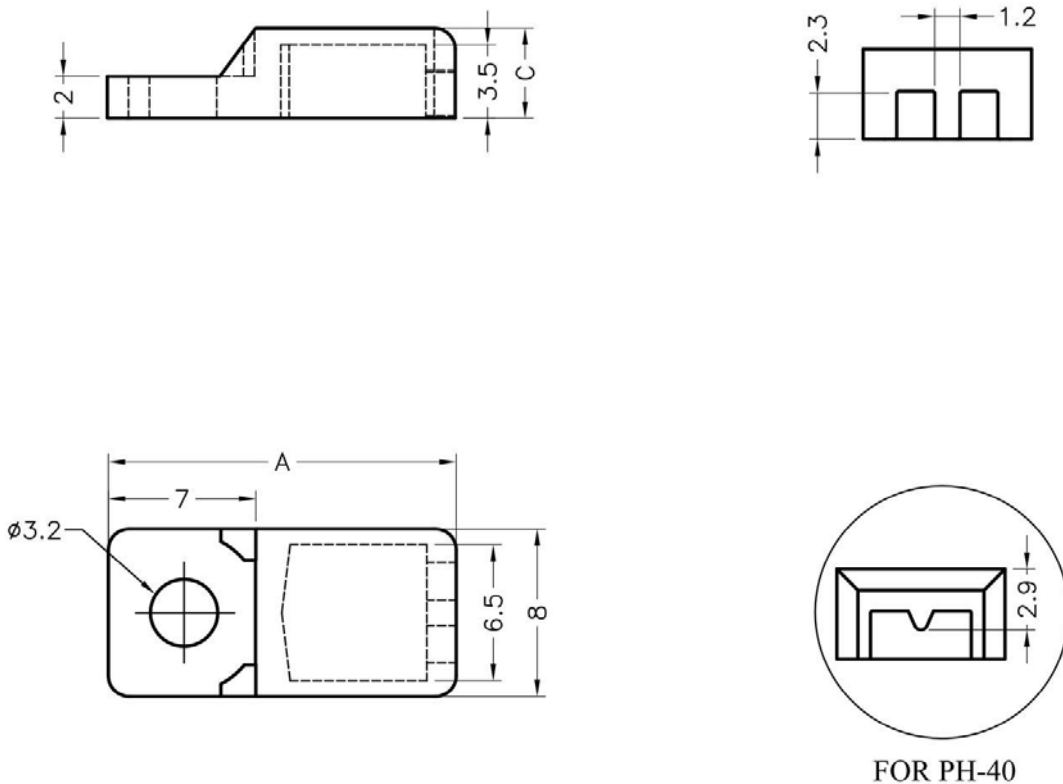

PART NO	A	C	PACKAGE
PAHO-021	16.55	4.3	1000

南京诺金电气有限公司

Nanjing Nowking Electric Co., Ltd

产品名称：零件垫座

规格型号：PAHO-022

◆ MATERIAL: NYLON 66(UL), PBT(UL)

◆ FLAME CLASS: 94V-0, 94V-2

◆ COLOR: NATURAL, BLACK

◆ UNIT: mm

用途：用于热敏电阻接脚之固定与保护。

MATERIAL 1 为耐高温



PAHO-022 结构图

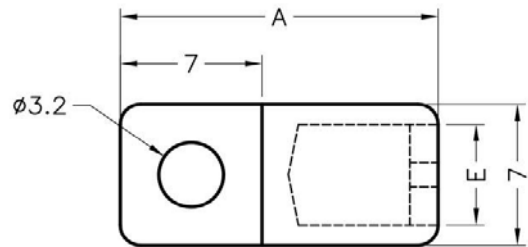
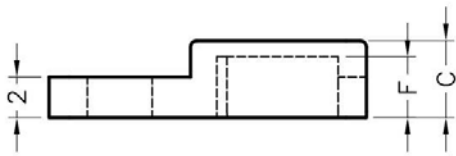

PART NO	A	C	E	F	PACKAGE
PAHO-022	15.7	3.8	5.0	3.0	1000

南京诺金电气有限公司

Nanjing Nowking Electric Co., Ltd

产品名称：零件垫座

规格型号：PAHO-023

◆ MATERIAL: NYLON 66(UL), PBT(UL)

◆ FLAME CLASS: 94V-0, 94V-2

◆ COLOR: NATURAL, BLACK

◆ UNIT: mm

用途：用于热敏电阻接脚之固定与保护。

MATERIAL 1 为耐高温



PAHO-023 结构图

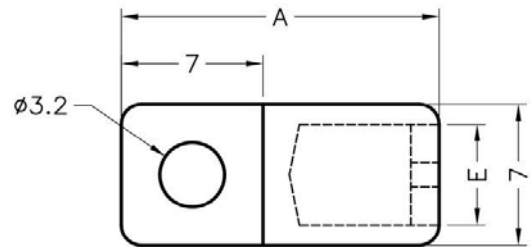
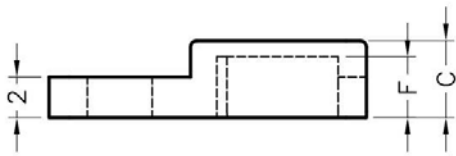

PART NO	A	C	E	F	PACKAGE
PAHO-023	15.7	3.8	5.4	3.4	1000

南京诺金电气有限公司

Nanjing Nowking Electric Co., Ltd



产品名称：零件垫座

规格型号：PAHO-024

◆ MATERIAL: PBT(UL), NYLON 66(UL)

◆ FLAME CLASS: 94V-0

◆ COLOR: NATURAL, BLACK

◆ UNIT: mm

用途：用于热敏电阻接脚之固定与保护。

PAHO-024 结构图

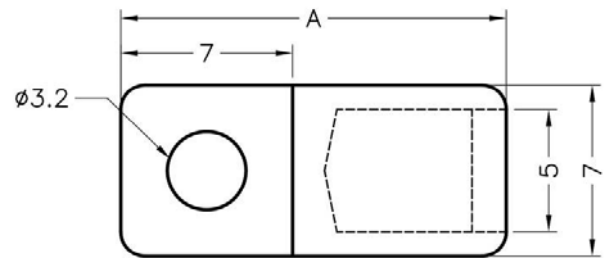
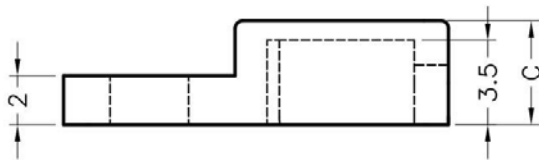

	PART NO	A	C	PACKAGE
	PAHO-024	15.70	4.3	1000

南京诺金电气有限公司

Nanjing Nowking Electric Co., Ltd



产品名称：零件垫座

规格型号：PAHO-025

◆ MATERIAL: PBT(UL), NYLON 66(UL)

◆ FLAME CLASS: 94V-0

◆ COLOR: NATURAL, BLACK

◆ UNIT: mm

用途：用于热敏电阻接脚之固定与保护。

PAHO-025 结构图

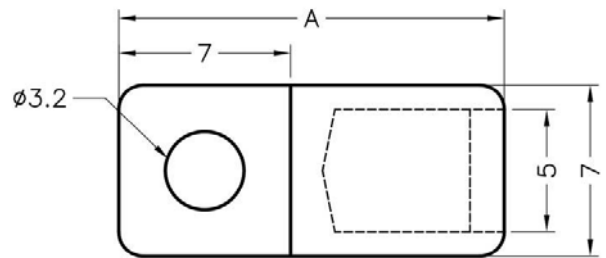
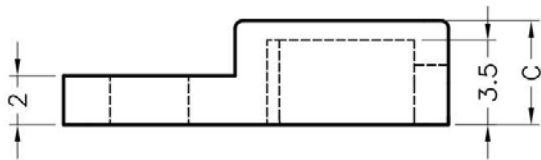

	PART NO	A	C	PACKAGE
	PAHO-025	15.70	4.3	1000

南京诺金电气有限公司

Nanjing Nowking Electric Co., Ltd

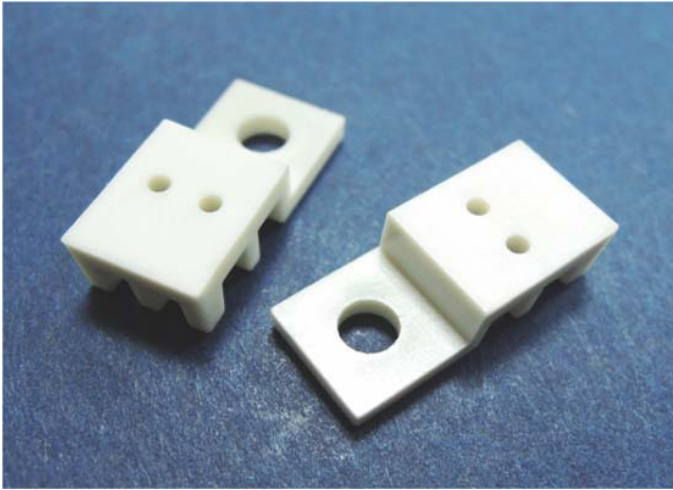

产品名称：零件垫座

规格型号：PAHO-026

- ◆ MATERIAL: PBT(UL)
- ◆ FLAME CLASS: 94V-0
- ◆ COLOR: NATURAL
- ◆ UNIT: mm

用途：用于热敏电阻接脚之固定与保护。

PAHO-026 结构图

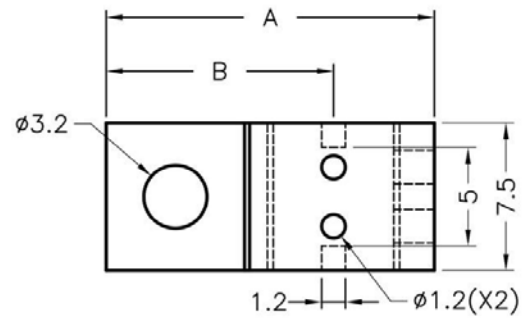
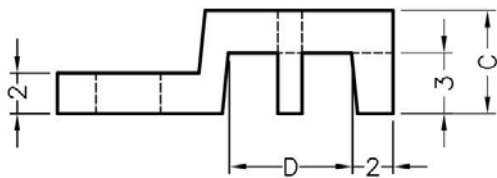

PART NO	A	B	C	D	PACKAGE
PAHO-026	16.6	11.5	5.1	6.1	1000

南京诺金电气有限公司

Nanjing Nowking Electric Co., Ltd

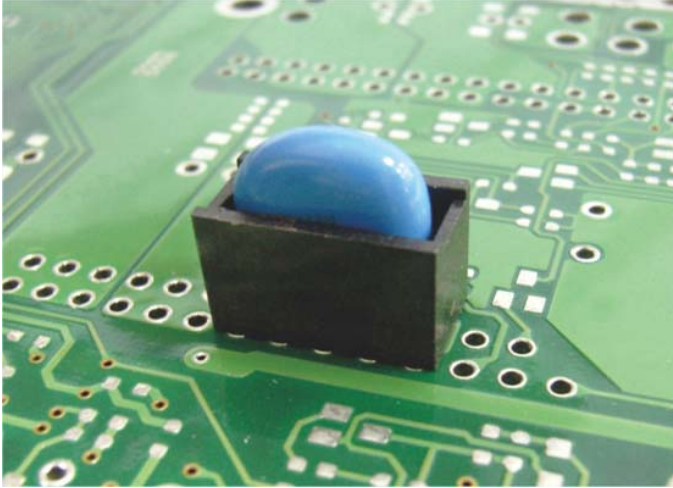

产品名称：零件垫座

规格型号：PAHO-027

- ◆ MATERIAL:PPS(UL)
- ◆ FLAME CLASS:94V-0
- ◆ COLOR:BLACK
- ◆ UNIT: mm

用途：用于零件垫座。

PAHO-027 结构图

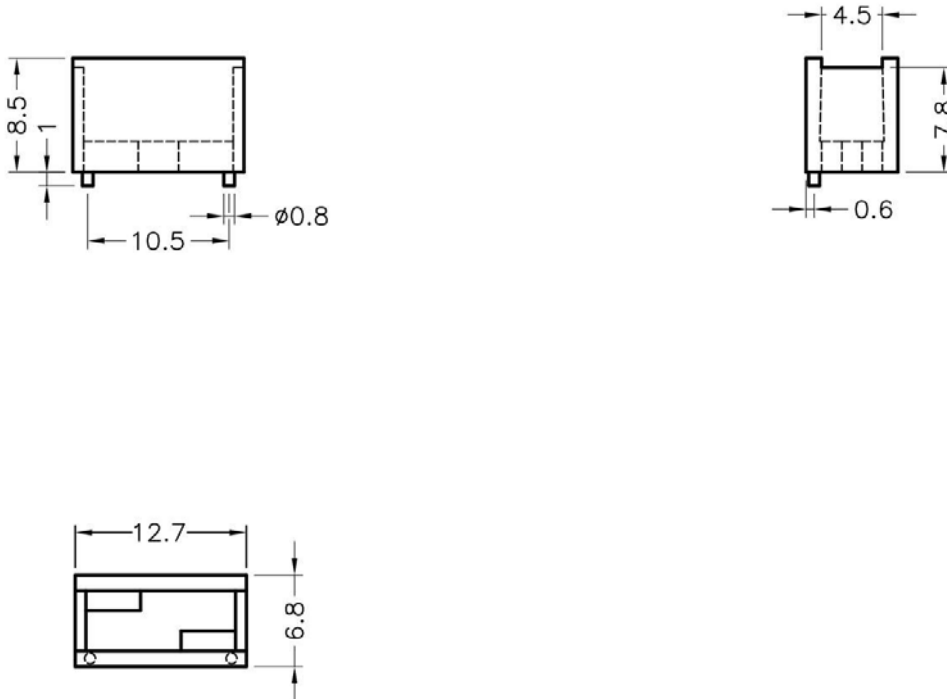

	PART NO	PACKAGE
	PAHO-027	1000

南京诺金电气有限公司

Nanjing Nowking Electric Co., Ltd



产品名称：零件垫座

规格型号：PAHO-028

- ◆ MATERIAL: PBT(UL)
- ◆ FLAME CLASS: 94V-0
- ◆ COLOR: NATURAL
- ◆ UNIT: mm

用途：用于热敏电阻接脚之固定与保护。

PAHO-028 结构图

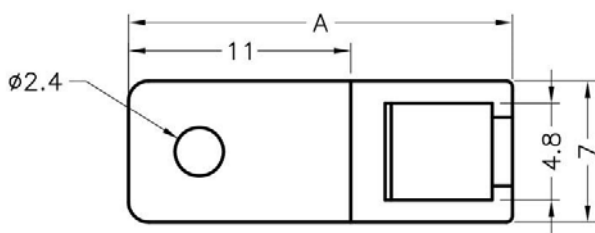
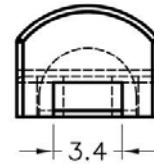
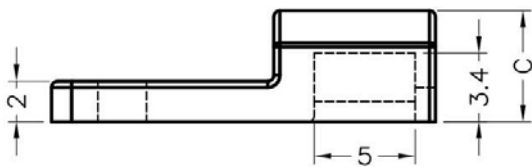

	PART NO	A	C	E	PACKAGE
	PAHO-028	19.0	5.5	2.4	1000

南京诺金电气有限公司

Nanjing Nowking Electric Co., Ltd

产品名称：零件垫座

规格型号：PAHO-029

◆ MATERIAL: PC(UL)

◆ FLAME CLASS:94V-0

◆ COLOR:BLACK

◆ UNIT: mm

用途：用于热敏电阻接脚之固定与保护。



PAHO-029 结构图

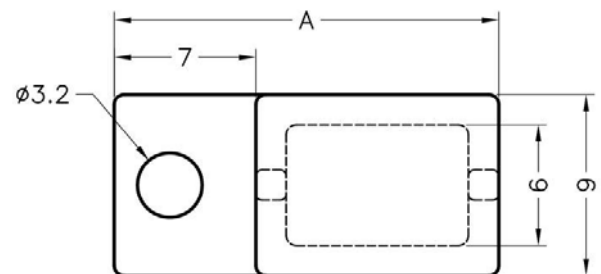
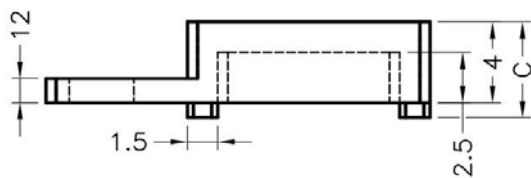

	PART NO	A	C	PACKAGE
	PAHO-029	19.0	4.75	1000

南京诺金电气有限公司

Nanjing Nowking Electric Co., Ltd



产品名称：零件垫座

规格型号：PAHO-030

◆ MATERIAL: NYLON 66(UL)

◆ FLAME CLASS: 94V-0, 94V-2

◆ COLOR: BLACK, NATURAL

◆ UNIT: mm

用途：用于热敏电阻接脚之固定与保护。

PAHO-030 结构图

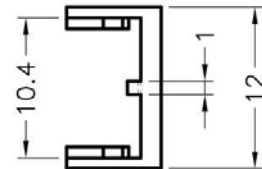

	PART NO	PACKAGE
	PAHO-030	1000

南京诺金电气有限公司

Nanjing Nowking Electric Co., Ltd

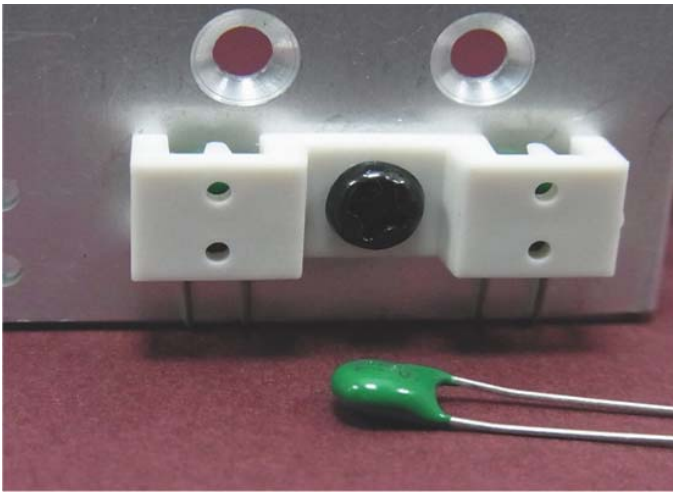

产品名称：零件垫座

规格型号：PAHO-031

◆ MATERIAL: PBT (UL)

◆ FLAME CLASS: 94V-0

◆ COLOR: NATURAL

◆ UNIT: mm

用途：用于热敏电阻接脚之固定与保护。

PAHO-031 结构图

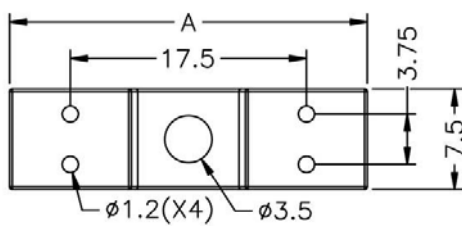
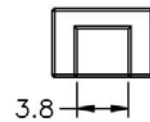
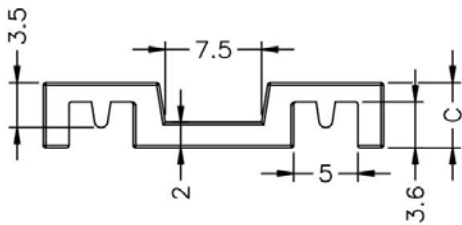

	PART NO	A	C	PACKAGE
	PAHO-031	26.5	5.1	1000

南京诺金电气有限公司

Nanjing Nowking Electric Co., Ltd

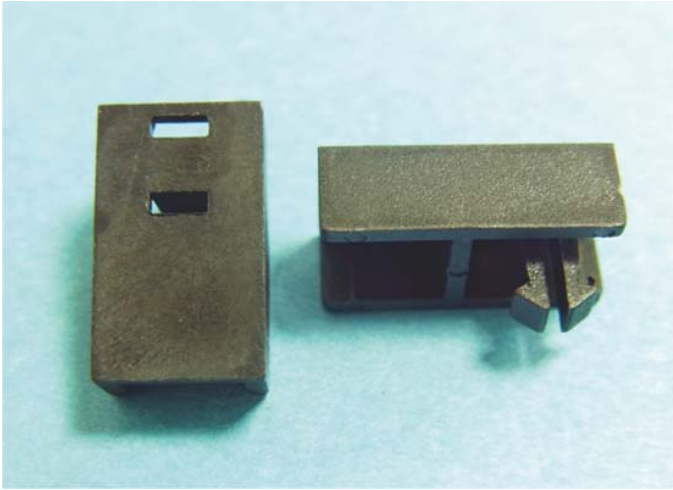

产品名称：零件垫座

规格型号：PAHO-032

- ◆ MATERIAL: NYLON 66 (UL)
- ◆ FLAME CLASS: 94V-0, 94V-2
- ◆ COLOR: NATURAL, BLACK
- ◆ UNIT: mm

用途：用于零件防尘与保护。

PAHO-032 结构图

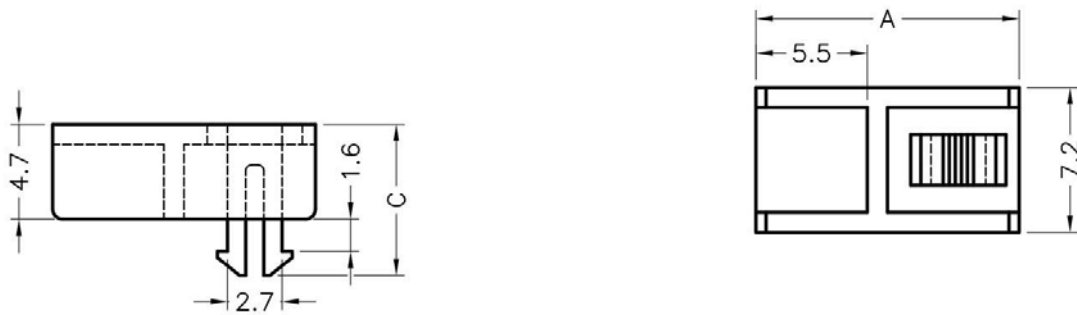

	PART NO	A	C	PACKAGE
	PAHO-032	13.0	7.5	1000

南京诺金电气有限公司

Nanjing Nowking Electric Co., Ltd

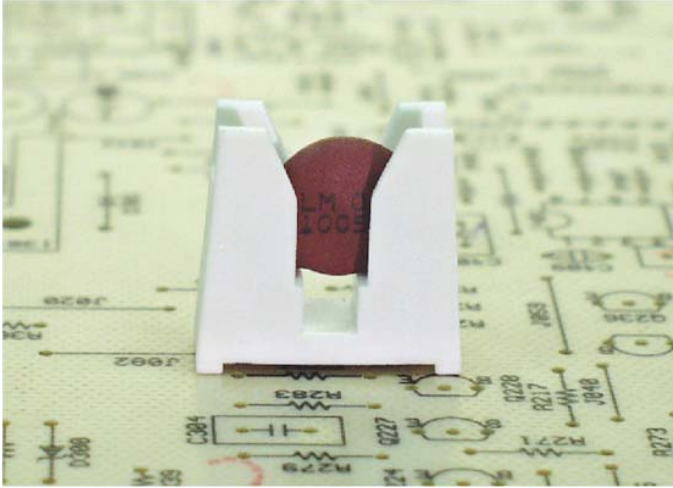

产品名称：零件垫座

规格型号：PAHO-033

- ◆ MATERIAL: PBT (UL)
- ◆ FLAME CLASS: 94V-0
- ◆ COLOR: NATURAL
- ◆ UNIT: mm

用途：用于零件接脚垫高与保护。

PAHO-033 结构图

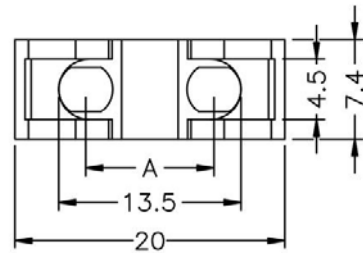
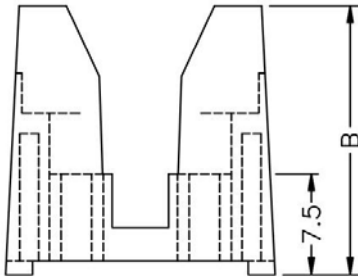

	PART NO	A	B	PACKAGE
	PAHO-033	9.5	20.0	500

南京诺金电气有限公司

Nanjing Nowking Electric Co., Ltd

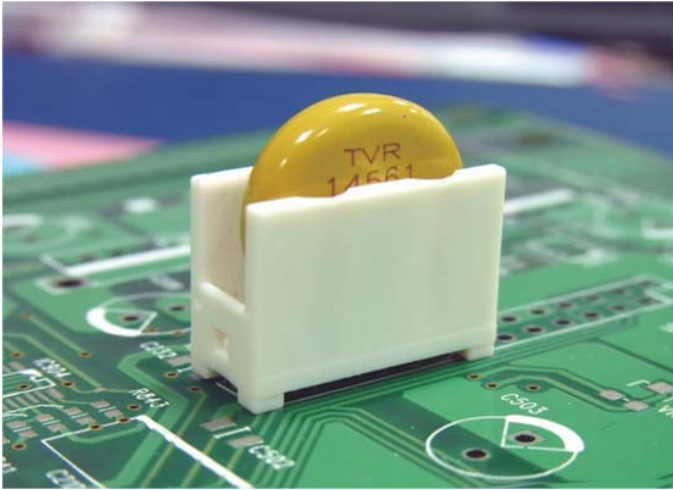

产品名称：零件垫座

规格型号：PAHO-034

- ◆ MATERIAL: PPS (UL)
- ◆ FLAME CLASS: 94V-0
- ◆ COLOR: NATURAL, BLACK
- ◆ UNIT: mm

用途：用于零件接脚垫高与保护。

PAHO-034 结构图

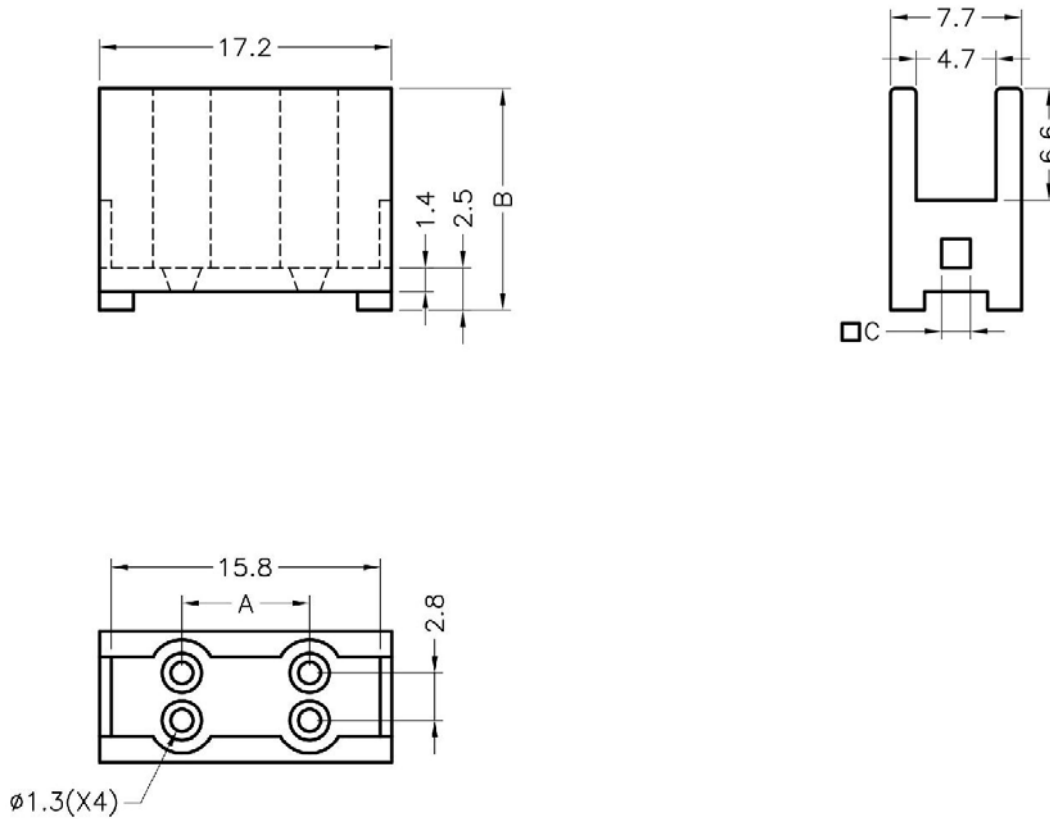

PART NO	A	B	C	PACKAGE
PAHO-034	7.2	14.5	-	500

南京诺金电气有限公司

Nanjing Nowking Electric Co., Ltd

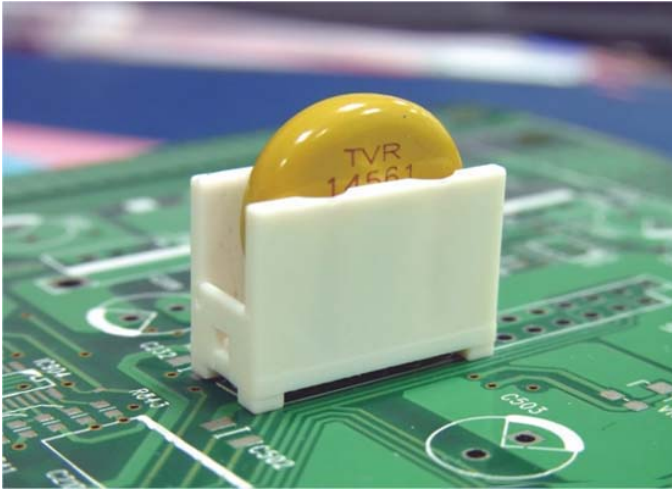

产品名称：零件垫座

规格型号：PAHO-035

- ◆ MATERIAL: PPS (UL)
- ◆ FLAME CLASS: 94V-0
- ◆ COLOR: NATURAL, BLACK
- ◆ UNIT: mm

用途：用于零件接脚垫高与保护。

PAHO-035 结构图

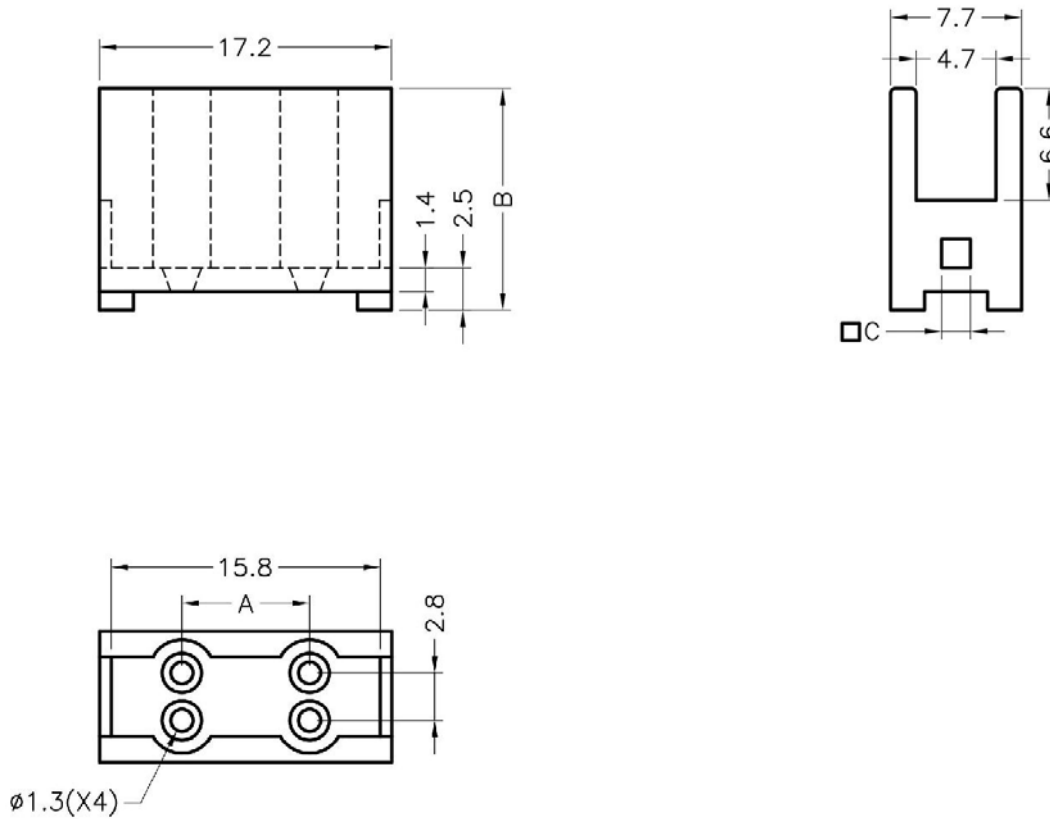

PART NO	A	B	C	PACKAGE
PAHO-035	7.5	13.1	1.7	500

南京诺金电气有限公司

Nanjing Nowking Electric Co., Ltd

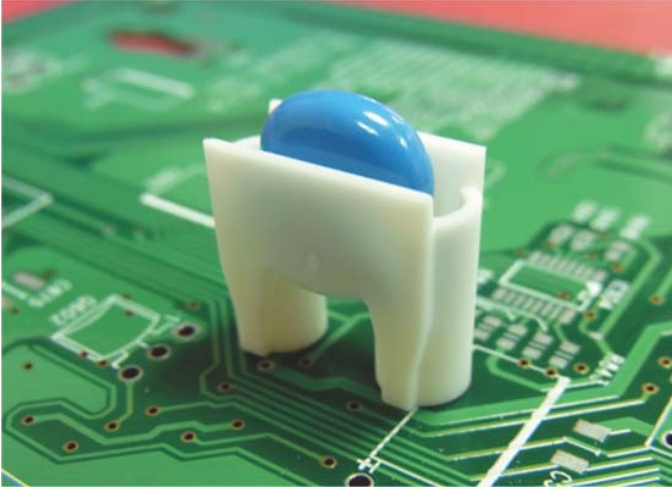

产品名称：零件垫座

规格型号：PAHO-036

◆ MATERIAL: NYLON 66 (UL)

◆ FLAME CLASS: 94V-0, 94V-2

◆ COLOR: NATURAL, BLACK

◆ UNIT: mm

用途：用于零件接脚垫高与保护。

PAHO-036 结构图

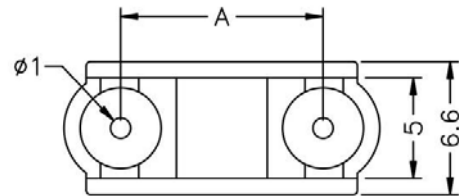
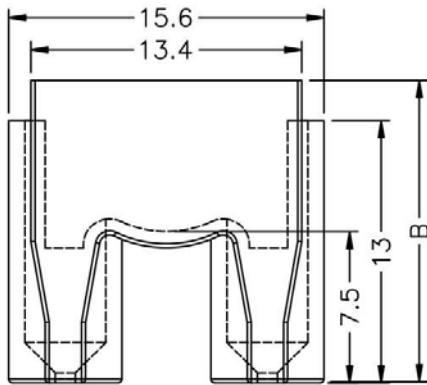

PART NO	A	B	-	PACKAGE
PAHO-036	10.0	15.0	-	500

南京诺金电气有限公司

Nanjing Nowking Electric Co., Ltd

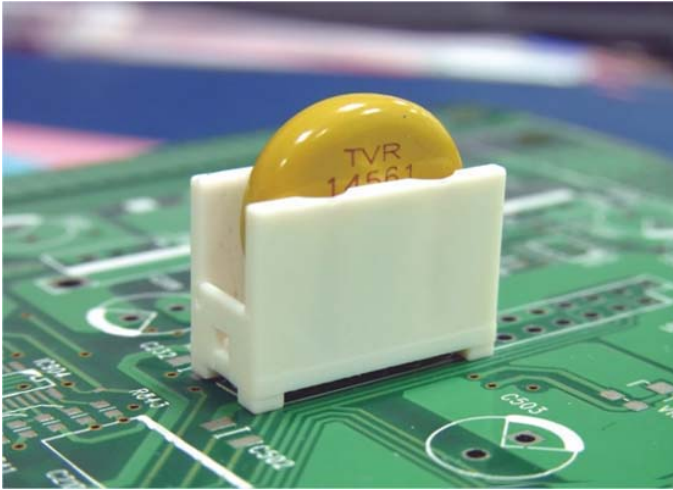

产品名称：零件垫座

规格型号：PAHO-037

- ◆ MATERIAL: PPS (UL)
- ◆ FLAME CLASS: 94V-0
- ◆ COLOR: NATURAL, BLACK
- ◆ UNIT: mm

用途：用于零件接脚垫高与保护。

PAHO-037 结构图

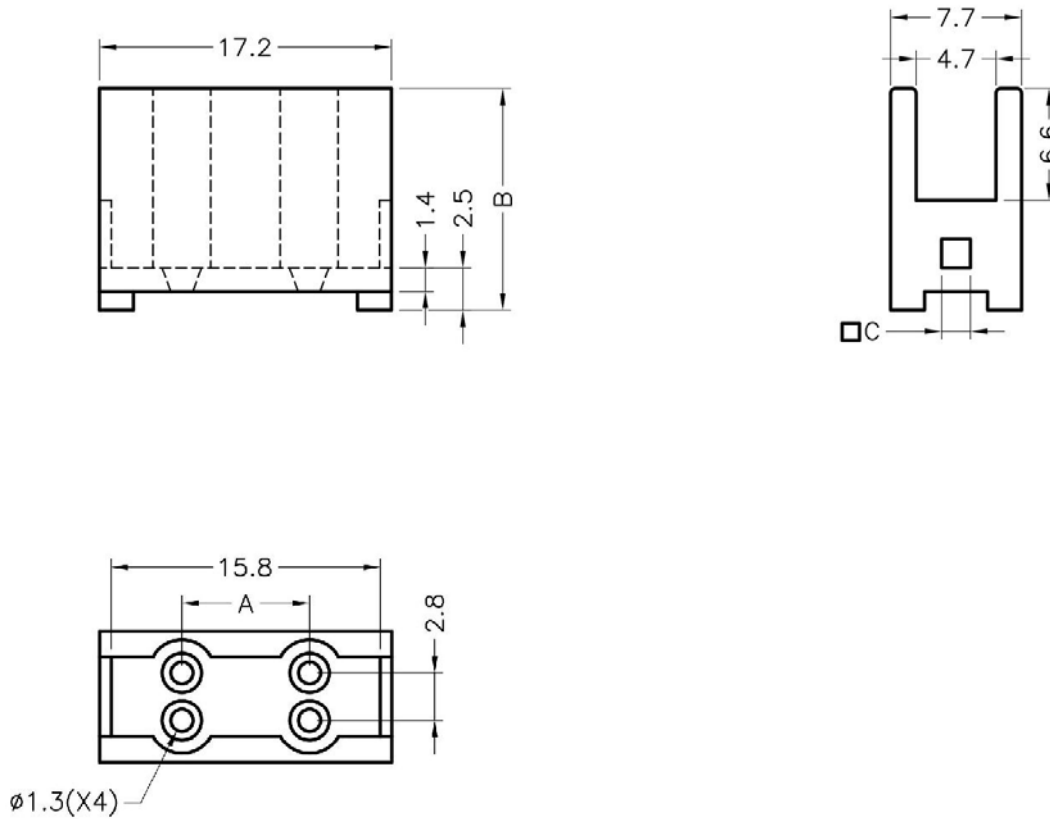

PART NO	A	B	C	PACKAGE
PAHO-037	7.5	13.1	-	500

南京诺金电气有限公司

Nanjing Nowking Electric Co., Ltd



产品名称：零件垫座

规格型号：PAHO-038

- ◆ MATERIAL: NYLON 66 (UL)
- ◆ FLAME CLASS: 94V-0, 94V-2
- ◆ COLOR: NATURAL, BLACK
- ◆ UNIT: mm

用途：用于零件接脚垫高与保护。

PAHO-038 结构图

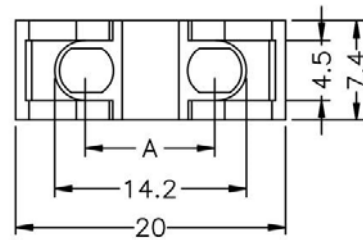
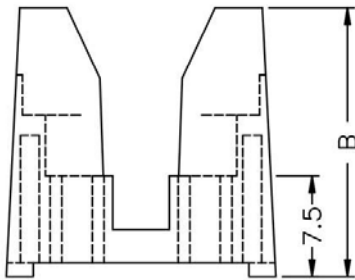

	PART NO	A	B	C	PACKAGE
	PAHO-038	9.5	20.0	-	1000

南京诺金电气有限公司

Nanjing Nowking Electric Co., Ltd

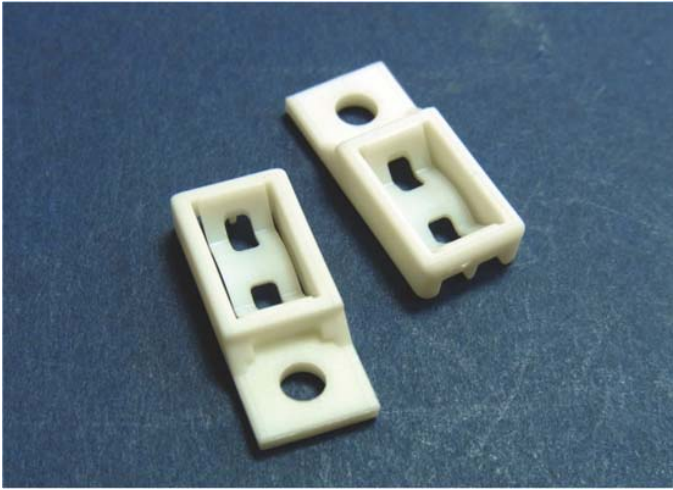

产品名称：零件垫座

规格型号：PAHO-039

◆ MATERIAL: NYLON 66 (UL)

◆ FLAME CLASS: 94V-0

◆ COLOR: NATURAL

◆ UNIT: mm

用途：用于热敏电阻接脚之固定与保护。

PAHO-039 结构图

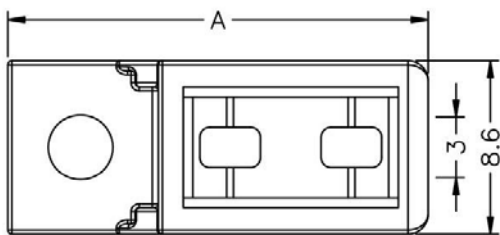
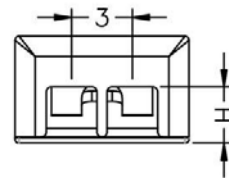
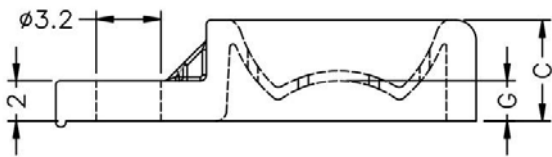

	PART NO	A	C	G	H	PACKAGE
	PAHO-039	20.8	5.0	2.0	2.5	1000

南京诺金电气有限公司

Nanjing Nowking Electric Co., Ltd

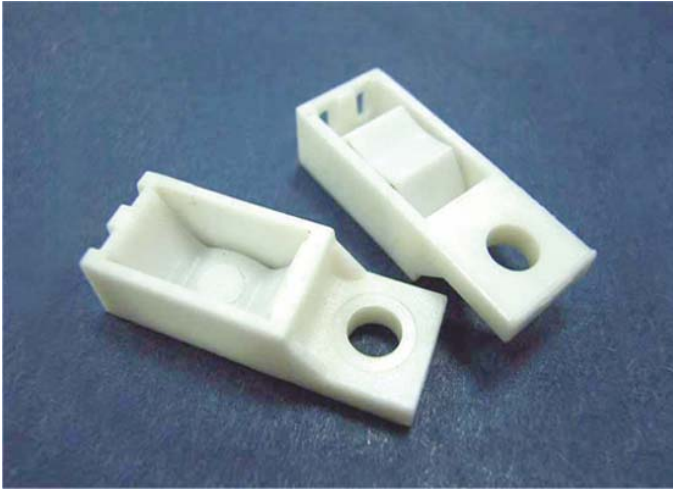

产品名称：零件垫座

规格型号：PAHO-040

- ◆ MATERIAL: NYLON 66 (UL)
- ◆ FLAME CLASS: 94V-0, 94V-2
- ◆ COLOR: NATURAL, BLACK
- ◆ UNIT: mm

用途：用于热敏电阻接脚之固定与保护。

PAHO-040 结构图

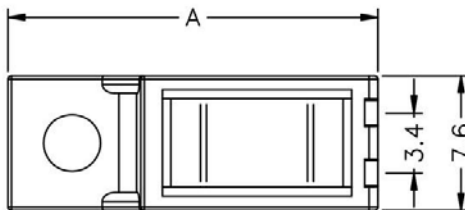
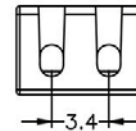
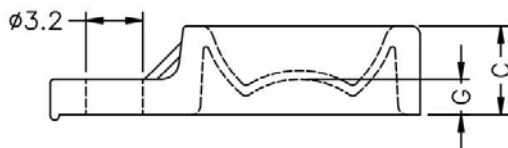

	PART NO	A	C	G	PACKAGE
	PAHO-040	20.8	5.0	0.71	1000

南京诺金电气有限公司

Nanjing Nowking Electric Co., Ltd

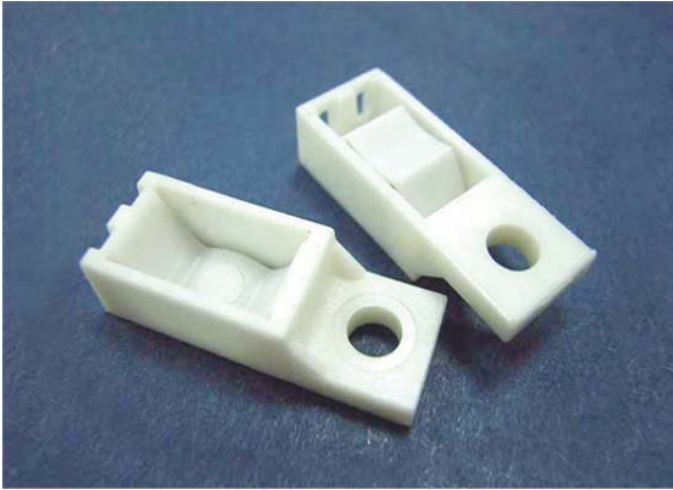

产品名称：零件垫座

规格型号：PAHO-041

- ◆ MATERIAL: NYLON 66 (UL)
- ◆ FLAME CLASS: 94V-0, 94V-2
- ◆ COLOR: NATURAL, BLACK
- ◆ UNIT: mm

用途：用于热敏电阻接脚之固定与保护。

PAHO-041 结构图

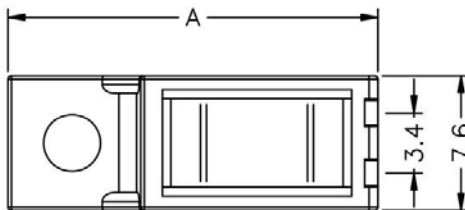
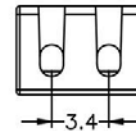
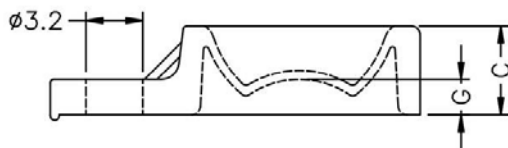

	PART NO	A	C	G	PACKAGE
	PAHO-041	20.8	5.0	2.0	1000

南京诺金电气有限公司

Nanjing Nowking Electric Co., Ltd



产品名称：零件垫座

规格型号：PAHO-042

- ◆ MATERIAL: NYLON 66 (UL)
- ◆ FLAME CLASS: 94V-0, 94V-2
- ◆ COLOR: NATURAL, BLACK
- ◆ UNIT: mm

用途：用于热敏电阻接脚之固定与保护。

PAHO-042 结构图

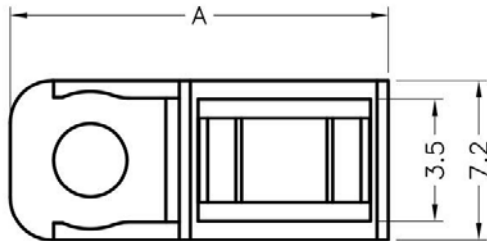
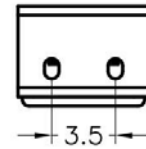
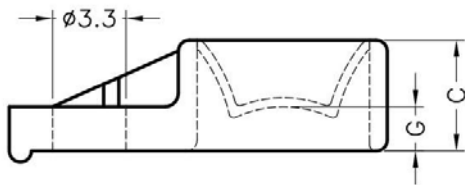

	PART NO	A	C	G	PACKAGE
	PAHO-042	17.0	5.0	2.0	1000

南京诺金电气有限公司

Nanjing Nowking Electric Co., Ltd

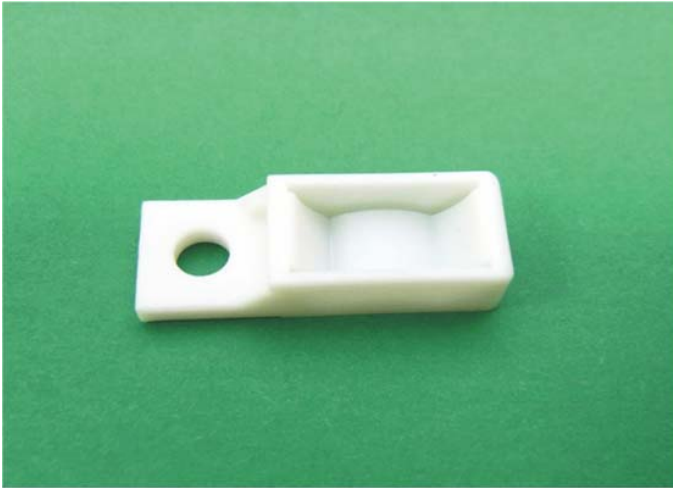

产品名称：零件垫座

规格型号：PAHO-043

- ◆ MATERIAL: NYLON 66 (UL)
- ◆ FLAME CLASS: 94V-0, 94V-2
- ◆ COLOR: NATURAL, BLACK
- ◆ UNIT: mm

用途：用于热敏电阻接脚之固定与保护。

PAHO-043 结构图

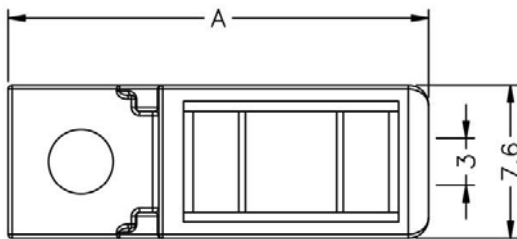
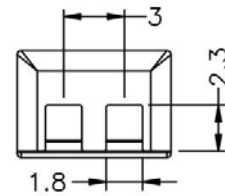

	PART NO	A	C	G	PACKAGE
	PAHO-043	20.8	5.0	1.1	1000

南京诺金电气有限公司

Nanjing Nowking Electric Co., Ltd

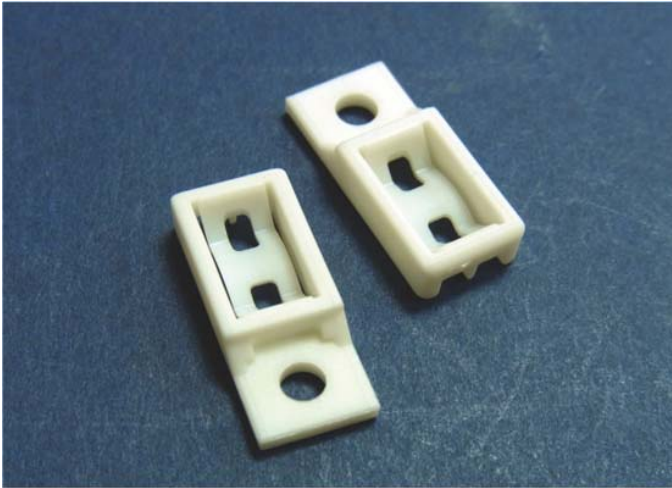

产品名称：零件垫座

规格型号：PAHO-044

◆ MATERIAL: NYLON 66 (UL)

◆ FLAME CLASS: 94V-0

◆ COLOR: NATURAL

◆ UNIT: mm

用途：用于热敏电阻接脚之固定与保护。

PAHO-044 结构图

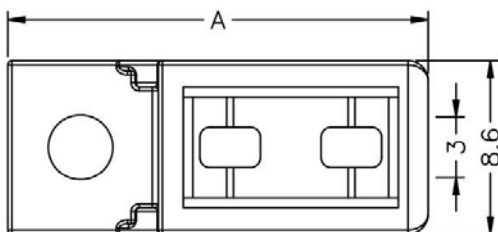
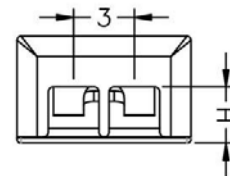
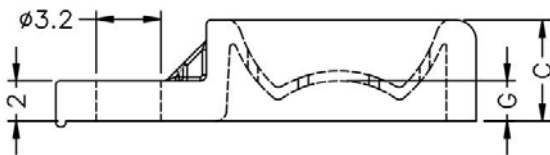

	PART NO	A	C	G	H	PACKAGE
	PAHO-044	20.8	5.0	2.0	1.2	1000

南京诺金电气有限公司

Nanjing Nowking Electric Co., Ltd

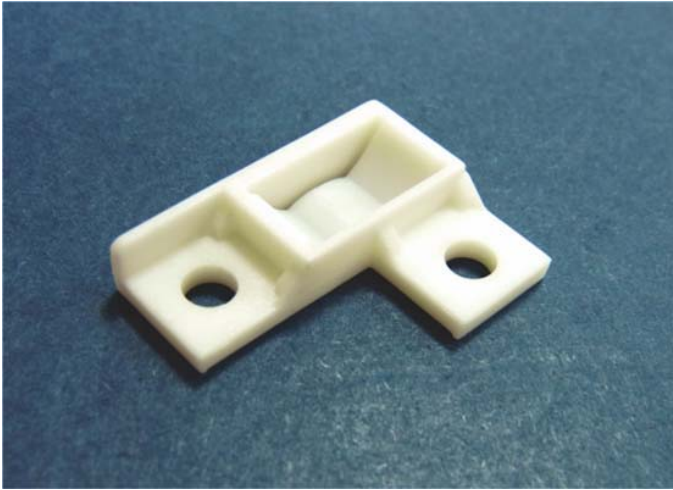

产品名称：零件垫座

规格型号：PAHO-045

◆ MATERIAL: NYLON 66 (UL)

◆ FLAME CLASS: 94V-0, 94V-2

◆ COLOR: NATURAL, BLACK

◆ UNIT: mm

用途：用于热敏电阻接脚之固定与保护。

PAHO-045 结构图

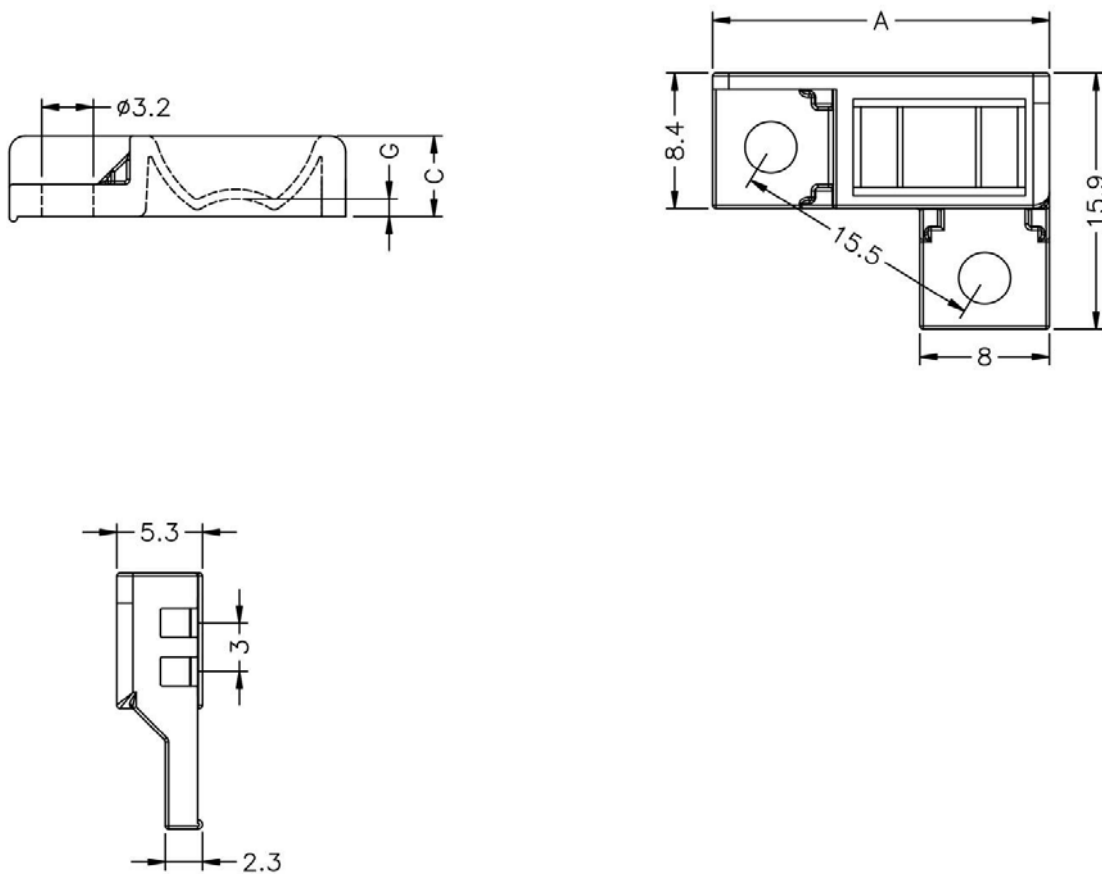

PART NO	A	C	G	-	PACKAGE
PAHO-045	20.8	5.0	1.1	-	1000

南京诺金电气有限公司

Nanjing Nowking Electric Co., Ltd

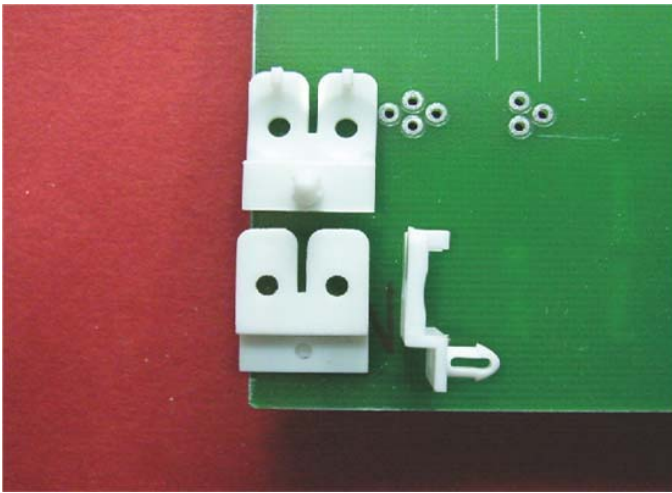

产品名称：零件垫座

规格型号：PAHO-046

- ◆ MATERIAL: NYLON 66 (UL)
- ◆ FLAME CLASS: 94V-0, 94V-2
- ◆ COLOR: NATURAL, BLACK
- ◆ UNIT: mm

用途：用于热敏电阻接脚之固定与保护。

PAHO-046 结构图

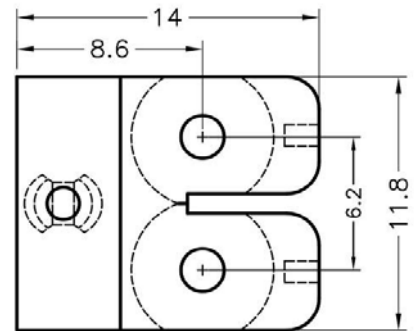
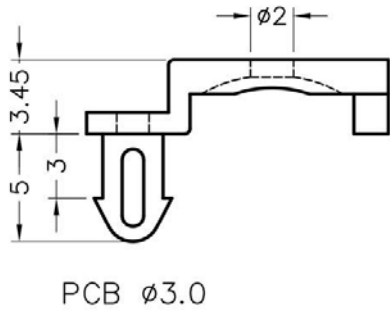

	PART NO	PACKAGE
	PAHO-046	1000

南京诺金电气有限公司

Nanjing Nowking Electric Co., Ltd



产品名称：零件垫座

规格型号：PAHO-047

- ◆ MATERIAL: PBT(UL)
- ◆ FLAME CLASS: 94V-0
- ◆ COLOR: NATURAL
- ◆ UNIT: mm

用途：用于热敏电阻接脚之固定与保护。

PAHO-047 结构图

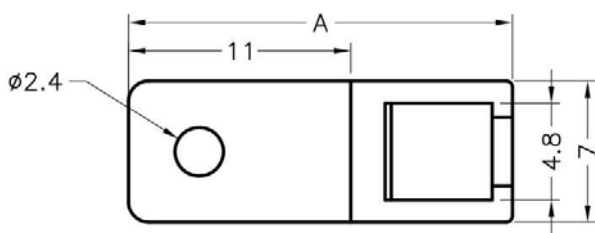
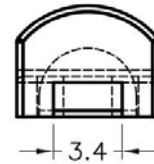
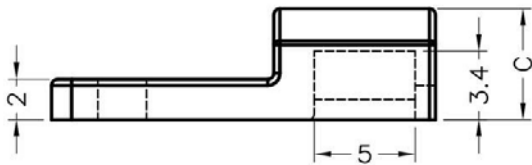

	PART NO	A	C	E	PACKAGE
	PAHO-047	19.0	3.4	3.2	1000

南京诺金电气有限公司

Nanjing Nowking Electric Co., Ltd

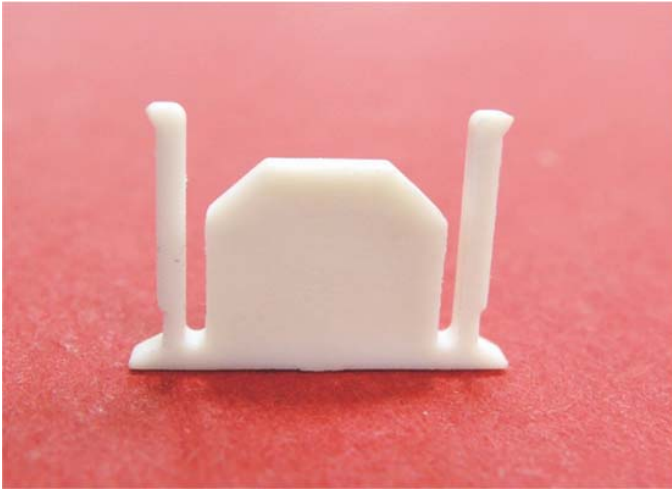

产品名称：零件垫座

规格型号：PAHO-048

◆ MATERIAL: PBT (UL)

◆ FLAME CLASS: 94V-0

◆ COLOR: NATURAL

◆ UNIT: mm

用途：用于热敏电阻接脚之固定与保护。

PAHO-048 结构图

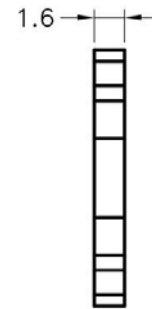
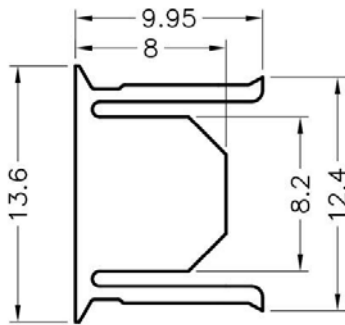

	PART NO	PACKAGE
	PAHO-048	1000

南京诺金电气有限公司

Nanjing Nowking Electric Co., Ltd

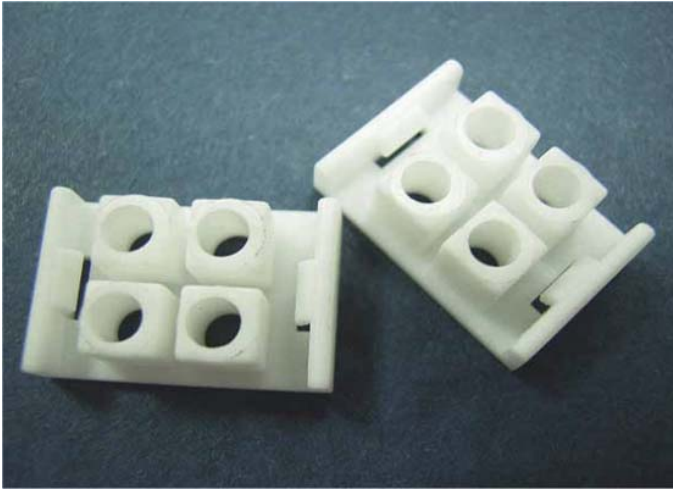

产品名称：零件垫座

规格型号：PAHO-049

◆ MATERIAL: NYLON 66 (UL)

◆ FLAME CLASS: 94V-0, 94V-2

◆ COLOR: NATURAL, BLACK

◆ UNIT: mm

用途：用于连接器的保护。

PAHO-049 结构图

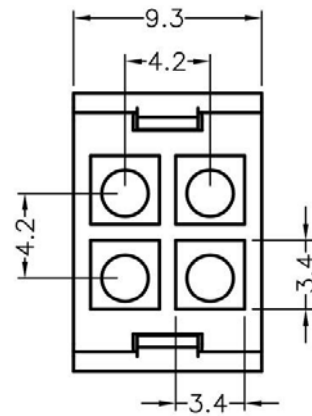
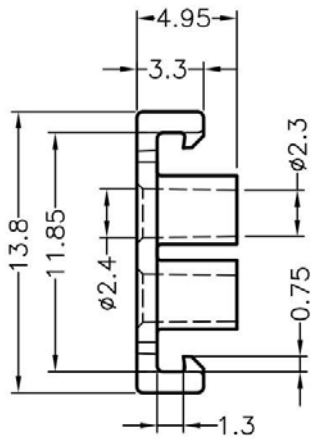

	PART NO	PACKAGE
	PAHO-049	1000



产品名称：零件垫座

规格型号：PAHO-050

- ◆ MATERIAL: NYLON 66 (UL)
- ◆ FLAME CLASS: 94V-0, 94V-2
- ◆ COLOR: NATURAL, BLACK
- ◆ UNIT: mm

用途：用于热敏电阻接脚固定与保护。

可使用同等材质

PAHO-050 结构图

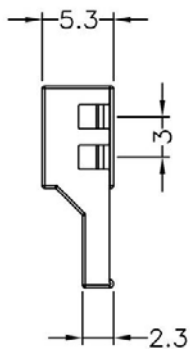
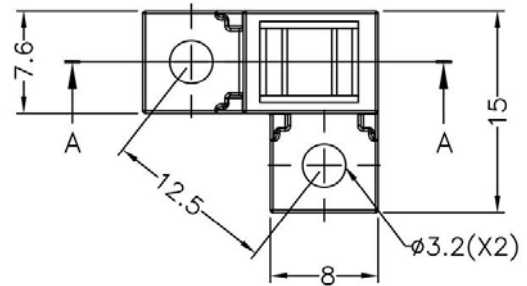
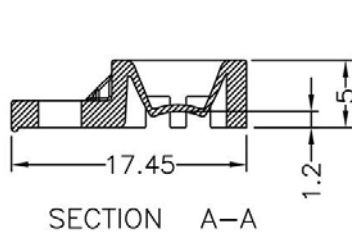

	PART NO	PACKAGE
	PAHO-050	1000

南京诺金电气有限公司

Nanjing Nowking Electric Co., Ltd

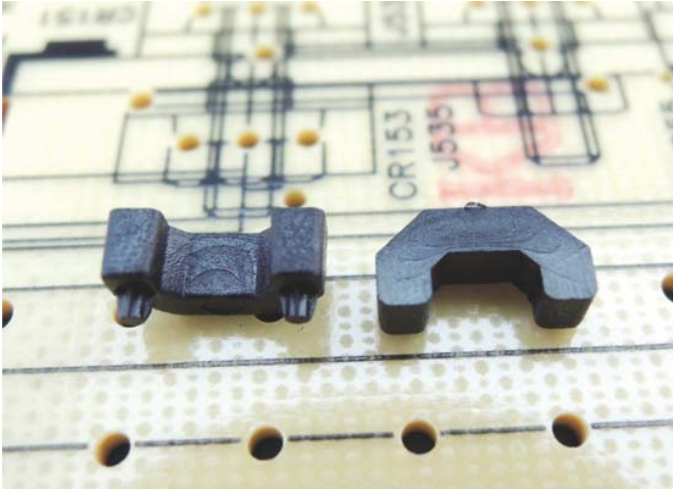

产品名称：零件垫座

规格型号：PAHO-051

- ◆ MATERIAL: PC (UL)
- ◆ FLAME CLASS: 94V-0
- ◆ COLOR: BLACK
- ◆ UNIT: mm

用途：用于电源供应器，防 IC 球击保护之垫片。

PAHO-051 结构图

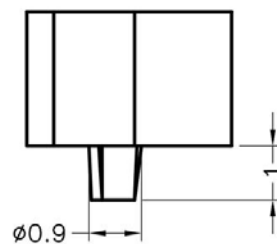
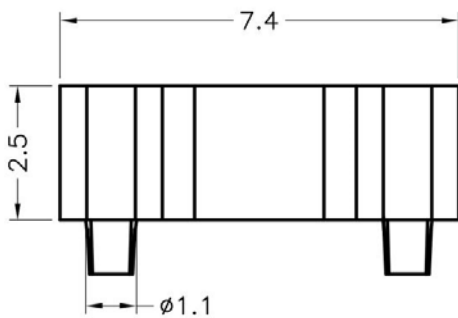
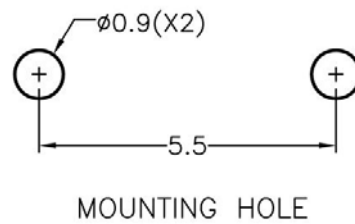
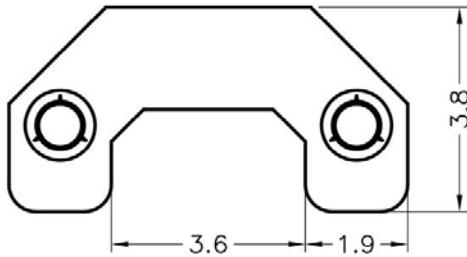

PART NO	PACKAGE
PAHO-051	2000

南京诺金电气有限公司

Nanjing Nowking Electric Co., Ltd

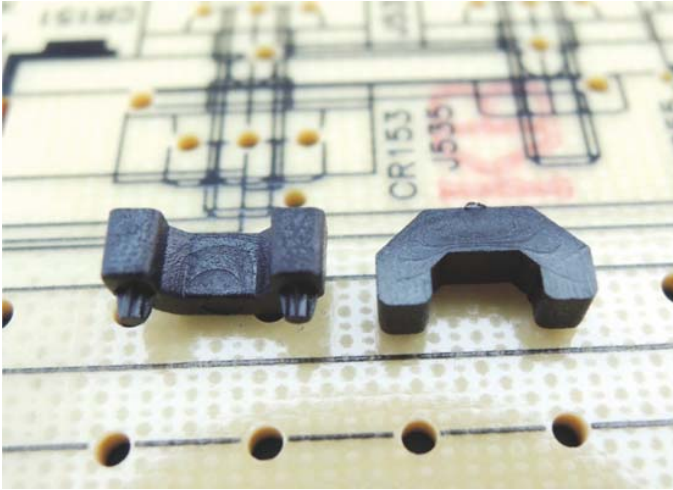

产品名称：零件垫座

规格型号：PAHO-052

- ◆ MATERIAL: PC (UL)
- ◆ FLAME CLASS: 94V-0
- ◆ COLOR: BLACK
- ◆ UNIT: mm

用途：用于电源供应器，防 IC 球击保护之垫片。

PAHO-052 结构图

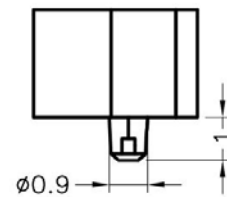
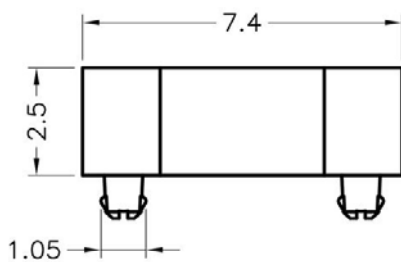
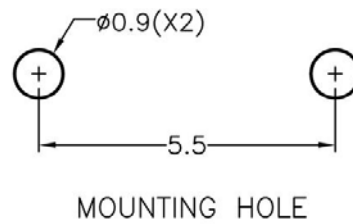
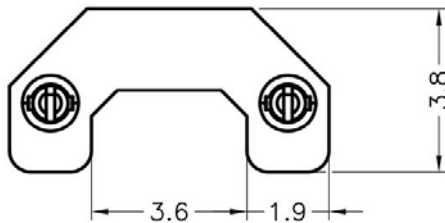

	PART NO	PACKAGE
	PAHO-052	2000

产品名称：零件垫座

规格型号：PAHO-053

- ◆ MATERIAL: PC (UL)
- ◆ FLAME CLASS: 94V-0
- ◆ COLOR: BLACK
- ◆ UNIT: mm

用途：用于电源供应器，防 IC 球击保护之垫片。



PAHO-053 结构图

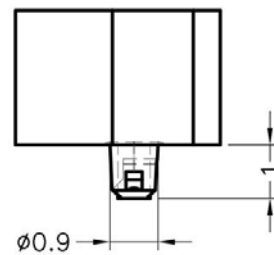
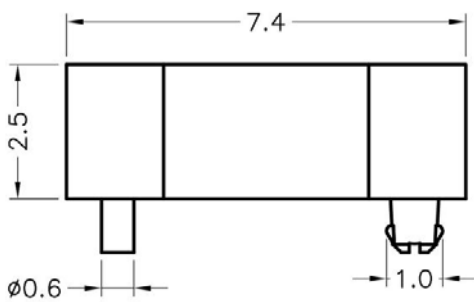
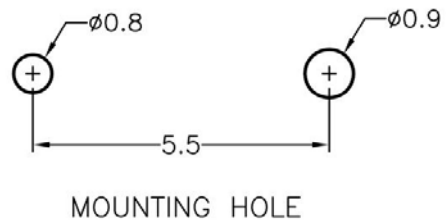
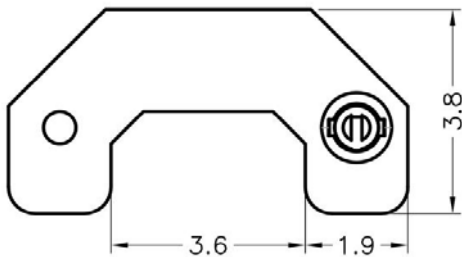

	PART NO	PACKAGE
	PAHO-053	2000

南京诺金电气有限公司

Nanjing Nowking Electric Co., Ltd

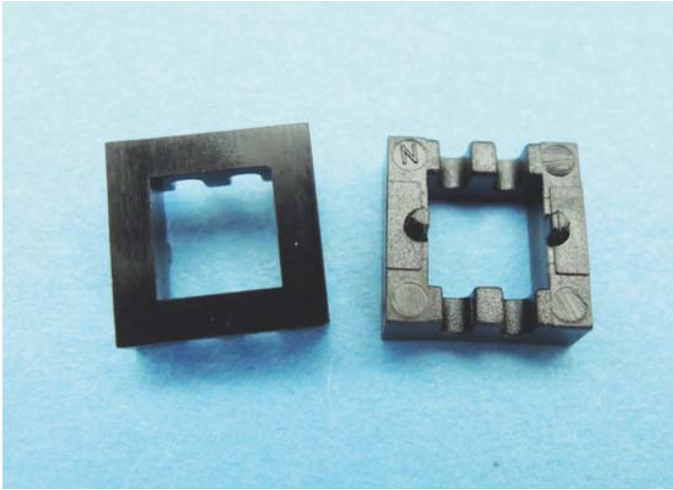

产品名称：零件垫座

规格型号：PAHO-054

- ◆ MATERIAL: PC (UL)
- ◆ FLAME CLASS: 94V-0
- ◆ COLOR: BLACK
- ◆ UNIT: mm

用途：用于电源供应器，防 IC 球击保护之垫片。

PAHO-054 结构图

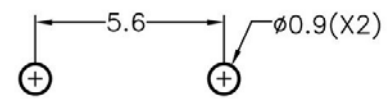
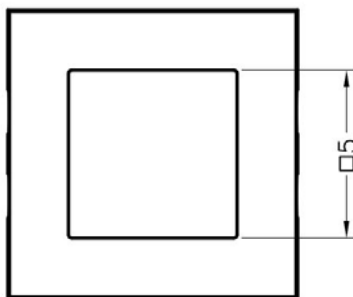
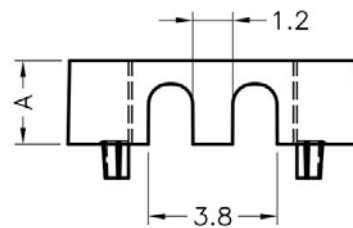
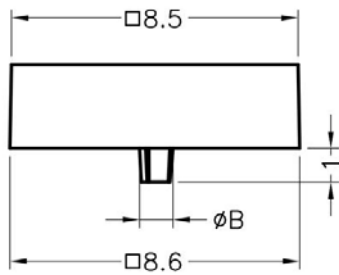

MOUNTING HOLES

PART NO	A	B	PACKAGE
PAHO-054	2.5	0.9	2000

南京诺金电气有限公司

Nanjing Nowking Electric Co., Ltd

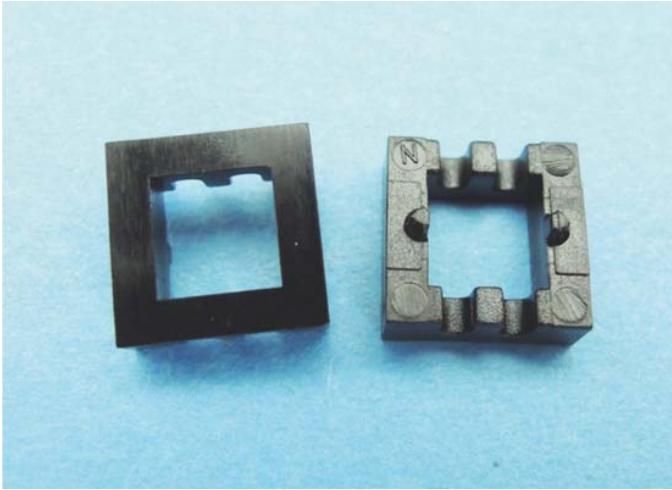

产品名称：零件垫座

规格型号：PAHO-055

- ◆ MATERIAL: PC (UL)
- ◆ FLAME CLASS: 94V-0
- ◆ COLOR: BLACK
- ◆ UNIT: mm

用途：用于电源供应器，防 IC 球击保护之垫片。

PAHO-055 结构图

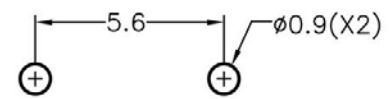
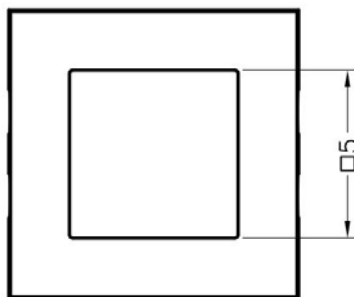
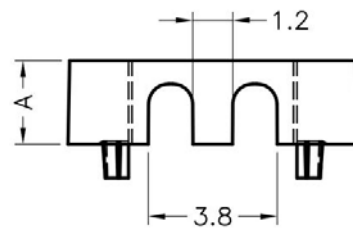
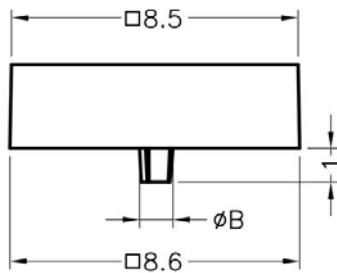

MOUNTING HOLES

PART NO	A	B	PACKAGE
PAHO-055	3.0	1.08	2000

南京诺金电气有限公司

Nanjing Nowking Electric Co., Ltd

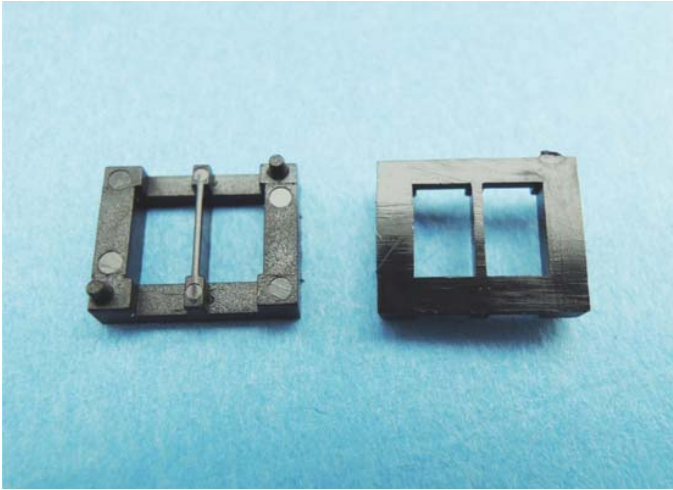

产品名称: 零件垫座

规格型号: PAHO-056

- ◆ MATERIAL: PC (UL)
- ◆ FLAME CLASS: 94V-0
- ◆ COLOR: BLACK
- ◆ UNIT: mm

用途: 用于电源供应器, 防 IC 球击, 保护之垫片。

PAHO-056 结构图

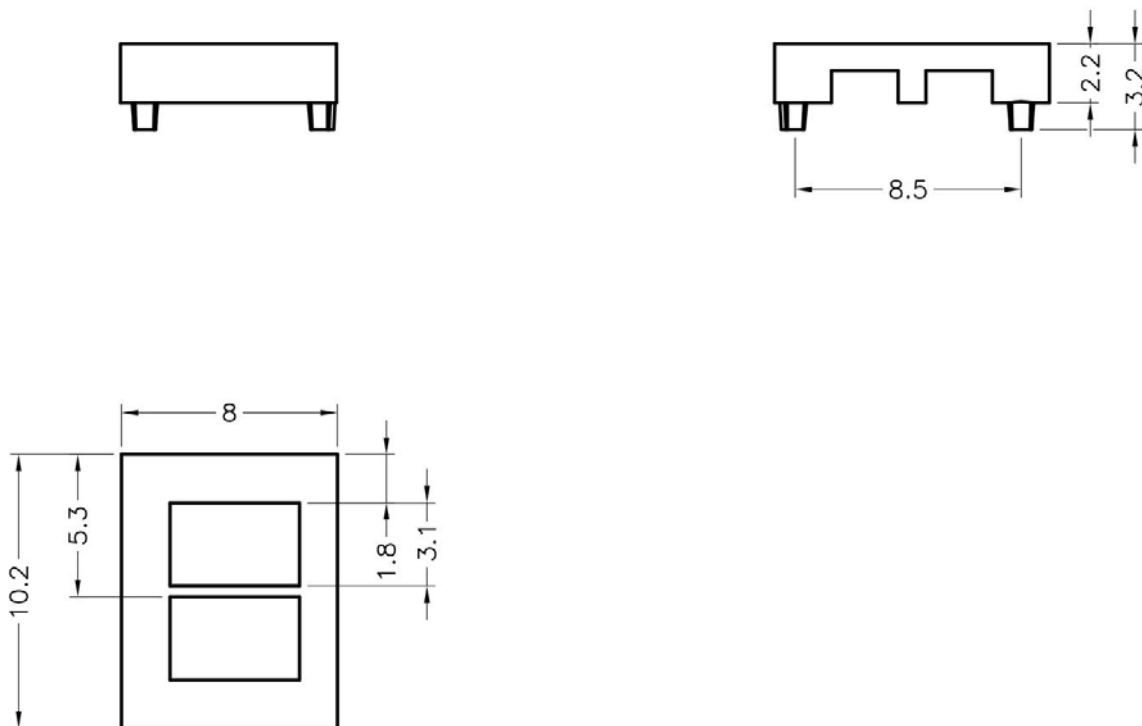

	PART NO	PACKAGE
	PAHO-056	2000

南京诺金电气有限公司

Nanjing Nowking Electric Co., Ltd

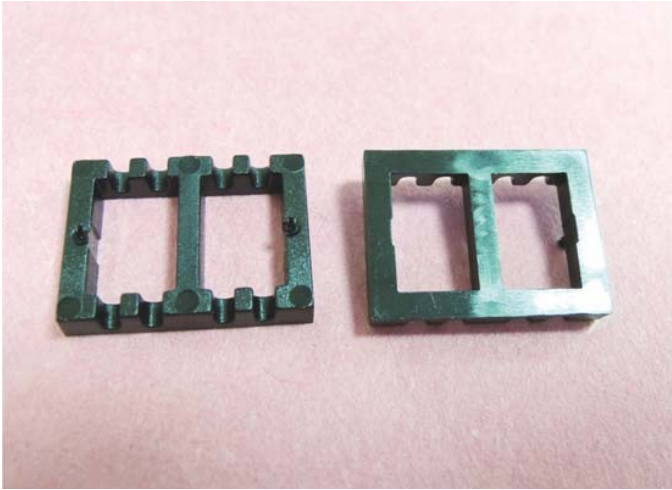

产品名称：零件垫座

规格型号：PAHO-057

- ◆ MATERIAL: PC (UL)
- ◆ FLAME CLASS: 94V-0
- ◆ COLOR: BLACK
- ◆ UNIT: mm

用途：用于电源供应器，防 IC 球击,保护之垫片。

PAHO-057 结构图

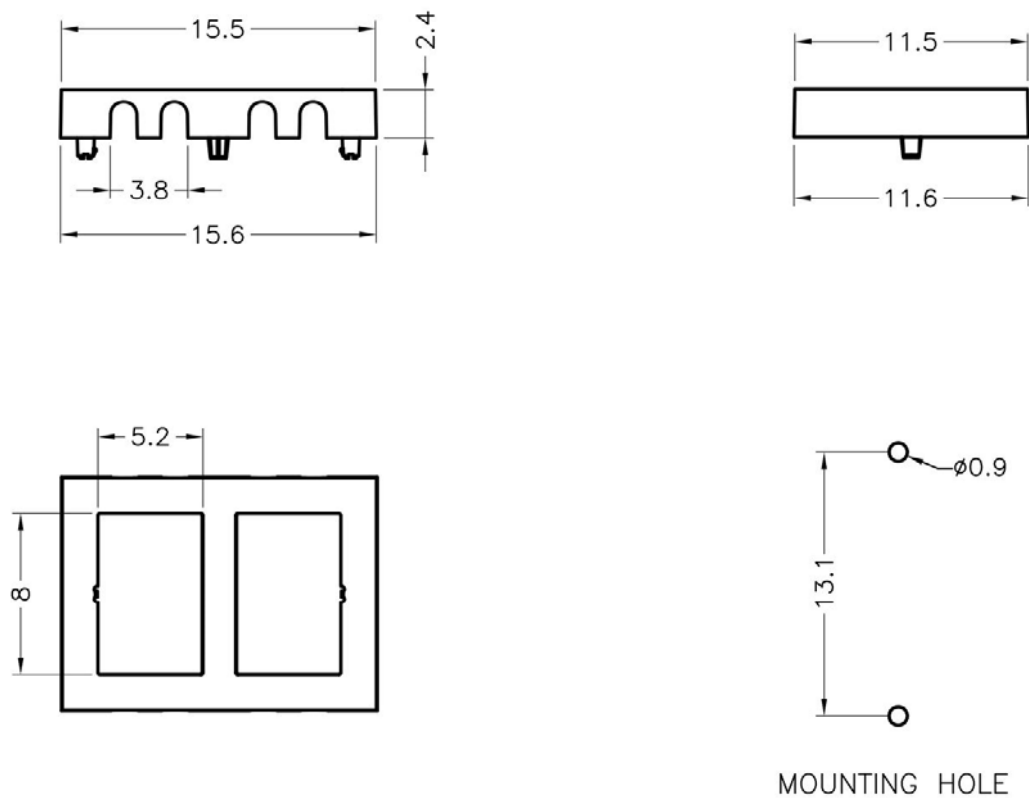

PART NO	PACKAGE
PAHO-057	1000

南京诺金电气有限公司

Nanjing Nowking Electric Co., Ltd

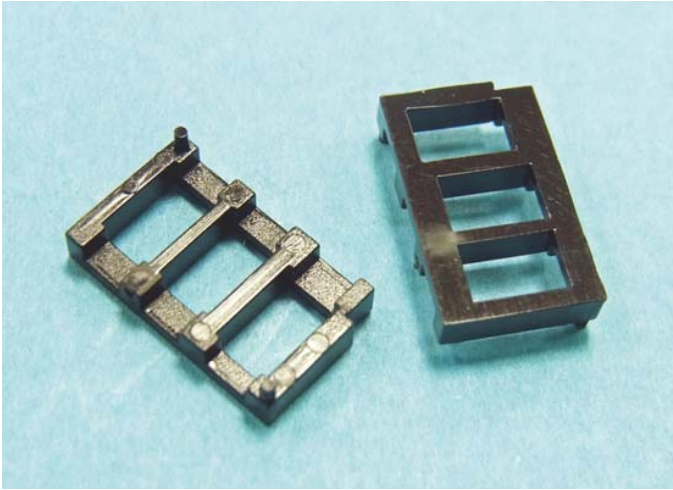

产品名称：零件垫座

规格型号：PAHO-058

- ◆ MATERIAL: PC (UL)
- ◆ FLAME CLASS: 94V-0
- ◆ COLOR: BLACK
- ◆ UNIT: mm

用途：用于电源供应器，防三颗 IC 球击,保护之垫片。

PAHO-058 结构图

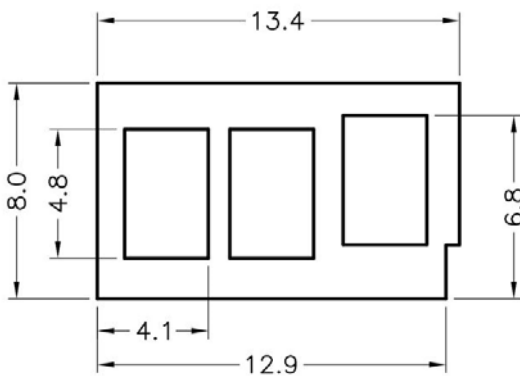
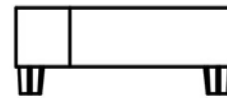
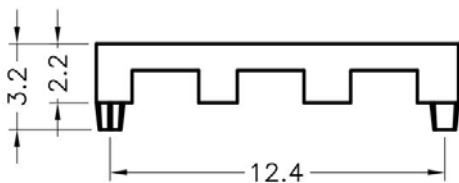

	PART NO	PACKAGE
	PAHO-058	1000

南京诺金电气有限公司

Nanjing Nowking Electric Co., Ltd



产品名称：零件垫座

规格型号：PAHO-059

- ◆ MATERIAL: PC (UL)
- ◆ FLAME CLASS: 94V-0
- ◆ COLOR: BLACK
- ◆ UNIT: mm

用途：用于电源供应器，防 IC 球击,保护之垫片。

PAHO-059 结构图

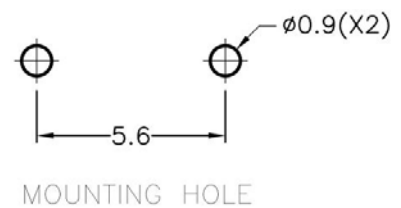
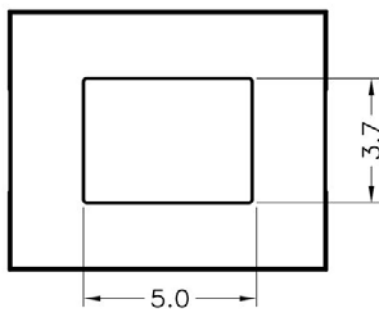
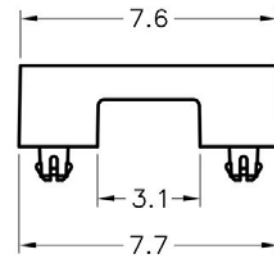
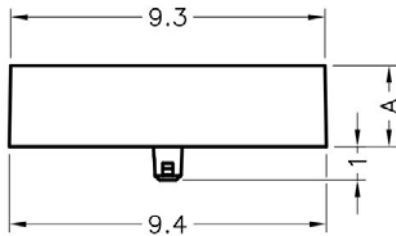

	PART NO	A	PACKAGE
	PAHO-059	2.4	2000

南京诺金电气有限公司

Nanjing Nowking Electric Co., Ltd

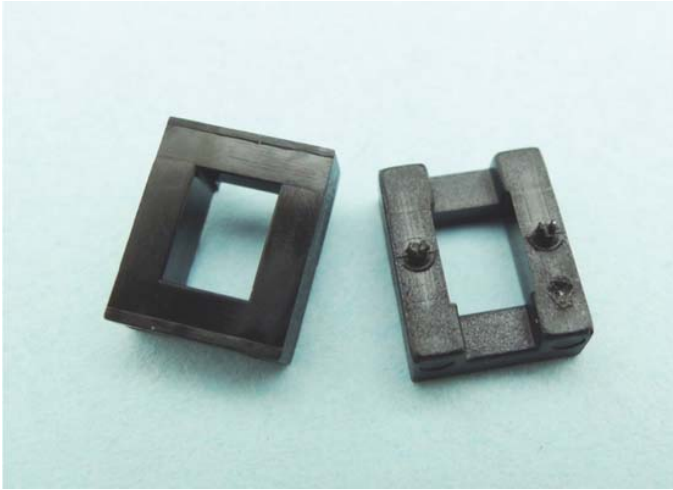

产品名称：零件垫座

规格型号：PAHO-060

- ◆ MATERIAL: PC (UL)
- ◆ FLAME CLASS: 94V-0
- ◆ COLOR: BLACK
- ◆ UNIT: mm

用途：用于电源供应器，防 IC 球击,保护之垫片。

PAHO-060 结构图

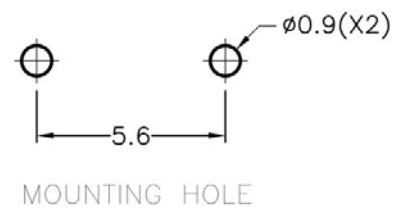
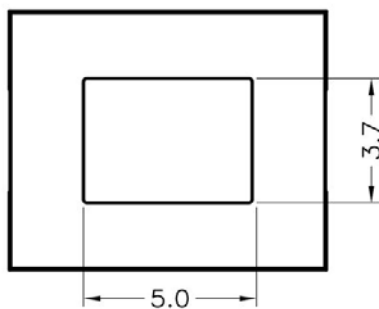
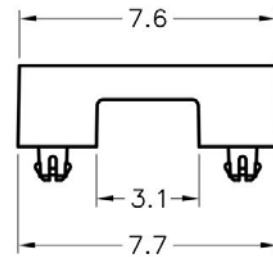
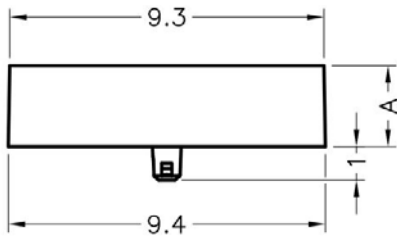

	PART NO	A	PACKAGE
	PAHO-060	2.9	2000

南京诺金电气有限公司

Nanjing Nowking Electric Co., Ltd

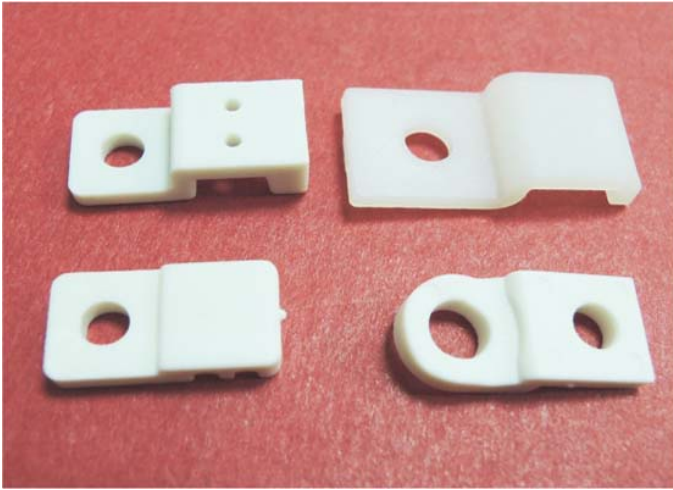

产品名称：零件垫座

规格型号：PAHO-061

- ◆MATERIAL:PBT(UL)
- ◆FLAME CLASS:94V-0
- ◆COLOR:WHITE,NATURAL
- ◆UNIT: mm

用途：用于热敏电阻接脚之固定与保护。

MATERIAL 1 为耐高温

PAHO-061 结构图

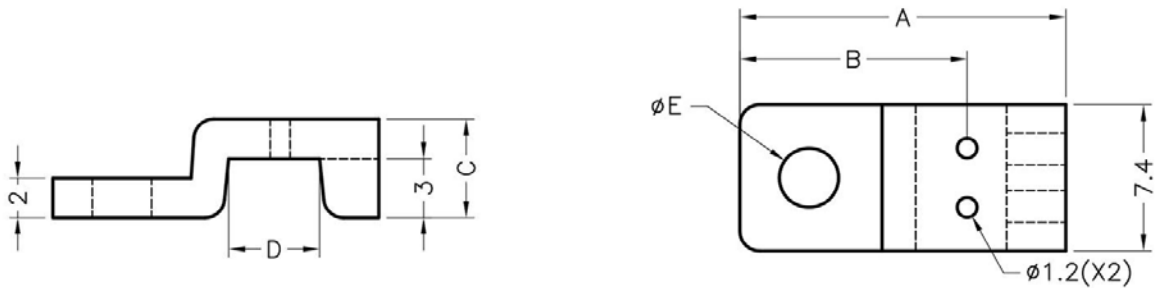

PART NO	A	B	C	D	E	PACKAGE
PAHO-061	16.5	11.5	5.0	4.7	5.15	1000

南京诺金电气有限公司

Nanjing Nowking Electric Co., Ltd

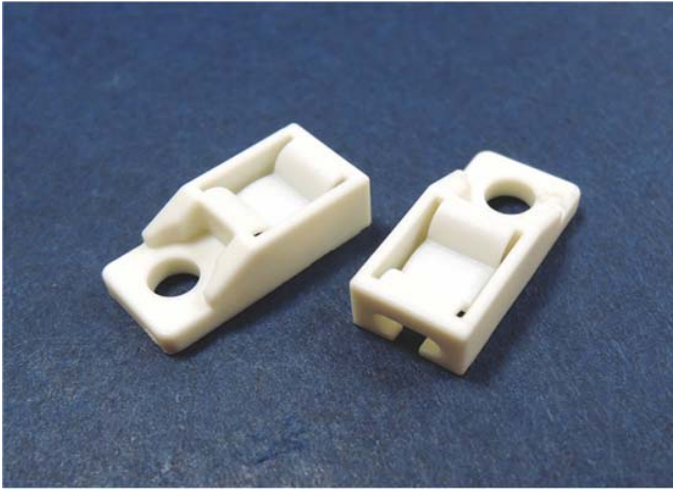

产品名称：零件垫座

规格型号：PAHO-062

- ◆ MATERIAL: NYLON 66 (UL)
- ◆ FLAME CLASS: 94V-0, 94V-2
- ◆ COLOR: NATURAL, BLACK
- ◆ UNIT: mm

用途：用于热敏电阻接脚之固定与保护。

PAHO-062 结构图

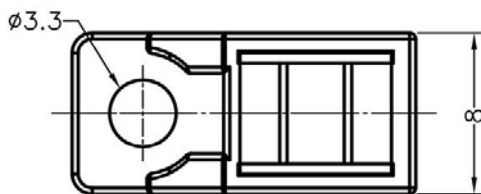
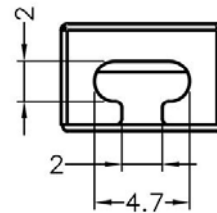
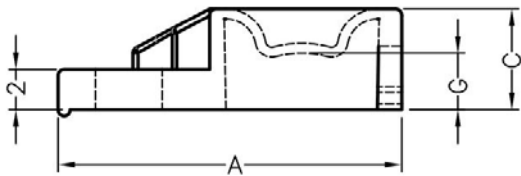

PART NO	A	C	G	-	PACKAGE
PAHO-062	17.0	5.0	2.8	-	1000

南京诺金电气有限公司

Nanjing Nowking Electric Co., Ltd

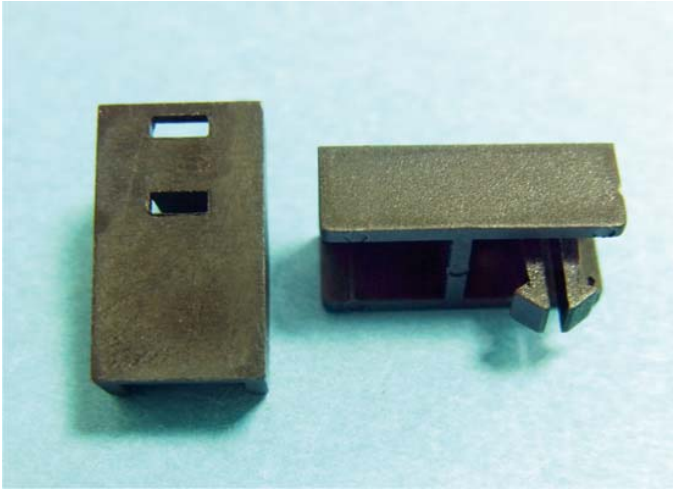

产品名称：零件垫座

规格型号：PAHO-063

- ◆ MATERIAL: NYLON 66 (UL)
- ◆ FLAME CLASS: 94V-0, 94V-2
- ◆ COLOR: NATURAL, BLACK
- ◆ UNIT: mm

用途：用于零件防尘与保护。

PAHO-063 结构图

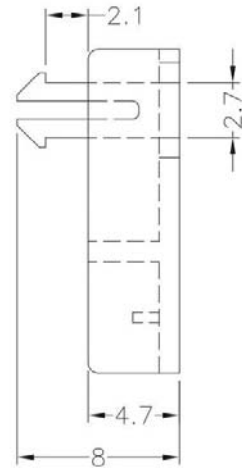
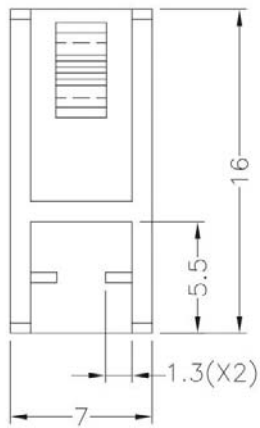

	PART NO	PACKAGE
	PAHO-063	1000

南京诺金电气有限公司

Nanjing Nowking Electric Co., Ltd



产品名称：零件垫座

规格型号：PAHO-064

- ◆ MATERIAL: NYLON 66 (UL)
- ◆ FLAME CLASS: 94V-0, 94V-2
- ◆ COLOR: NATURAL, BLACK
- ◆ UNIT: mm

用途：用于热敏电阻接脚之固定与保护。

PAHO-064 结构图

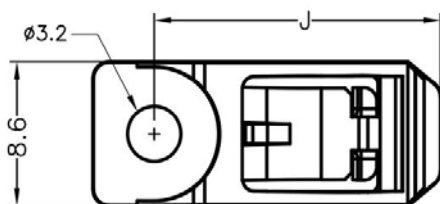
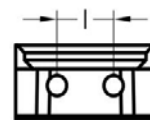
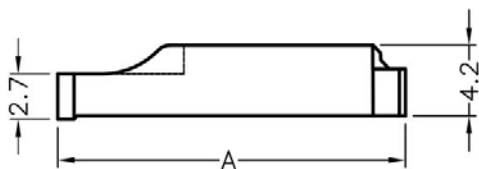

	PART NO	A	I	J	PACKAGE
	PAHO-064	22.0	3.8	18.2	1000

南京诺金电气有限公司

Nanjing Nowking Electric Co., Ltd



产品名称：零件垫座

规格型号：PAHO-065

- ◆ MATERIAL: NYLON 66 (UL)
- ◆ FLAME CLASS: 94V-0, 94V-2
- ◆ COLOR: NATURAL, BLACK
- ◆ UNIT: mm

用途：用于热敏电阻接脚之固定与保护。

PAHO-065 结构图

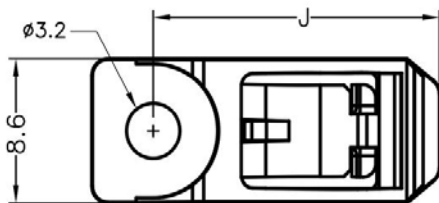
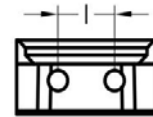
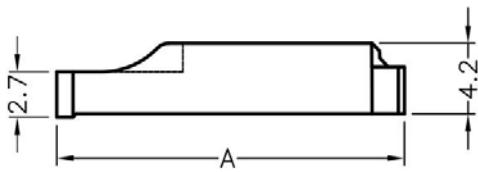

	PART NO	A	I	J	PACKAGE
	PAHO-065	21.5	3.5	17.7	1000

南京诺金电气有限公司

Nanjing Nowking Electric Co., Ltd

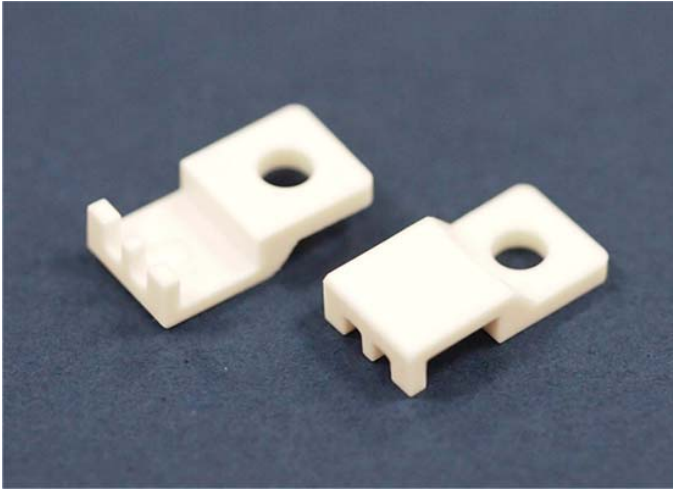

产品名称：零件垫座

规格型号：PAHO-066

- ◆ MATERIAL: PBT(UL)
- ◆ FLAME CLASS: 94V-0
- ◆ COLOR: NATURAL
- ◆ UNIT: mm

用途：用于热敏电阻接脚之固定与保护。

PAHO-066 结构图

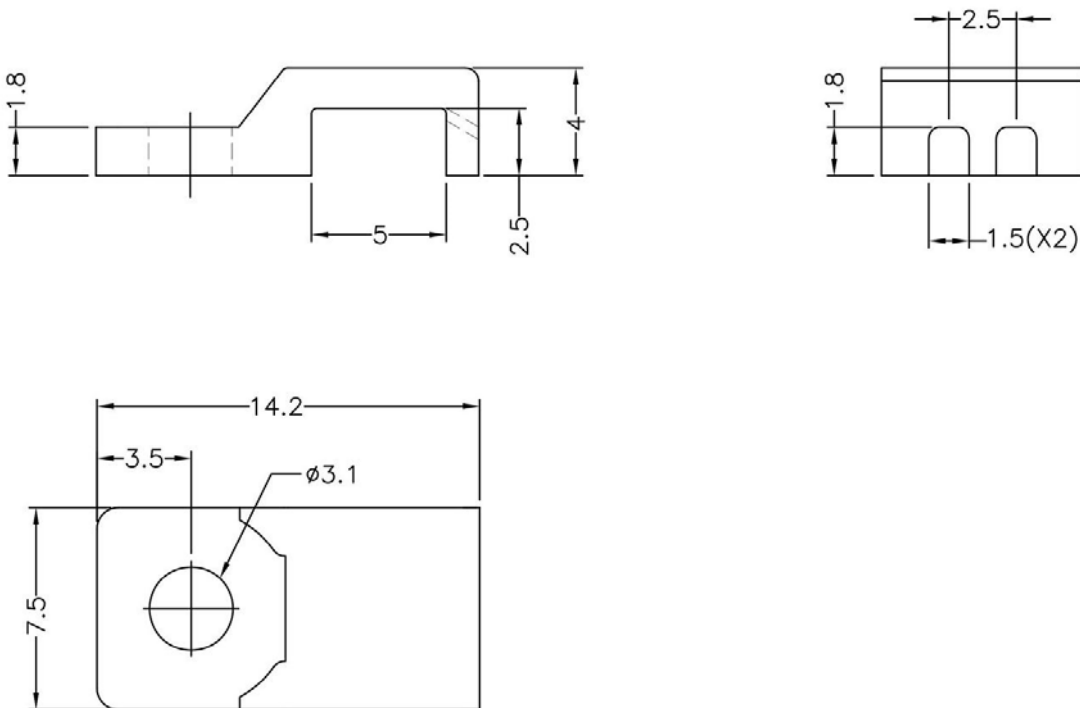

	PART NO	PACKAGE
	PAHO-066	1000

