

南京诺金电气有限公司

Nanjing Nowking Electric Co., Ltd

接地片样本



产品名称：接地片

规格型号：GNT E-1

◆MATERIAL:NICKEL PLATED
BRONZE

◆UNIT: mm

用途：用于电子、电脑仪器接地端点,一端焊于接地线,另一端用螺丝锁于机壳。

GNT E-1 结构图

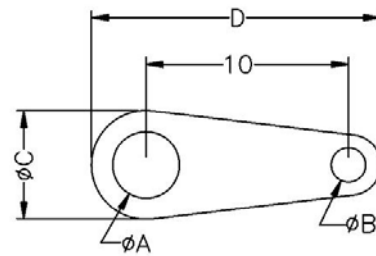

	PART NO	A	B	C	D	PACKAGE
	GNT E-1	3.2	1.6	5.5	14.3	2000

南京诺金电气有限公司

Nanjing Nowking Electric Co., Ltd



产品名称：接地片

规格型号：GNT E-2

◆MATERIAL:NICKEL PLATED
BRONZE

◆UNIT: mm

用途：用于电子、电脑仪器接地端点,一端焊于接地线,另一端用螺丝锁于机壳。

GNT E-2 结构图

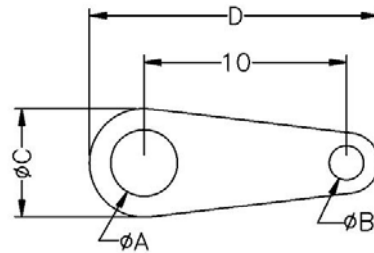

	PART NO	A	B	C	D	PACKAGE
	GNT E-2	4.1	2.4	6.5	15.5	2000

南京诺金电气有限公司

Nanjing Nowking Electric Co., Ltd

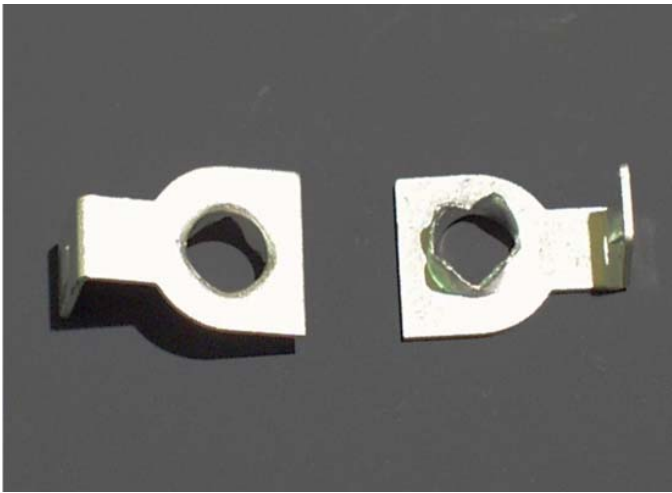

产品名称: 接地片

规格型号: GNT E-3

◆ MATERIAL: TIN PLATED BRASS

◆ UNIT: mm

用途: 用于电子、电脑仪器接地端点, 一端焊于 PC 板上, 再用螺丝固定, 接地效果佳。

GNT E-3 结构图

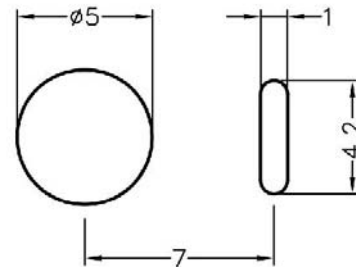
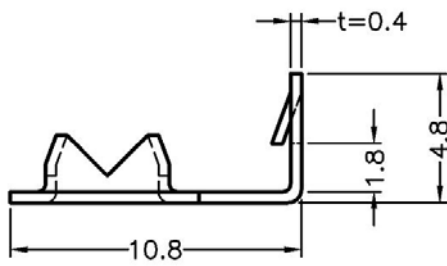

HOLE IN P.C.B

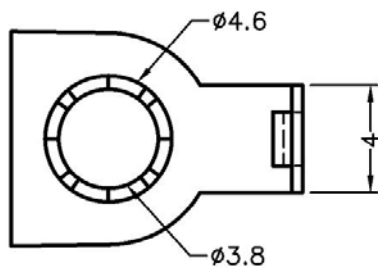

	PART NO	PACKAGE
	GNT E-3	2000

南京诺金电气有限公司

Nanjing Nowking Electric Co., Ltd



产品名称: 接地片

规格型号: GNTe-4

◆MATERIAL:TIN PLATED BRASS

◆UNIT: mm

用途: 用于电子、电脑仪器接地端点, 一端焊于PC板上, 再用螺丝固定, 接地效果佳。

GNTe-4 结构图

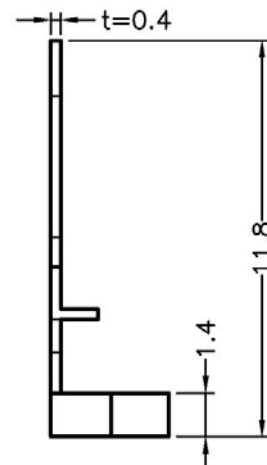
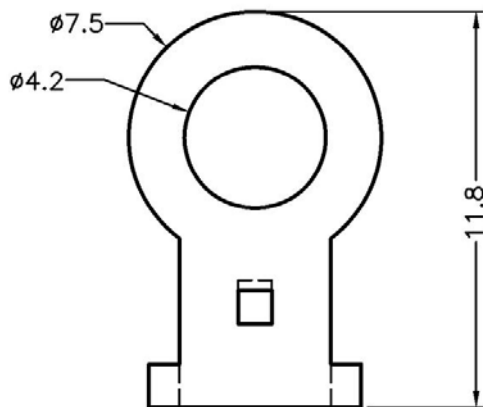
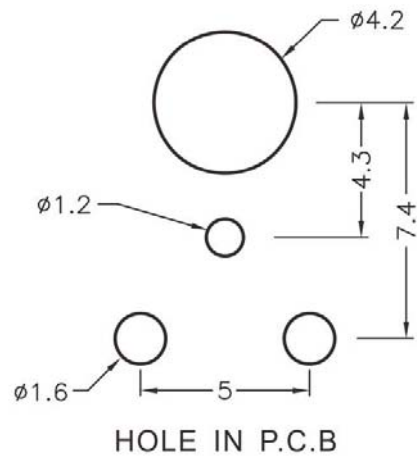
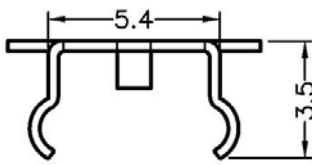

	PART NO	PACKAGE
	GNTe-4	1000

南京诺金电气有限公司

Nanjing Nowking Electric Co., Ltd



产品名称: 接地片

规格型号: GNT E-5

◆ MATERIAL: TIN PLATED BRASS

◆ UNIT: mm

用途: 用于电子、电脑仪器接地端点, 一端焊于 PC 板上, 再用螺丝固定, 接地效果佳。

GNT E-5 结构图

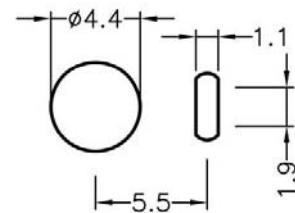
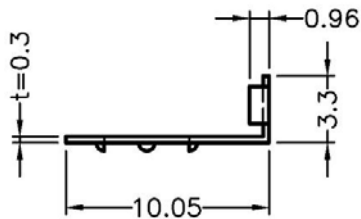

HOLE IN P.C.B

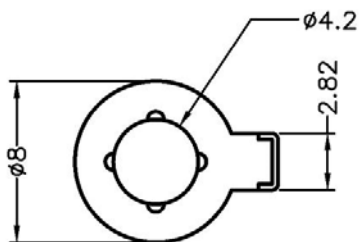

	PART NO	PACKAGE
	GNT E-5	1000

南京诺金电气有限公司

Nanjing Nowking Electric Co., Ltd



产品名称: 接地片

规格型号: GNT E-6

◆ MATERIAL: TIN PLATED BRASS

◆ UNIT: mm

用途: 用于电子、电脑仪器接地端点, 一端焊于 PC 板上, 再用螺丝固定, 接地效果佳。

GNT E-6 结构图

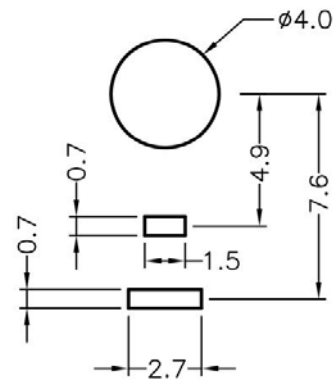
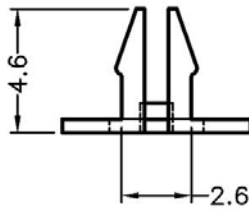

HOLE IN P.C.B

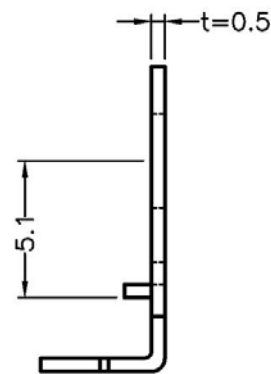
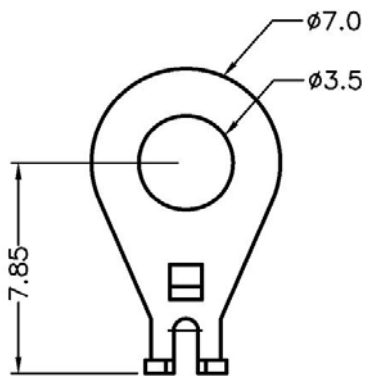

	PART NO	PACKAGE
	GNT E-6	2000

南京诺金电气有限公司

Nanjing Nowking Electric Co., Ltd



产品名称: 接地片

规格型号: GNT E-7

◆ MATERIAL: PHOSPHOR BRONZE
TIN PLATED

◆ UNIT: mm

用途: 用于电子、电脑仪器接地端点, 一端焊于 PC 板上, 再用螺丝固定, 接地效果佳。

GNT E-7 结构图

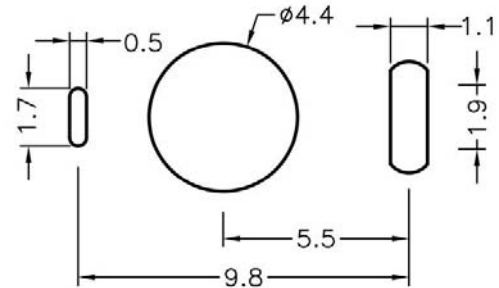
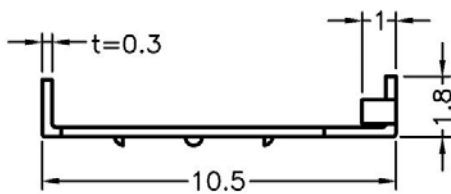

HOLE IN P.C.B

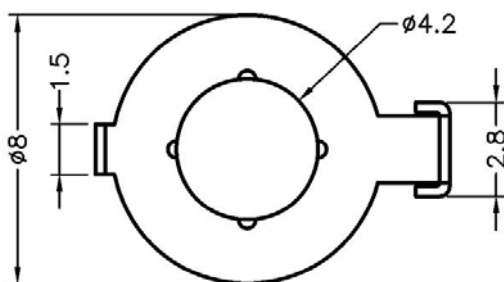

	PART NO	PACKAGE
	GNT E-7	1000

南京诺金电气有限公司

Nanjing Nowking Electric Co., Ltd



产品名称：接地片

规格型号：GNT E-8

◆MATERIAL:NICKEL PLATED BRASS

◆UNIT: mm

用途：用于电子、电脑仪器接地端点,一端焊于接地线,另一端用螺丝锁于机壳。

GNT E-8 结构图

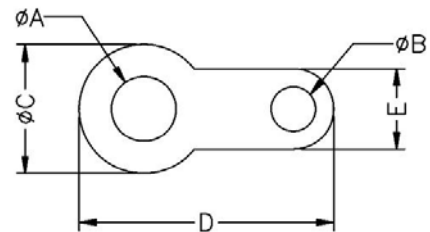

PART NO	A	B	C	D	E	F	PACKAGE
GNT E-8	3.2	2.1	6.4	12.6	4.0	0.25	2000

南京诺金电气有限公司

Nanjing Nowking Electric Co., Ltd



产品名称：接地片

规格型号：GNT E-9

◆MATERIAL:NICKEL PLATED BRASS

◆UNIT: mm

用途：用于电子、电脑仪器接地端点,一端焊于接地线,另一端用螺丝锁于机壳。

GNT E-9 结构图

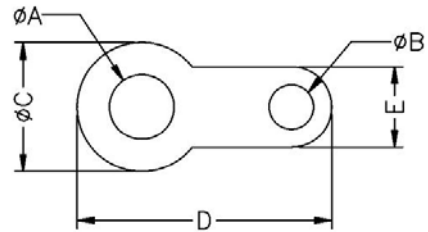

	PART NO	A	B	C	D	E	F	PACKAGE
	GNT E-9	4.3	2.0	8.0	17.7	4.6	0.3	2000

南京诺金电气有限公司

Nanjing Nowking Electric Co., Ltd



产品名称：接地片

规格型号：GNTE-10

◆MATERIAL:NICKEL PLATED BRASS

◆UNIT: mm

用途：用于电子、电脑仪器接地端点,一端焊于接地线,另一端用螺丝锁于机壳。

GNTE-10 结构图

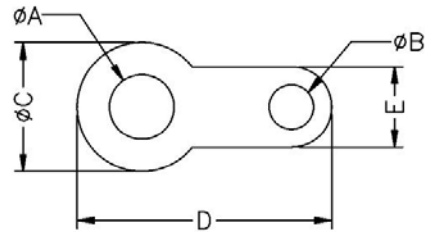

	PART NO	A	B	C	D	E	F	PACKAGE
	GNTE-10	5.2	2.1	9.9	19.6	5.1	0.3	1000

南京诺金电气有限公司

Nanjing Nowking Electric Co., Ltd



产品名称：接地片

规格型号：GNTE-11

◆MATERIAL:NICKEL PLATED BRASS

◆UNIT: mm

用途：用于电子、电脑仪器接地端点,一端焊于接地线,另一端用螺丝锁于机壳。

GNTE-11 结构图

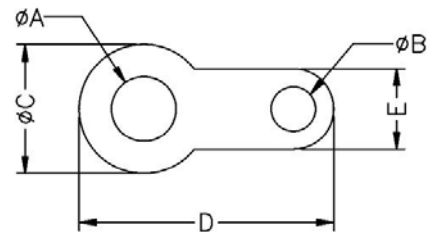

	PART NO	A	B	C	D	E	F	PACKAGE
	GNTE-11	8.3	1.9	10.0	15.0	4.0	0.3	1000

南京诺金电气有限公司

Nanjing Nowking Electric Co., Ltd



产品名称：接地片

规格型号：GNTE-12

◆MATERIAL:NICKEL PLATED BRASS

◆UNIT: mm

用途：用于电子、电脑仪器接地端点,一端焊于接地线,另一端用螺丝锁于机壳。

GNTE-12 结构图

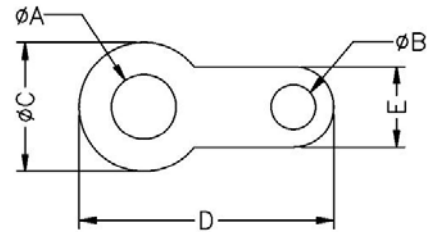

	PART NO	A	B	C	D	E	F	PACKAGE
	GNTE-12	9.7	2.0	13.0	21.5	4.0	0.4	1000

南京诺金电气有限公司

Nanjing Nowking Electric Co., Ltd



产品名称：接地片

规格型号：GNTE-13

◆MATERIAL:NICKEL PLATED BRASS

◆UNIT: mm

用途：用于电子、电脑仪器接地端点,一端焊于接地线,另一端用螺丝锁于机壳。

GNTE-13 结构图

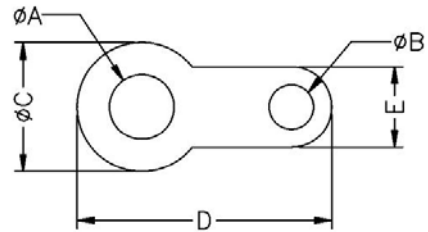

	PART NO	A	B	C	D	E	F	PACKAGE
	GNTE-13	6.3	2.1	10.0	19.9	5.1	0.3	2000

南京诺金电气有限公司

Nanjing Nowking Electric Co., Ltd



产品名称：接地片

规格型号：GNTTE-14

◆MATERIAL:NICKEL PLATED BRASS

◆UNIT: mm

用途：用于电子、电脑仪器接地端点,一端焊于接地线,另一端用螺丝锁于机壳。

GNTTE-14 结构图

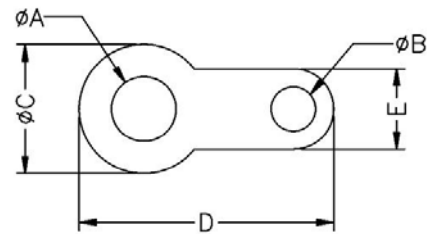

	PART NO	A	B	C	D	E	F	PACKAGE
	GNTTE-14	9.0	2.0	13.0	30.0	4.0	0.3	1000

南京诺金电气有限公司

Nanjing Nowking Electric Co., Ltd



产品名称：接地片

规格型号：GNTE-15

◆MATERIAL:NICKEL PLATED BRASS

◆UNIT: mm

用途：用于电子、电脑仪器接地端点,一端焊于接地线,另一端用螺丝锁于机壳。

GNTE-15 结构图

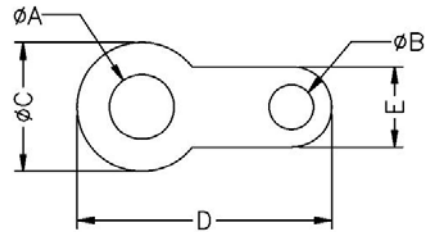

	PART NO	A	B	C	D	E	F	PACKAGE
	GNTE-15	4.2	1.6	6.8	12.9	3.2	0.4	2000

南京诺金电气有限公司

Nanjing Nowking Electric Co., Ltd



产品名称：接地片

规格型号：GNTE-16

◆MATERIAL:NICKEL PLATED BRASS

◆UNIT: mm

用途：用于电子、电脑仪器接地端点,一端焊于接地线,另一端用螺丝锁于机壳。

GNTE-16 结构图

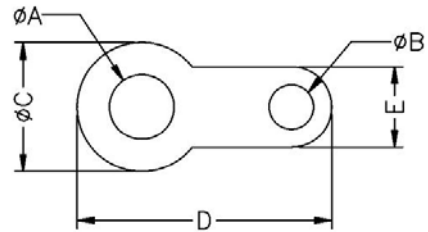

	PART NO	A	B	C	D	E	F	PACKAGE
	GNTE-16	3.7	1.6	6.3	12.6	3.2	0.4	2000

南京诺金电气有限公司

Nanjing Nowking Electric Co., Ltd



产品名称：接地片

规格型号：GNTE-17

◆MATERIAL:NICKEL PLATED BRASS

◆UNIT: mm

用途：用于电子、电脑仪器接地端点,一端焊于接地线,另一端用螺丝锁于机壳。

GNTE-17 结构图

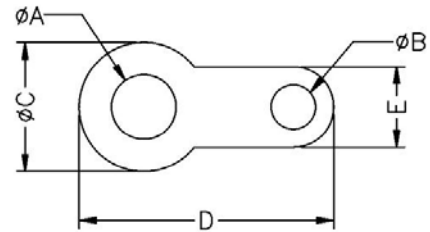

PART NO	A	B	C	D	E	F	PACKAGE
GNTE-17	3.2	1.5	4.5	12.6	3.0	0.25	2000

南京诺金电气有限公司

Nanjing Nowking Electric Co., Ltd



产品名称：接地片

规格型号：GNTE-18

◆MATERIAL:NICKEL PLATED BRASS

◆UNIT: mm

用途：用于电子、电脑仪器接地端点,一端焊于接地线,另一端用螺丝锁于机壳。

GNTE-18 结构图

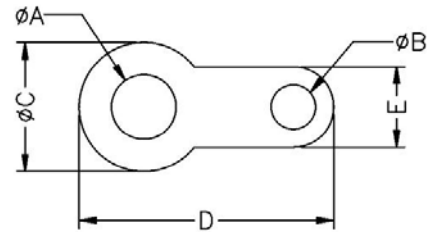

	PART NO	A	B	C	D	E	F	PACKAGE
	GNTE-18	2.2	1.5	4.5	12.6	3.0	0.25	2000

南京诺金电气有限公司

Nanjing Nowking Electric Co., Ltd



产品名称: 接地片

规格型号: GNTTE-19

◆MATERIAL:PHOSPHOR BRONZE
NICKEL PLATED

◆UNIT: mm

用途: 用于电子、电脑仪器接地端点, 一端焊于PC板上, 再用螺丝固定, 接地效果佳。

GNTTE-19 结构图

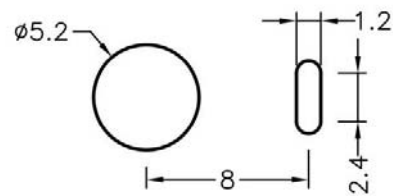

HOLE IN P.C.B

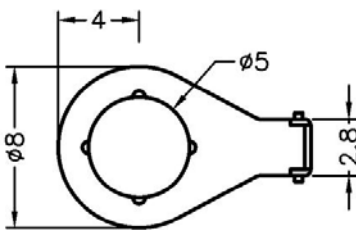

	PART NO	PACKAGE
	GNTTE-19	2000

南京诺金电气有限公司

Nanjing Nowking Electric Co., Ltd



产品名称: 接地片

规格型号: GNT E-20

◆MATERIAL:TIN PLATED BRASS

◆UNIT: mm

用途: 用于电子、电脑仪器接地端点, 一端焊于PC板上, 再用螺丝固定, 接地效果佳。

GNT E-20 结构图

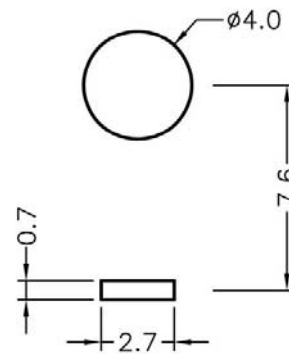
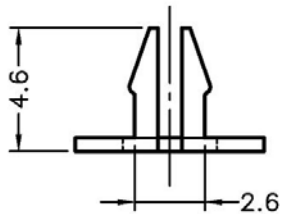

HOLE IN P.C.B

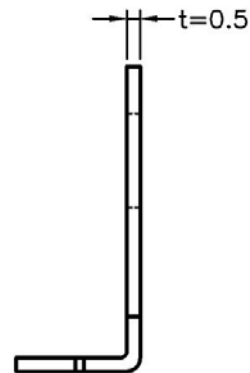
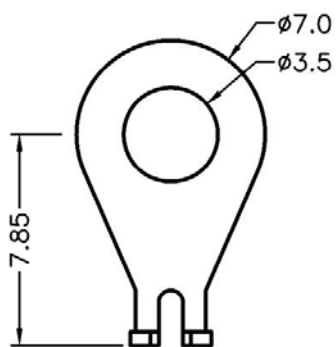

	PART NO	PACKAGE
	GNT E-20	2000

南京诺金电气有限公司

Nanjing Nowking Electric Co., Ltd



产品名称: 接地片

规格型号: GNT E-21

◆ MATERIAL: TIN PLATED BRASS

◆ UNIT: mm

用途: 用于电子、电脑仪器接地端点,一端焊于接地线,另一端用螺丝锁于机壳。

GNT E-21 结构图

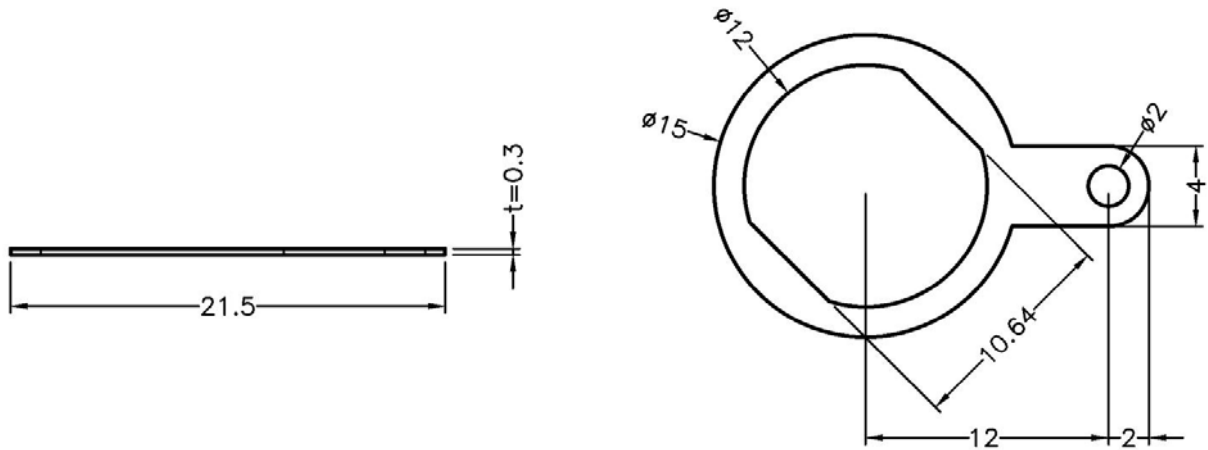

	PART NO	PACKAGE
	GNT E-21	1000

南京诺金电气有限公司

Nanjing Nowking Electric Co., Ltd



产品名称: 接地片

规格型号: GNTE-22

◆MATERIAL:NICKEL PLATED BRASS

◆UNIT: mm

用途: 用于电子、电脑仪器接地端点, 一端焊于PC板上, 再用螺丝固定, 接地效果佳。

GNTE-22 结构图

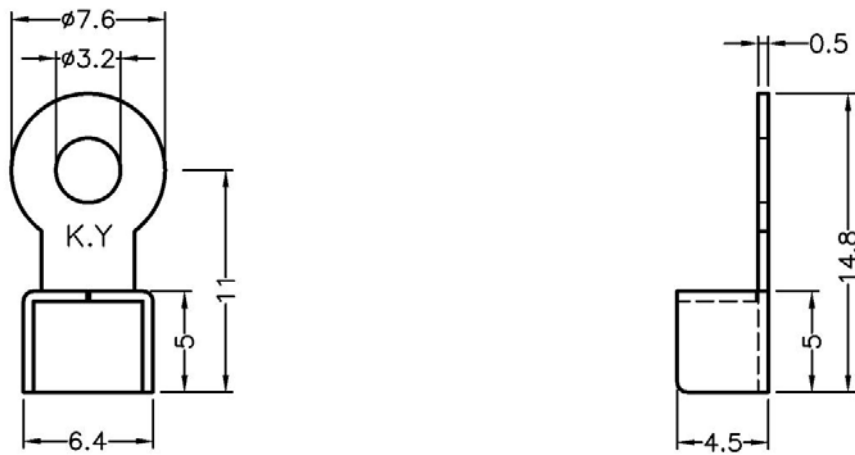

	PART NO	PACKAGE
	GNTE-22	1000

南京诺金电气有限公司

Nanjing Nowking Electric Co., Ltd



产品名称: 接地片

规格型号: GNT E-23

◆MATERIAL:SPTE,TIN PLATED
BRASS

◆UNIT: mm

用途: 用于电子、电脑仪器接地端点, 一端焊于PC板上, 再用螺丝固定, 接地效果佳。

GNT E-23 结构图

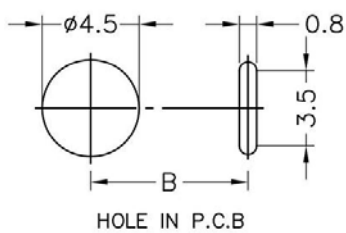
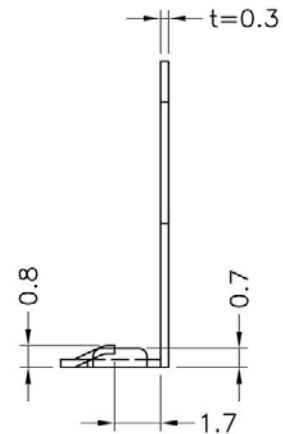
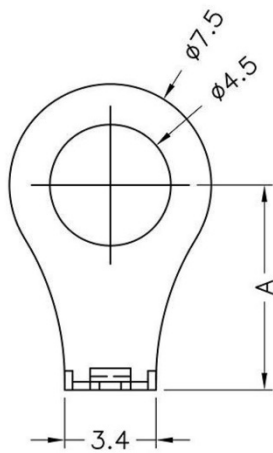

PART NO	A	PACKAGE
GNT E-23	7.9	1000

总机/TEL:+86 25 85437901 85422485 85436028
[Http://www.nowking.com](http://www.nowking.com) E-mail: nk@nowking.com
 QQ: 260678075 WeChat:13770725488

南京诺金电气有限公司

Nanjing Nowking Electric Co., Ltd



产品名称: 接地片

规格型号: GNT E-24

◆MATERIAL:SPTE,TIN PLATED
BRASS

◆UNIT: mm

用途: 用于电子、电脑仪器接地端点, 一端
焊于PC板上, 再用螺丝固定, 接地效果
佳。

GNT E-24 结构图

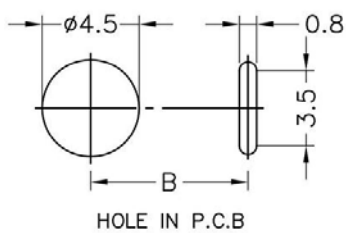
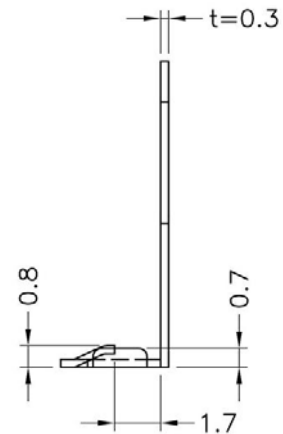
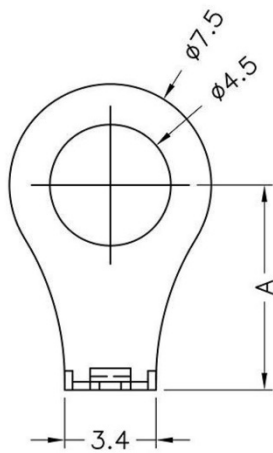

PART NO	A	PACKAGE
GNT E-24	7.6	1000

总机/TEL:+86 25 85437901 85422485 85436028
[Http://www.nowking.com](http://www.nowking.com) E-mail: nk@nowking.com
 QQ: 260678075 WeChat:13770725488

南京诺金电气有限公司

Nanjing Nowking Electric Co., Ltd

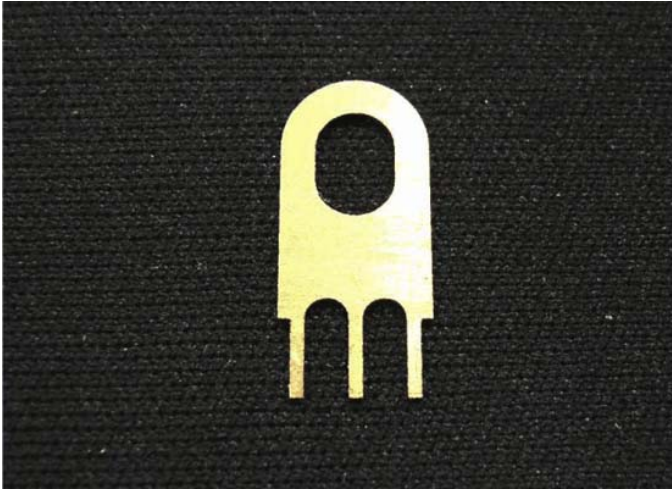

产品名称：接地片

规格型号：GNT E-25

◆MATERIAL:TIN PLATED BRASS

◆UNIT: mm

用途：用于电子、电脑仪器接地端点,一端焊于接地线,另一端用螺丝锁于机壳。

GNT E-25 结构图

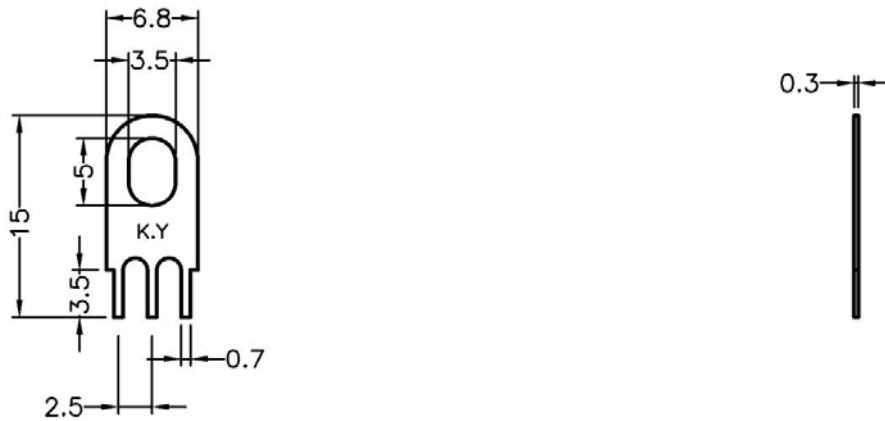

	PART NO	PACKAGE
	GNT E-25	1000

南京诺金电气有限公司

Nanjing Nowking Electric Co., Ltd



产品名称: 接地片

规格型号: GNTTE-26

◆MATERIAL:TIN PLATED BRASS

◆UNIT: mm

用途: 用于电子、电脑仪器接地端点, 一端焊于PC板上, 再用螺丝固定, 接地效果佳。

GNTTE-26 结构图

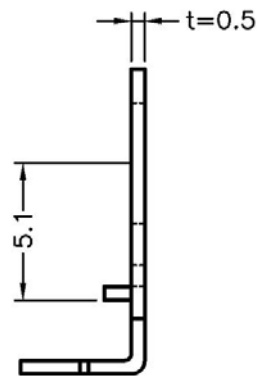
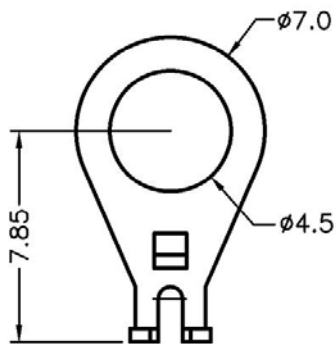
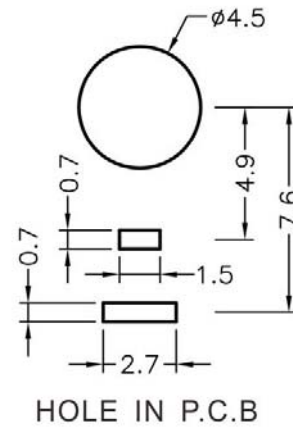
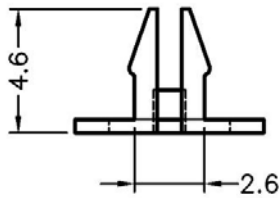

	PART NO	PACKAGE
	GNTTE-26	2000

南京诺金电气有限公司

Nanjing Nowking Electric Co., Ltd



产品名称: 接地片

规格型号: GNTTE-27

◆MATERIAL:NICKEL PLATED BRASS

◆UNIT: mm

用途: 用于电子、电脑仪器接地端点, 一端焊于PC板上, 再用螺丝固定, 接地效果佳。

GNTTE-27 结构图

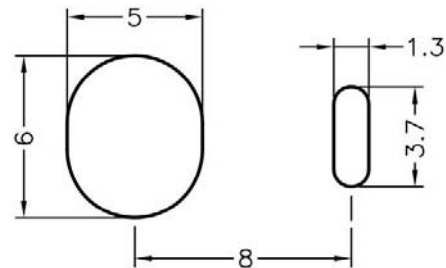
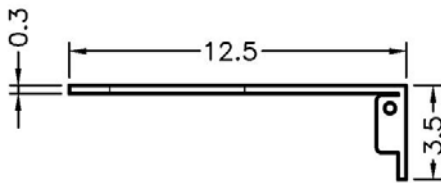

HOLE IN P.C.B

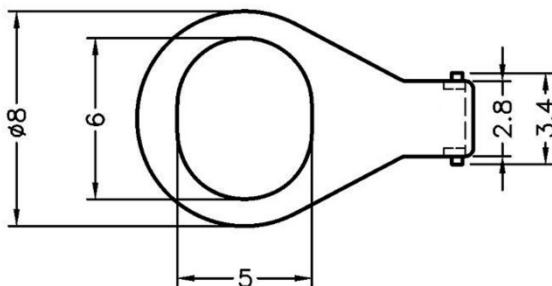

	PART NO	PACKAGE
	GNTTE-27	1000

南京诺金电气有限公司

Nanjing Nowking Electric Co., Ltd



产品名称: 接地片

规格型号: GNT E-28

◆ MATERIAL: NICKEL PLATED BRASS

◆ UNIT: mm

用途: 用于电子、电脑仪器接地端点, 一端焊于 PC 板上, 再用螺丝固定, 接地效果佳。

GNT E-28 结构图

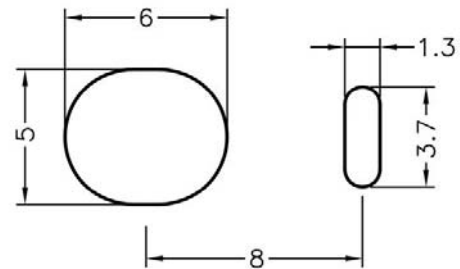
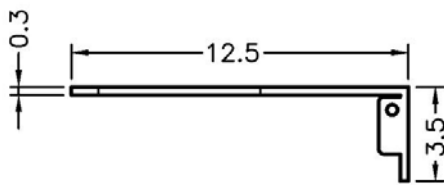

HOLE IN P.C.B

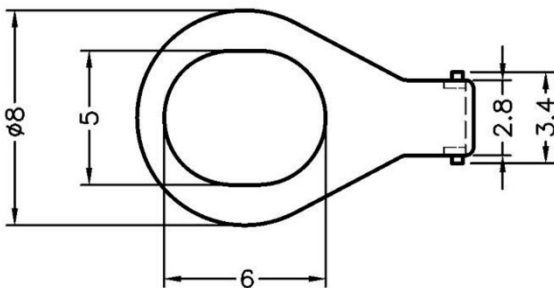

	PART NO	PACKAGE
	GNT E-28	1000

南京诺金电气有限公司

Nanjing Nowking Electric Co., Ltd



产品名称: 接地片

规格型号: GNT E-29

◆ MATERIAL: TIN PLATED BRASS

◆ UNIT: mm

用途: 用于电子、电脑仪器接地端点, 一端焊于 PC 板上, 再用螺丝固定, 接地效果佳。

GNT E-29 结构图

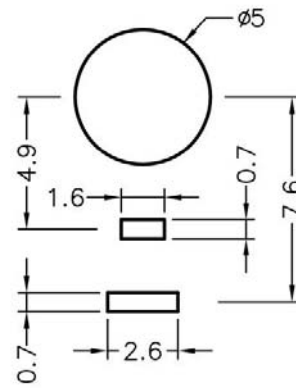
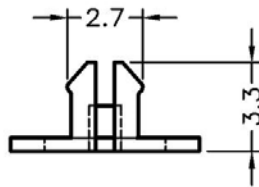

HOLE IN P.C.B

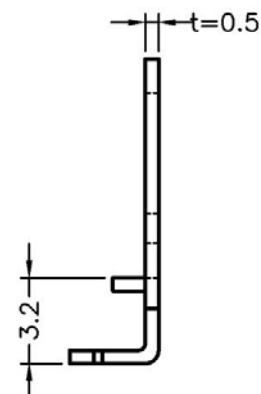
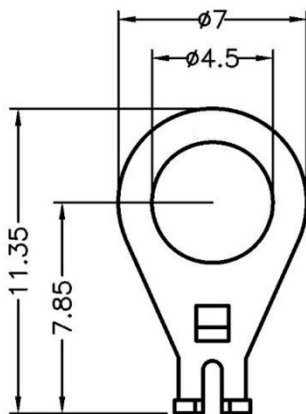

	PART NO	PACKAGE
	GNT E-29	1000

南京诺金电气有限公司

Nanjing Nowking Electric Co., Ltd



产品名称：接地片

规格型号：GNT E-30

◆MATERIAL:PHOSPHOR BRONZE
TIN PLATED/磷青铜镀锡

◆UNIT: mm

用途：用于电子、电脑仪器接地端点，一端焊于PC板上，再用螺丝固定，接地效果佳。

GNT E-30 结构图

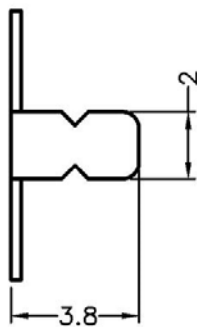
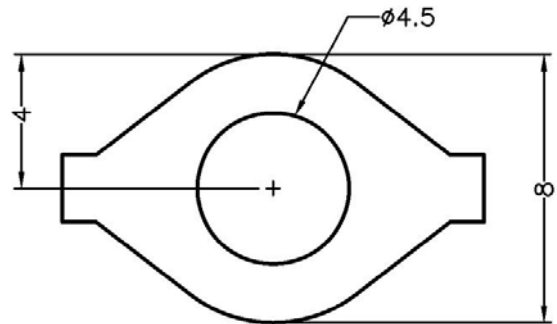
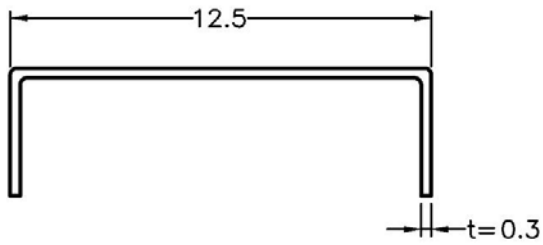

	PART NO	PACKAGE
	GNT E-30	1000

总机/TEL:+86 25 85437901 85422485 85436028
[Http://www.nowking.com](http://www.nowking.com) E-mail: nk@nowking.com
 QQ: 260678075 WeChat:13770725488

南京诺金电气有限公司

Nanjing Nowking Electric Co., Ltd



产品名称: 接地片

规格型号: GNT E-31

◆ MATERIAL: TIN PLATED SPCC

◆ UNIT: mm

用途: 用于电子、电脑仪器接地端点, 一端焊于 PC 板上, 再用螺丝固定, 接地效果佳。

GNT E-31 结构图

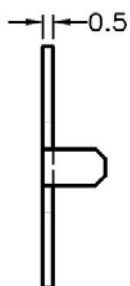
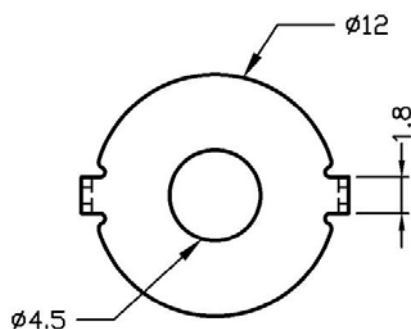
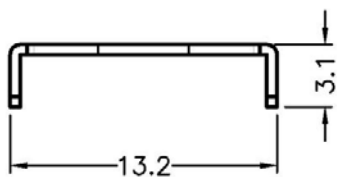

	PART NO	PACKAGE
	GNT E-31	1000

总机/TEL: +86 25 85437901 85422485 85436028
[Http://www.nowking.com](http://www.nowking.com) E-mail: nk@nowking.com
QQ: 260678075 WeChat: 13770725488

南京诺金电气有限公司

Nanjing Nowking Electric Co., Ltd



产品名称: 接地片

规格型号: GNT E-32

◆ MATERIAL: PHOSPHOR BRONZE
TIN PLATED

◆ UNIT: mm

用途: 用于电子、电脑仪器接地端点, 一端焊于 PC 板上, 再用螺丝固定, 接地效果佳。

GNT E-32 结构图

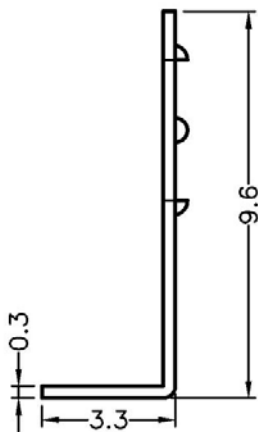
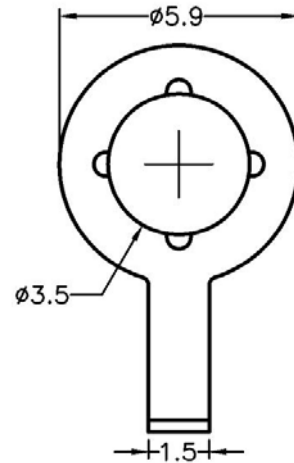
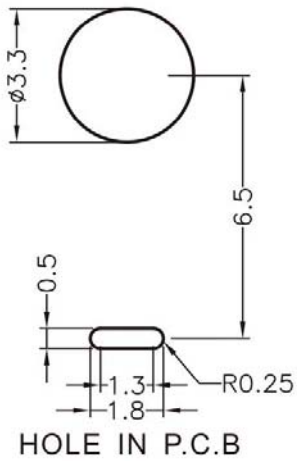

	PART NO	PACKAGE
	GNT E-32	1000

南京诺金电气有限公司

Nanjing Nowking Electric Co., Ltd



产品名称: 接地片

规格型号: GNT E-33

◆ MATERIAL: PHOSPHOR BRONZE
NICKEL PLATED

◆ UNIT: mm

用途: 用于电子、电脑仪器接地端点, 一端焊于 PC 板上, 再用螺丝固定, 接地效果佳。

GNT E-33 结构图

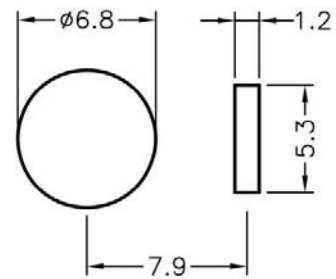
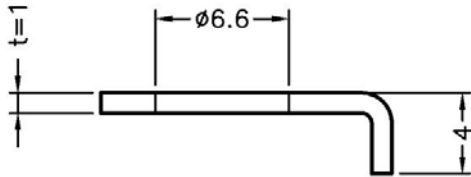

HOLE IN P.C.B

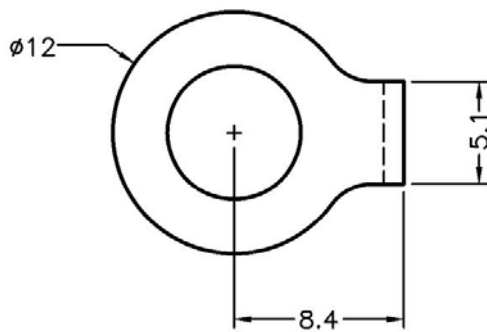

	PART NO	PACKAGE
	GNT E-33	1000

南京诺金电气有限公司

Nanjing Nowking Electric Co., Ltd



产品名称: 接地片

规格型号: GNT E-34

◆ MATERIAL: TIN PLATED BRASS

◆ UNIT: mm

用途: 用于电子、电脑仪器接地端点, 一端焊于 PC 板上, 再用螺丝固定, 接地效果佳。

GNT E-34 结构图

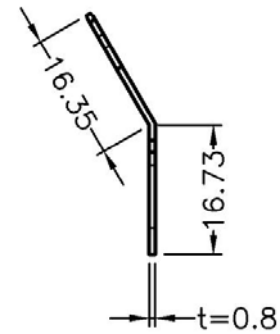
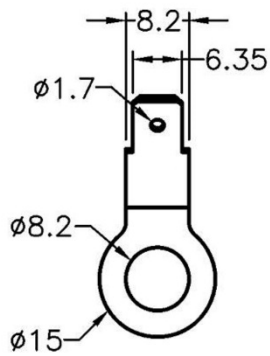

	PART NO	PACKAGE
	GNT E-34	1000

南京诺金电气有限公司

Nanjing Nowking Electric Co., Ltd



产品名称: 接地片

规格型号: GNT E-35

◆MATERIAL: NICKEL PLATED
BRASS

◆UNIT: mm

用途: 用于电子、电脑仪器接地端点, 一端
焊于 PC 板上, 再用螺丝固定, 接地效果
佳。

GNT E-35 结构图

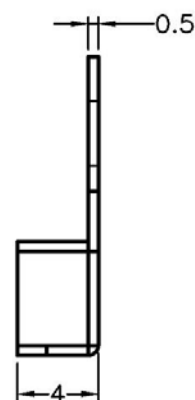
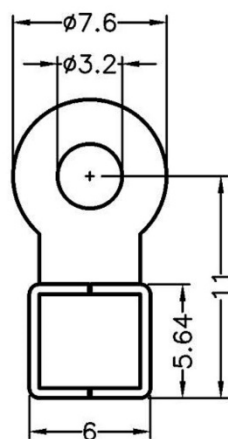

	PART NO	PACKAGE
	GNT E-35	1000

南京诺金电气有限公司

Nanjing Nowking Electric Co., Ltd



产品名称: 接地片

规格型号: GNT E-36

◆ MATERIAL: TIN PLATED BRASS

◆ UNIT: mm

用途: 用于电子、电脑仪器接地端点, 一端焊于 PC 板上, 再用螺丝固定, 接地效果佳。

GNT E-36 结构图

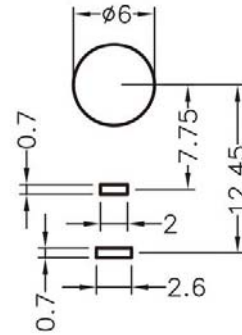
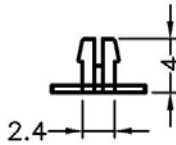

HOLE IN P.C.B

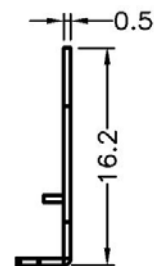
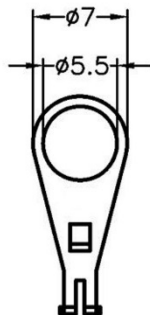

	PART NO	PACKAGE
	GNT E-36	1000

南京诺金电气有限公司

Nanjing Nowking Electric Co., Ltd



产品名称：接地片

规格型号：GNT E-37

◆MATERIAL: TIN PLATED BRASS

◆UNIT: mm

用途：用于电子、电脑仪器接地端点，一端焊于PC板上，再用螺丝固定，接地效果佳。

GNT E-37 结构图

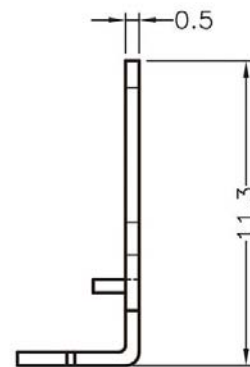
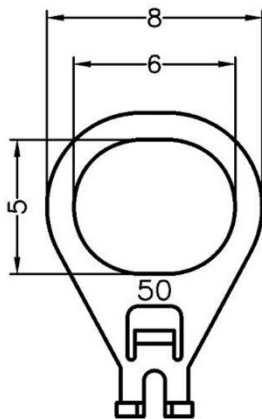
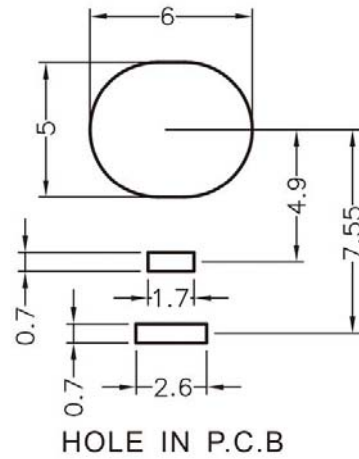
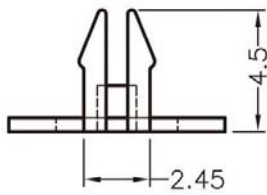

	PART NO	PACKAGE
	GNT E-37	1000

南京诺金电气有限公司

Nanjing Nowking Electric Co., Ltd



产品名称: 接地片

规格型号: GNT E-38

◆MATERIAL: PHOSPHOR BRONZE WITH NICKEL PLATED

◆UNIT: mm

用途: 用于电子、电脑仪器接地端点, 一端焊于 PC 板上, 再用螺丝固定, 接地效果佳。

GNT E-38 结构图

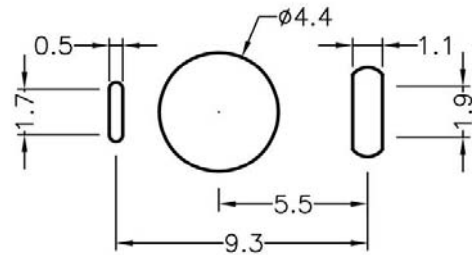
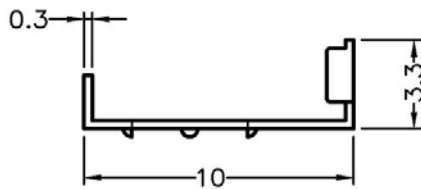

HOLE IN P.C.B

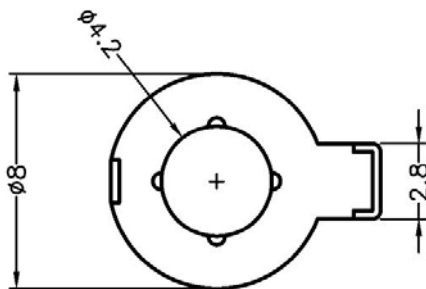

	PART NO	PACKAGE
	GNT E-38	1000

南京诺金电气有限公司

Nanjing Nowking Electric Co., Ltd



产品名称: 接地片

规格型号: GNT E-39

◆ MATERIAL 1: WITH TIN PLATED BRASS

◆ MATERIAL 2: NICKEL PLATED BRASS

◆ UNIT: mm

用途: 用于电子、电脑仪器接地端点, 一端焊于 PC 板上, 再用螺丝固定, 接地效果佳。

GNT E-39 结构图

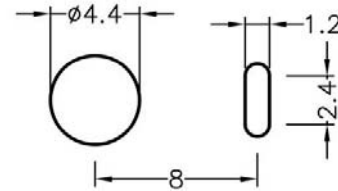
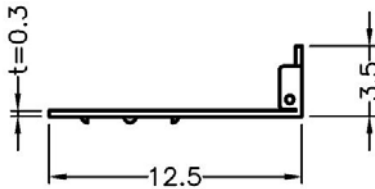

HOLE IN P.C.B

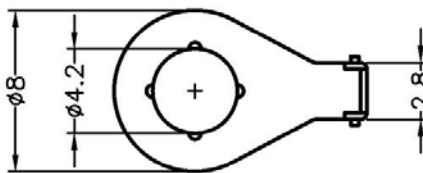

	PART NO	PACKAGE
	GNT E-39	1000

南京诺金电气有限公司

Nanjing Nowking Electric Co., Ltd



产品名称：接地片

规格型号：GNT E-40

◆MATERIAL : NICKEL PLATED
BROZE

◆UNIT: mm

用途：用于电子、电脑仪器接地端点,一端焊于接地线,另一端用螺丝锁于机壳。

GNT E-40 结构图

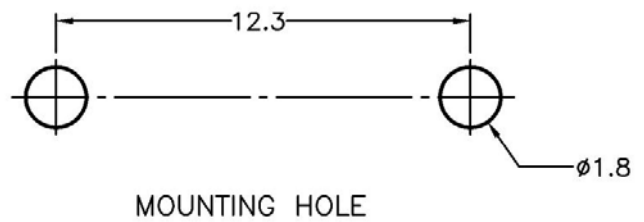
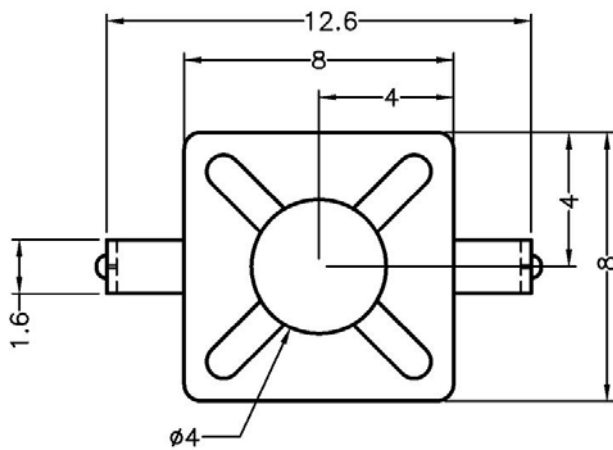
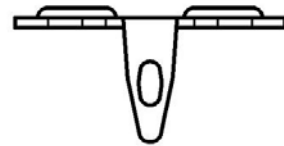
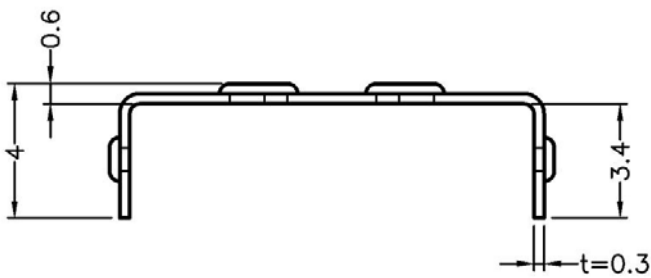

	PART NO	PACKAGE
	GNT E-40	1000

南京诺金电气有限公司

Nanjing Nowking Electric Co., Ltd

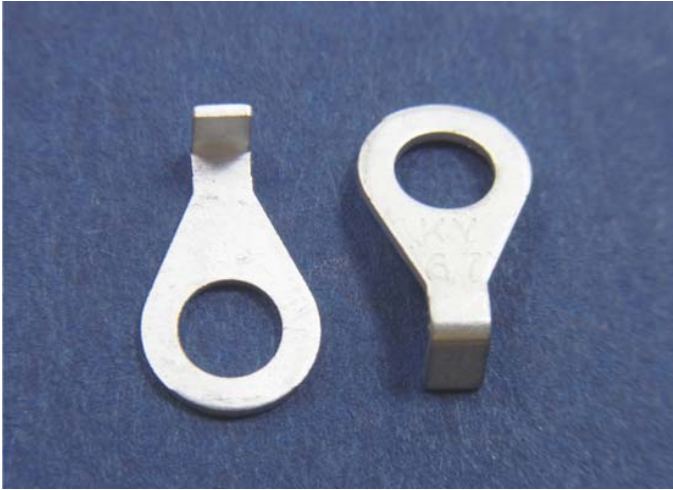

产品名称: 接地片

规格型号: GNT-41

◆MATERIAL : TIN PLATED BRASS

◆UNIT: mm

用途: 用于电子、电脑仪器接地端点, 一端焊于PC板上, 再用螺丝固定, 接地效果佳。

GNT-41 结构图

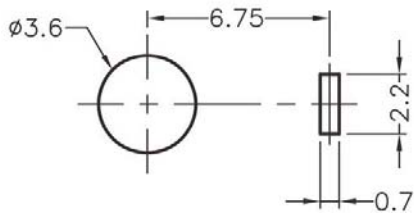

HOLE IN P.C.B

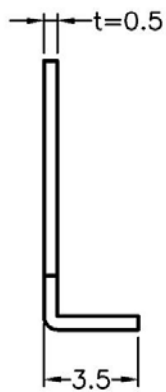
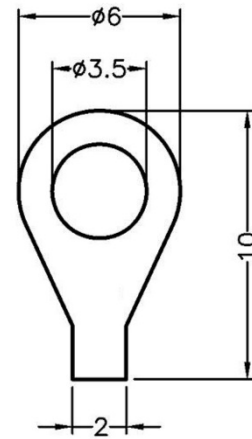

PART NO	A	B	PACKAGE
GNT-41	3.5	3.6	1000

南京诺金电气有限公司

Nanjing Nowking Electric Co., Ltd

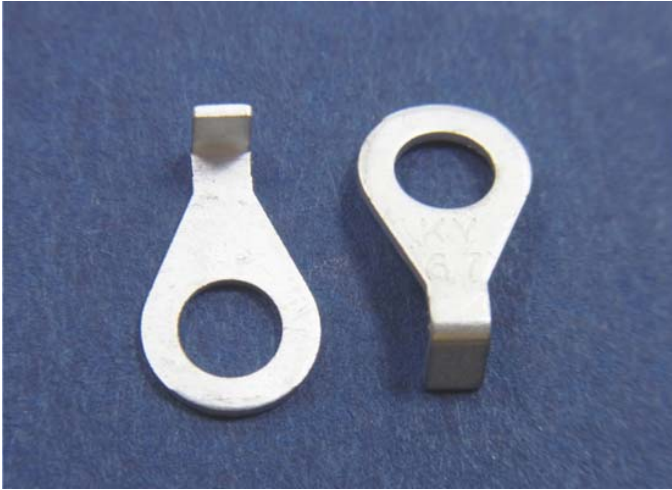

产品名称：接地片

规格型号：GNT-42

◆MATERIAL : TIN PLATED BRASS

◆UNIT: mm

用途：用于电子、电脑仪器接地端点，一端焊于PC板上，再用螺丝固定，接地效果佳。

GNT-42 结构图

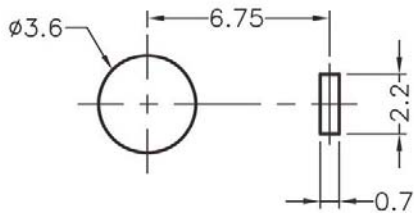

HOLE IN P.C.B

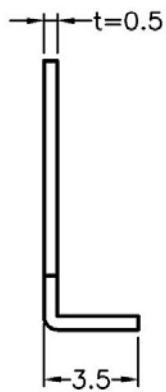
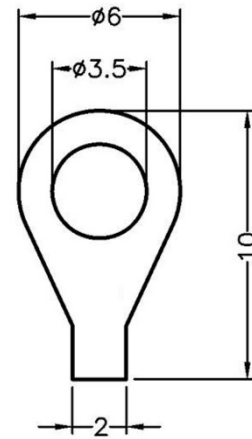

PART NO	A	B	PACKAGE
GNT-42	4.0	4.1	1000

南京诺金电气有限公司

Nanjing Nowking Electric Co., Ltd



产品名称：接地片

规格型号：GNTTE-43

◆MATERIAL : PHOSPHOR BRONZE
TIN PLATED

◆UNIT: mm

用途：用于电子、电脑仪器接地端点，一端焊于PC板上，再用螺丝固定，接地效果佳。

GNTTE-43 结构图

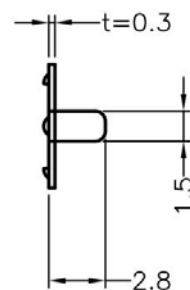
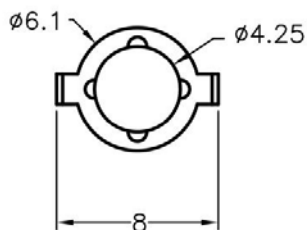
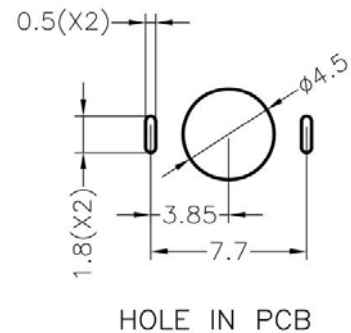
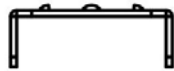

	PART NO	PACKAGE
	GNTTE-43	1000

总机/TEL:+86 25 85437901 85422485 85436028
[Http://www.nowking.com](http://www.nowking.com) E-mail: nk@nowking.com
 QQ: 260678075 WeChat:13770725488

南京诺金电气有限公司

Nanjing Nowking Electric Co., Ltd



产品名称：接地片

规格型号：GNT-44

◆MATERIAL : BRIGHT TIN PLATED BRASS

◆UNIT: mm

用途：用于电子、电脑仪器接地端点，一端焊于PC板上，再用螺丝固定，接地效果佳。

GNT-44 结构图

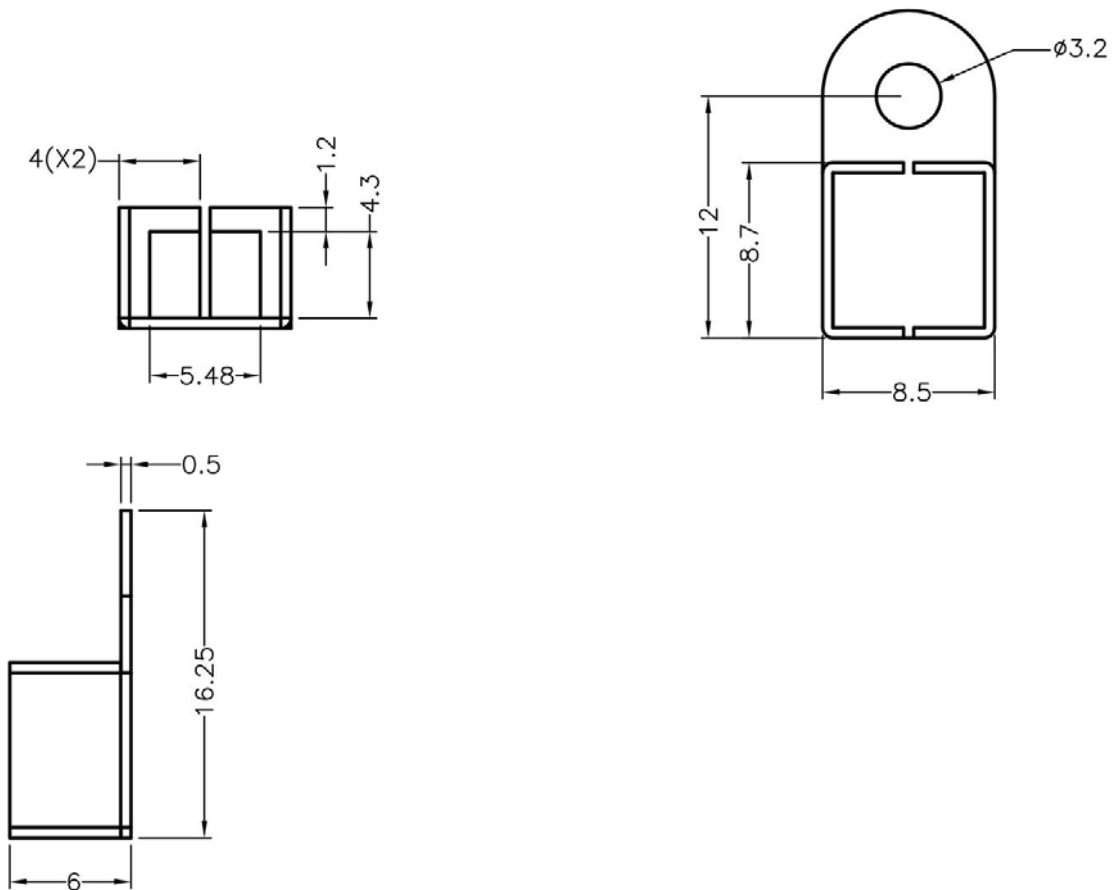

	PART NO	PACKAGE
	GNT-44	1000

总机/TEL:+86 25 85437901 85422485 85436028
[Http://www.nowking.com](http://www.nowking.com) E-mail: nk@nowking.com
 QQ: 260678075 WeChat:13770725488

南京诺金电气有限公司

Nanjing Nowking Electric Co., Ltd



产品名称：接地片

规格型号：GNT E-45

◆MATERIAL : SPCC

◆UNIT: mm

用途：用于电子、电脑仪器接地端点，一端焊于PC板上，再用螺丝固定，接地效果佳。

GNT E-45 结构图

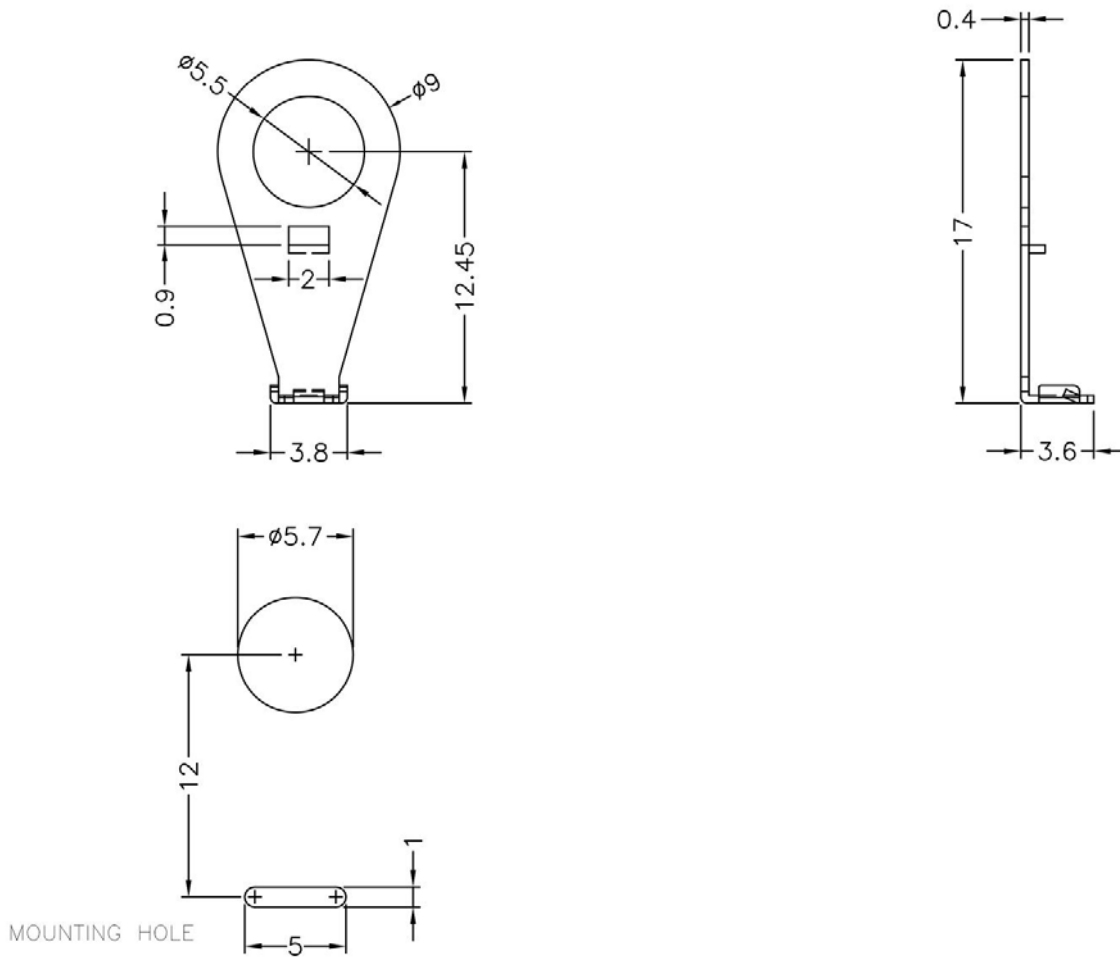

	PART NO	PACKAGE
	GNT E-45	1000

总机/TEL:+86 25 85437901 85422485 85436028
[Http://www.nowking.com](http://www.nowking.com) E-mail: nk@nowking.com
 QQ: 260678075 WeChat:13770725488

