

南京诺金电气有限公司

Nanjing Nowking Electric Co., Ltd

端子盖样本



产品名称：端子盖

规格型号：DZGR-01

◆ MATERIAL: PE

◆ COLOR: NATURAL

◆ UNIT: mm

用途：用于 F 端子之防尘与保护用。

可使用同等材质

DZGR-01 结构图

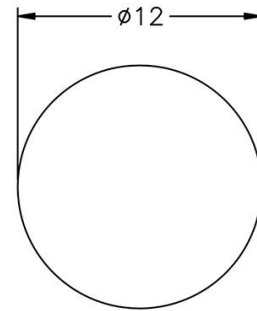
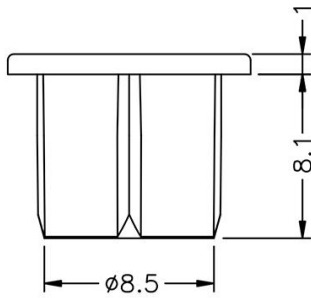

	PART NO	PACKAGE
	DZGR-01	1000

南京诺金电气有限公司

Nanjing Nowking Electric Co., Ltd



产品名称：端子盖

规格型号：DZGR-02

- ◆ MATERIAL: NYLON 66(UL)
- ◆ FLAME CLASS: 94V-0, 94V-2
- ◆ COLOR: NATURAL, BLACK
- ◆ UNIT: mm

用途：用于端子绝缘。

DZGR-02 结构图

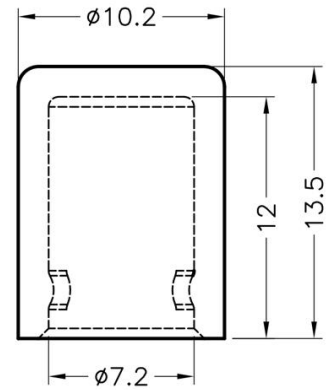
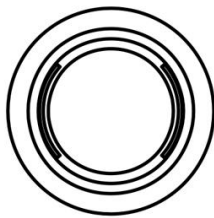

	PART NO	PACKAGE
	DZGR-02	1000

南京诺金电气有限公司

Nanjing Nowking Electric Co., Ltd

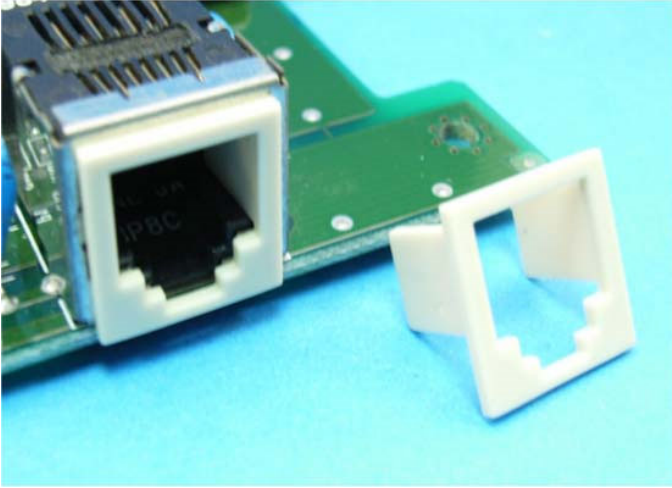

产品名称：端子盖

规格型号：DZGR-03

- ◆ MATERIAL: ABS(UL)
- ◆ FLAME CLASS:94HB
- ◆ COLOR:IVORY,BLACK
- ◆ UNIT: mm

用途: RJ45 转接 RJ11 接头。

DZGR-03 结构图

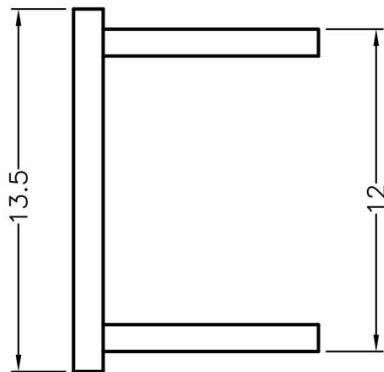
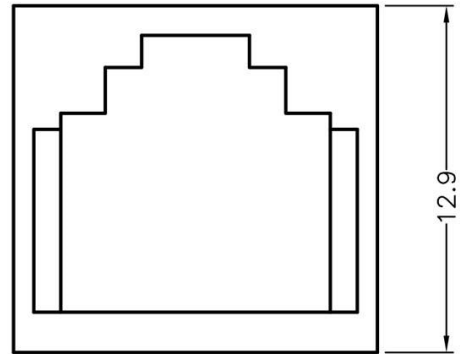
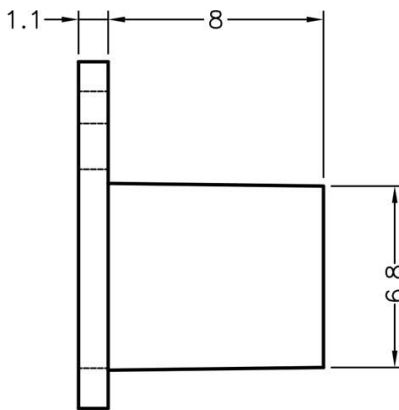

	PART NO	PACKAGE
	DZGR-03	1000

南京诺金电气有限公司

Nanjing Nowking Electric Co., Ltd

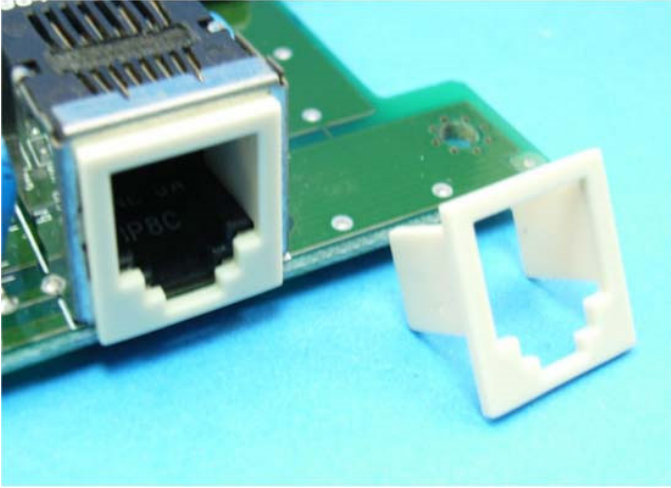

产品名称：端子盖

规格型号：DZGR-04

- ◆ MATERIAL: ABS(UL)
- ◆ FLAME CLASS:94HB
- ◆ COLOR:IVORY,BLACK
- ◆ UNIT: mm

用途：RJ45 转接 RJ11 接头。

DZGR-04 结构图

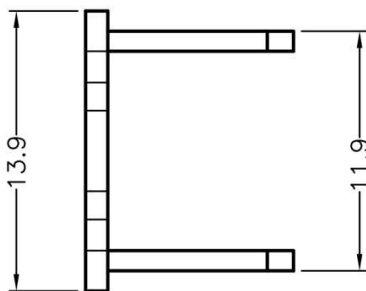
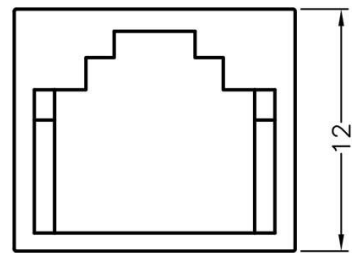
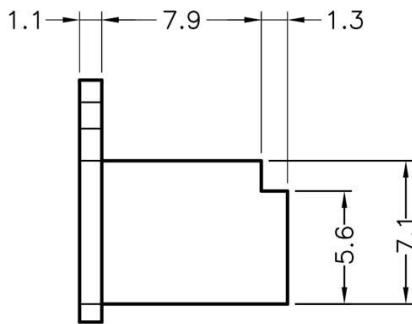

	PART NO	PACKAGE
	DZGR-04	1000

南京诺金电气有限公司

Nanjing Nowking Electric Co., Ltd



产品名称：端子盖

规格型号：DZGR-05

◆ MATERIAL: PE

◆ COLOR: BLACK

◆ UNIT: mm

用途：用于 RCA 端子防尘与保护。

DZGR-05 结构图

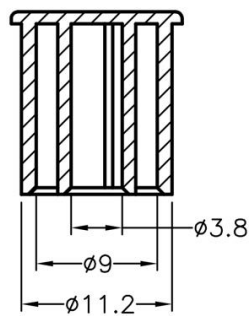
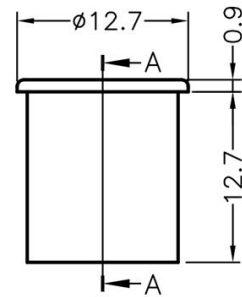
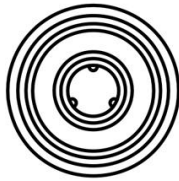

SECTION A-A

	PART NO	PACKAGE
	DZGR-05	1000

南京诺金电气有限公司

Nanjing Nowking Electric Co., Ltd



产品名称：端子盖

规格型号：DZGR-06

◆ MATERIAL: PE

◆ COLOR: BLACK, NATURAL

◆ UNIT: mm

用途：用于 F 端子之防尘与保护用。

所有尺寸量测皆不含进胶口,胶口凸出 0.3mm 之内

DZGR-06 结构图

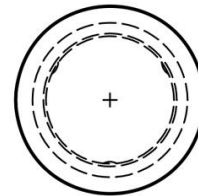
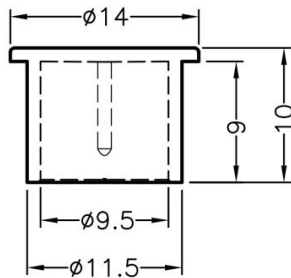

	PART NO	PACKAGE
	DZGR-06	1000

南京诺金电气有限公司

Nanjing Nowking Electric Co., Ltd



产品名称：端子盖

规格型号：DZGR-07

◆ MATERIAL: PP(UL)

◆ FLAME CLASS:94HB

◆ COLOR:BLACK

◆ UNIT: mm

用途：用于端子之防尘与保护。

DZGR-07 结构图

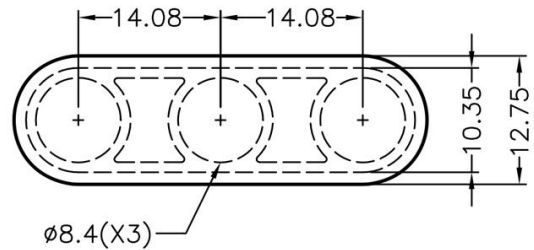
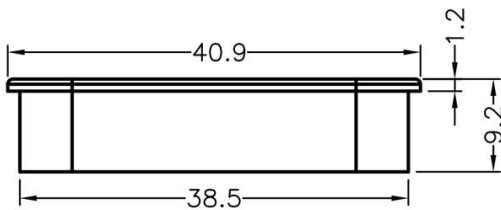

	PART NO	PACKAGE
	DZGR-07	1000

南京诺金电气有限公司

Nanjing Nowking Electric Co., Ltd

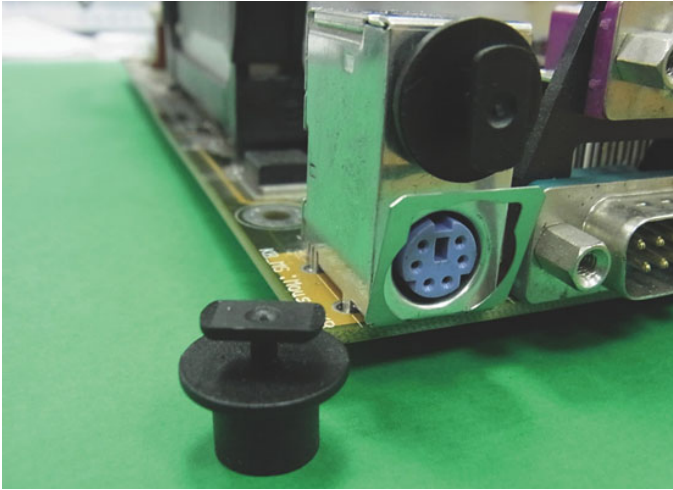

产品名称：端子盖

规格型号：DZGR-08

◆ MATERIAL: PP(UL)

◆ COLOR: BLACK

◆ UNIT: mm

用途：用于端子之防尘与保护。

所有尺寸量测皆不含进胶口,胶口凸出 0.3mm 之内

DZGR-08 结构图

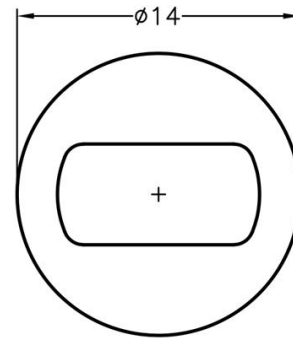
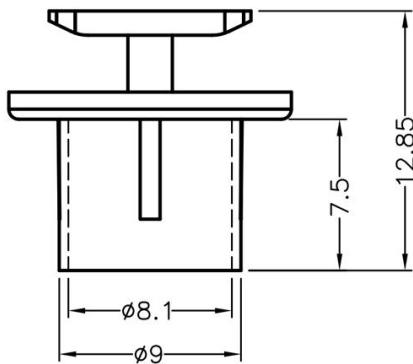

	PART NO	PACKAGE
	DZGR-08	1000

南京诺金电气有限公司

Nanjing Nowking Electric Co., Ltd

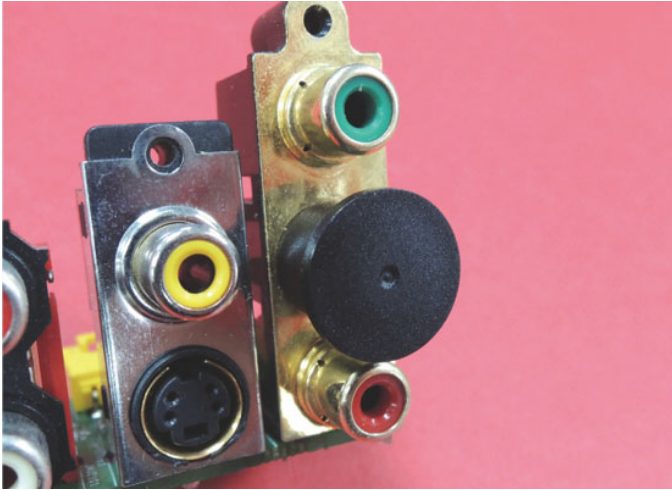

产品名称：端子盖

规格型号：DZGR-09

- ◆ MATERIAL: NYLON 66(UL)
- ◆ FLAME CLASS: 94V-0, 94V-2
- ◆ COLOR: BLACK, NATURAL
- ◆ UNIT: mm

用途：用于 RCA 连接器之防尘与保护。

DZGR-09 结构图

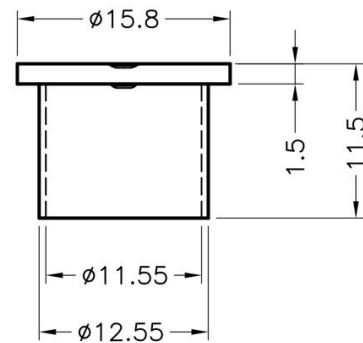
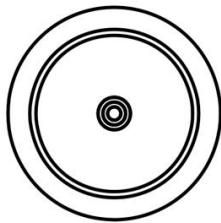

	PART NO	PACKAGE
	DZGR-09	1000

南京诺金电气有限公司

Nanjing Nowking Electric Co., Ltd



产品名称：端子盖

规格型号：DZGR-10

◆ MATERIAL: PE

◆ COLOR: TRANSPARENT

◆ UNIT: mm

用途：用于端子之防尘与保护用。

可使用同等材质

DZGR-10 结构图

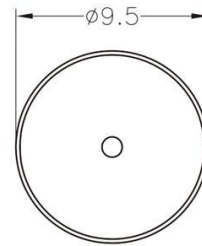
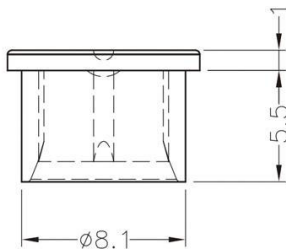

	PART NO	PACKAGE
	DZGR-10	1000

南京诺金电气有限公司

Nanjing Nowking Electric Co., Ltd

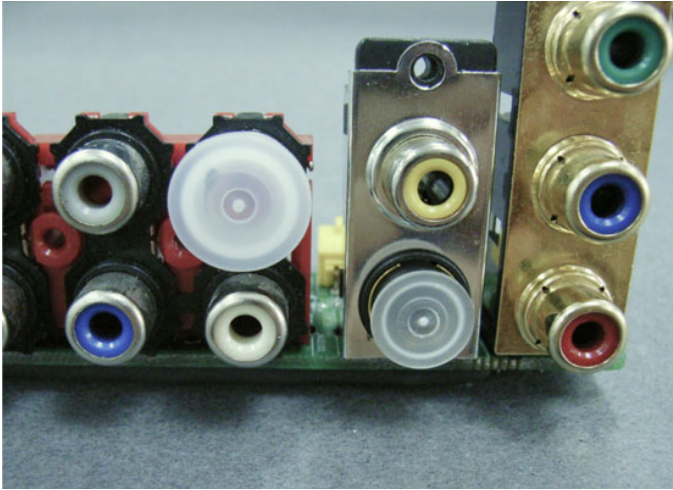

产品名称：端子盖

规格型号：DZGR-11

◆ MATERIAL: PE

◆ COLOR: NATURAL

◆ UNIT: mm

用途：用于连接器(RCA 端子)之防尘，保护用。

所有尺寸量测皆不含进胶口,胶口凸出 0.3mm 之内

DZGR-11 结构图

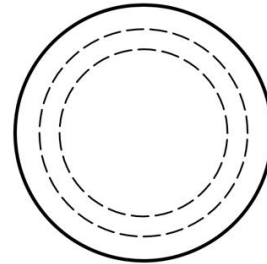
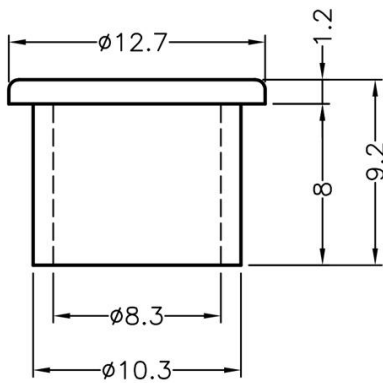

	PART NO	PACKAGE
	DZGR-11	1000