

南京诺金电气有限公司

Nanjing Nowking Electric Co., Ltd

垫圈样本

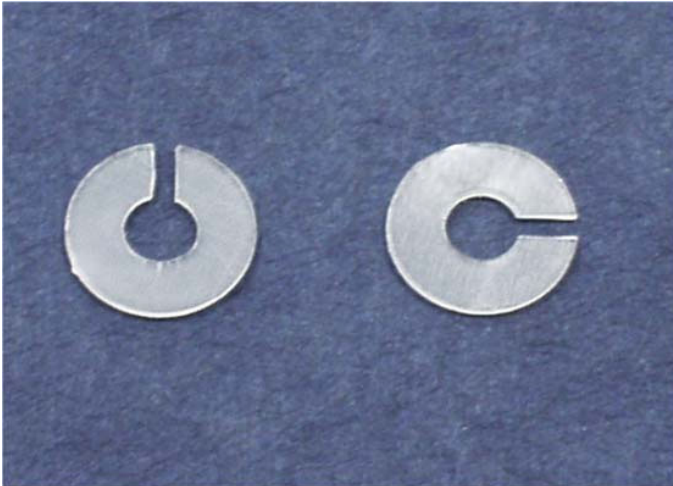

产品名称：垫圈

规格型号：COCS-01

- ◆ MATERIAL: NYLON 66(UL)
- ◆ FLAME CLASS: 94V-2, 94HB
- ◆ COLOR: BLACK, NATURAL
- ◆ UNIT: mm

用途：做为零件之垫片。

COCS-01 结构图

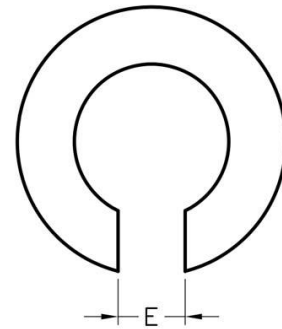
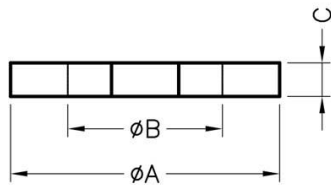

	PART NO	A	B	C	E	PACKAGE
	COCS-01	4.0	2.3	0.5	1.0	2000

南京诺金电气有限公司

Nanjing Nowking Electric Co., Ltd

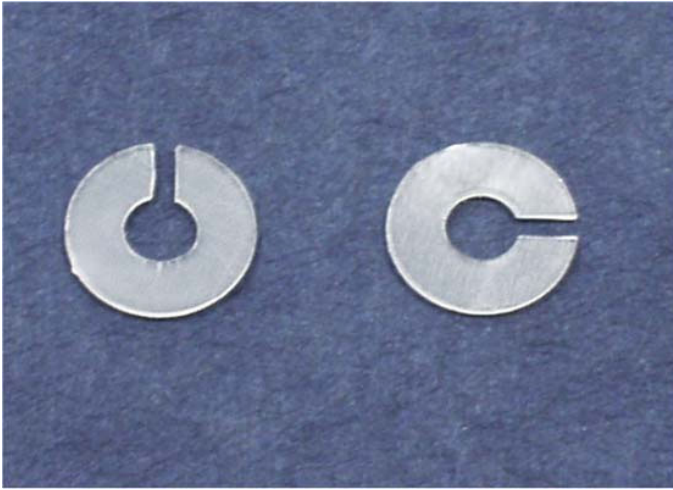

产品名称：垫圈

规格型号：COCS-02

◆ MATERIAL: NYLON 66(UL)

◆ FLAME CLASS: 94V-2, 94HB

◆ COLOR: BLACK, NATURAL

◆ UNIT: mm

用途：做为零件之垫片。

COCS-02 结构图

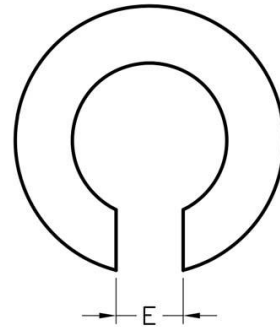
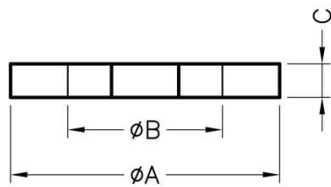

	PART NO	A	B	C	E	PACKAGE
	COCS-02	6.0	3.0	1.0	1.0	2000

南京诺金电气有限公司

Nanjing Nowking Electric Co., Ltd

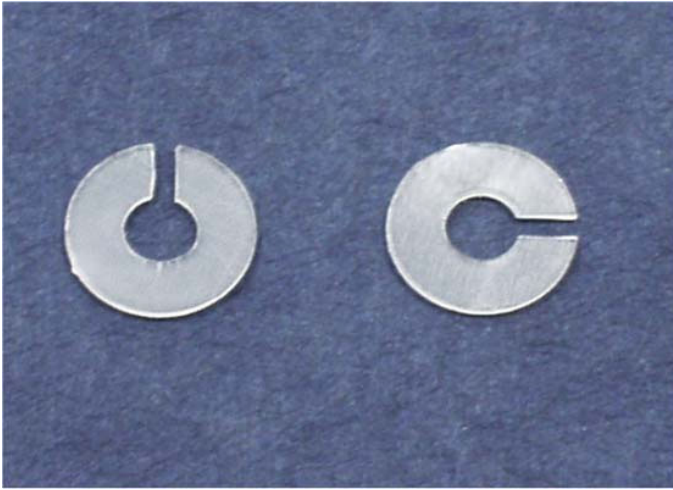

产品名称：垫圈

规格型号：COCS-03

◆ MATERIAL 1: NYLON 66(UL)

◆ FLAME CLASS: 94V-2, 94HB

◆ COLOR: BLACK, NATURAL

◆ MATERIAL 2: PC(UL)

◆ UNIT: mm

用途：做为零件之垫片。

COCS-03 结构图

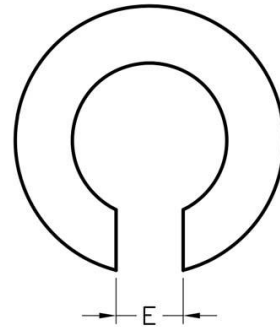
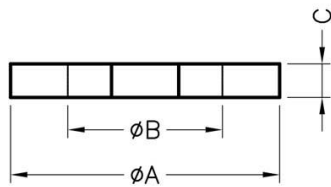

	PART NO	A	B	C	E	PACKAGE
	COCS-03	8.0	5.0	4.0	2.5	1000

南京诺金电气有限公司

Nanjing Nowking Electric Co., Ltd



产品名称：垫圈

规格型号：COCS-04

- ◆ MATERIAL 1: PC 66(UL)
- ◆ FLAME CLASS: 94V-2, 94V-0
- ◆ COLOR: NATURAL
- ◆ UNIT: mm

用途：作为螺丝之垫片。

COCS-04 结构图

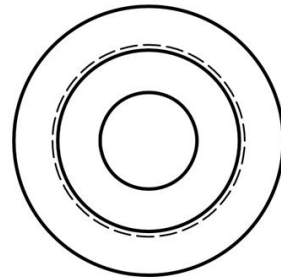
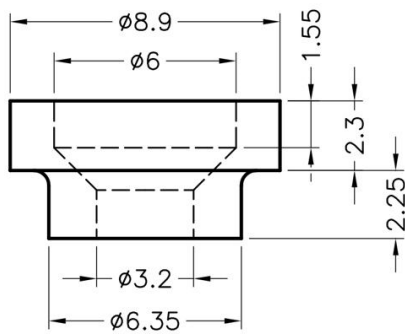

	PART NO	PACKAGE
	COCS-04	2000

南京诺金电气有限公司

Nanjing Nowking Electric Co., Ltd



产品名称：垫圈

规格型号：COCS-05

- ◆ MATERIAL 1: ABS(UL)
- ◆ FLAME CLASS:94HB
- ◆ COLOR:.,NATURAL,WHITE
- ◆ UNIT: mm

用途：配合螺丝使用作垫片。

COCS-05 结构图

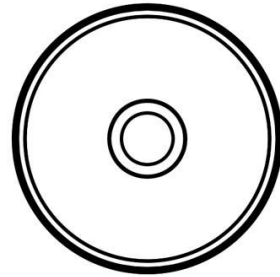
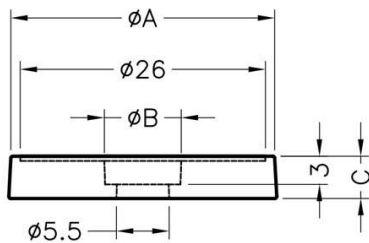

	PART NO	A	B	C	PACKAGE
	COCS-05	28.0	8.0	4.5	1000

南京诺金电气有限公司

Nanjing Nowking Electric Co., Ltd

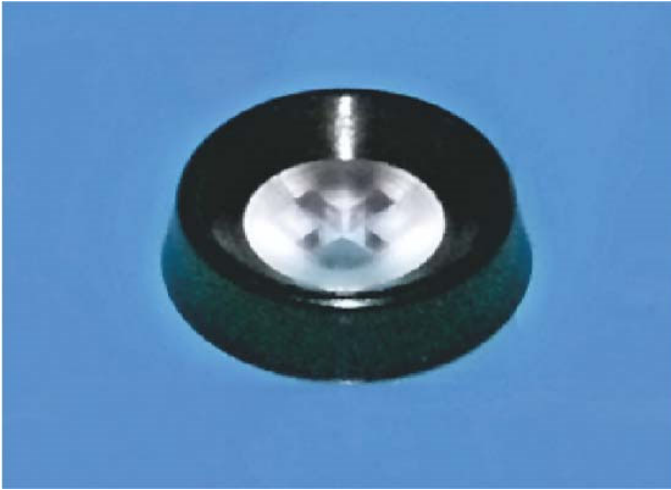

产品名称: 垫圈

规格型号: COCS-06

- ◆ MATERIAL 1: NYLON 66(UL)
- ◆ FLAME CLASS: 94V-0, 94V-2
- ◆ COLOR: NATURAL, BLACK
- ◆ UNIT: mm

用途: 配合螺丝使用作垫片。

COCS-06 结构图

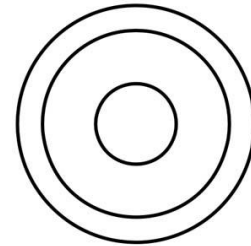
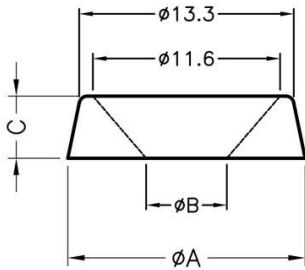

	PART NO	A	B	C	PACKAGE
	COCS-06	14.7	5.0	3.85	2000

南京诺金电气有限公司

Nanjing Nowking Electric Co., Ltd



产品名称：垫圈

规格型号：COCS-07

- ◆ MATERIAL : POM(UL)
- ◆ FLAME CLASS:94HB
- ◆ COLOR:.,NATURAL,BLACK
- ◆ UNIT: mm

用途：配合螺丝使用作垫片。

COCS-07 结构图

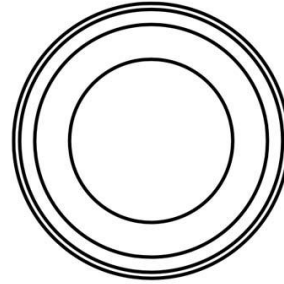
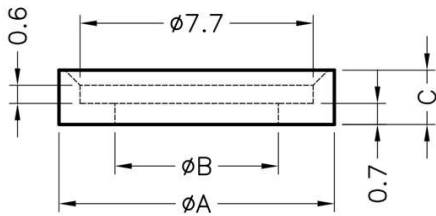

	PART NO	A	B	C	PACKAGE
	COCS-07	9.1	5.4	1.8	2000

南京诺金电气有限公司

Nanjing Nowking Electric Co., Ltd



产品名称：垫圈

规格型号：COCS-08

◆ MATERIAL 1: NYLON 66(UL)

◆ FLAME CLASS:94V-2,94V-0

◆ COLOR:.,NATURAL,BLACK

◆ UNIT: mm

用途：作为零件之垫片。

可使用同等材质

所有尺寸量测皆不含进胶口,胶口凸出 0.3mm 之内

COCS-08 结构图

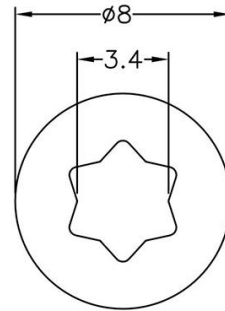
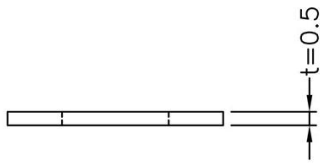

	PART NO	PACKAGE
	COCS-08	1000

南京诺金电气有限公司

Nanjing Nowking Electric Co., Ltd



产品名称：垫圈

规格型号：COCS-09

◆ MATERIAL : POM

◆ COLOR:BLACK

◆ UNIT: mm

用途：作为零件之垫片。

可使用同等材质

所有尺寸量测皆不含进胶口,胶口凸出 0.3mm 之内
内缩为正常现象

COCS-09 结构图

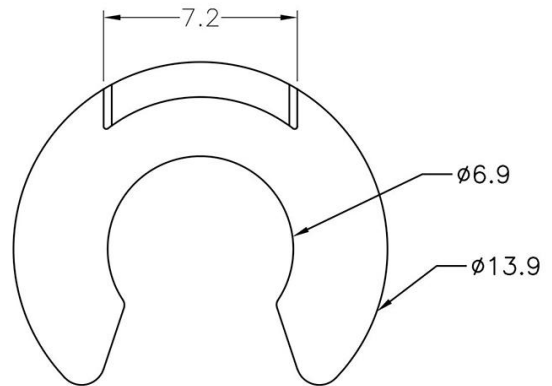
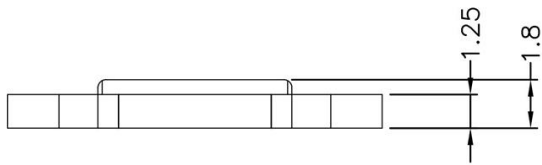

	PART NO	PACKAGE
	COCS-09	1000

南京诺金电气有限公司

Nanjing Nowking Electric Co., Ltd



产品名称：垫圈

规格型号：COCS-10

- ◆ MATERIAL : NYLON 66(UL)
- ◆ FALME CLASS:94V-0, 94V-2
- ◆ COLOR:BLACK,NATURAL
- ◆ UNIT: mm

用途：作为零件之垫片。

可使用同等材质

所有尺寸量测皆不含进胶口,胶口凸出 0.3mm 之内
内缩为正常现象

COCS-10 结构图

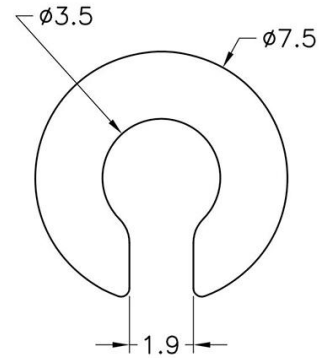

	PART NO	PACKAGE
	COCS-10	1000