

# 南京诺金电气有限公司

## Nanjing Nowking Electric Co., Ltd

电源插座防尘盖样本

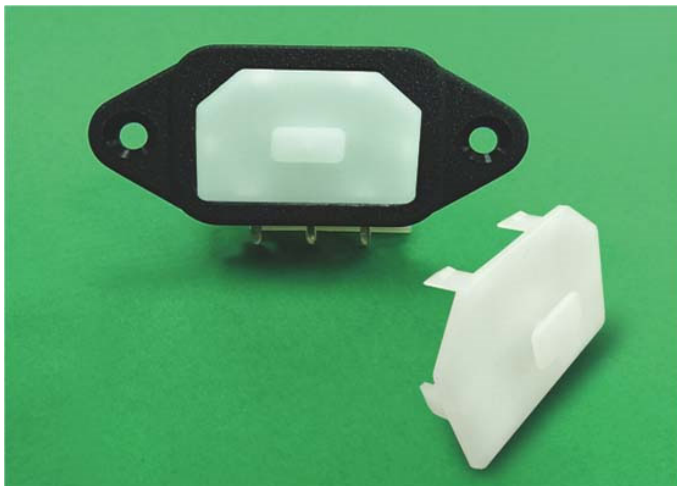

产品名称：电源插座防尘盖

规格型号：KLCB01

- ◆ MATERIAL: NYLON 66(UL)
- ◆ FLAME CLASS: 94V-2, 94V-0
- ◆ COLOR: BLACK, NATURAL
- ◆ UNIT: mm

用途：用于电源座之防尘与保护。

KLCB01 结构图

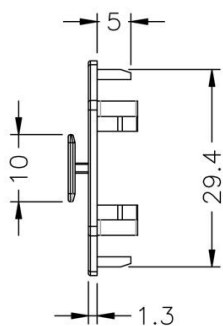
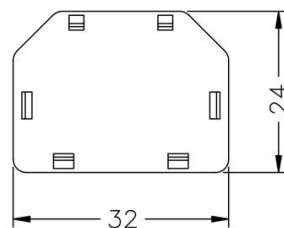
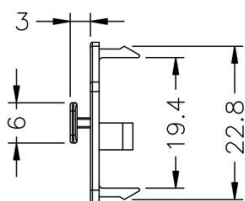

	PART NO	PACKAGE
	KLCB01	500

# 南京诺金电气有限公司

## Nanjing Nowking Electric Co., Ltd



产品名称：电源插座防尘盖

规格型号：KLCB02

- ◆ MATERIAL: PE+EVA
- ◆ FLAME CLASS: 94V-2, 94V-0
- ◆ COLOR: YELLOW
- ◆ UNIT: mm

用途：用于电源座接头防尘与保护。

KLCB02 结构图

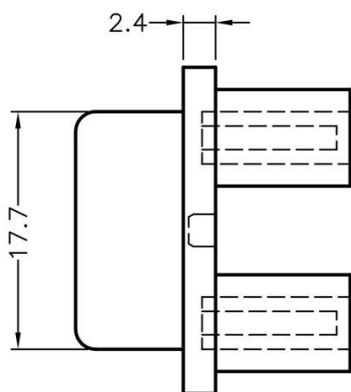
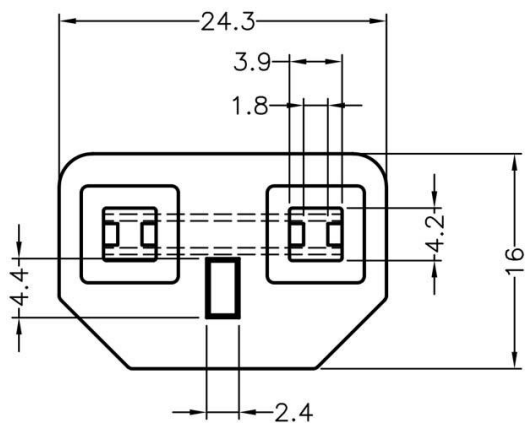
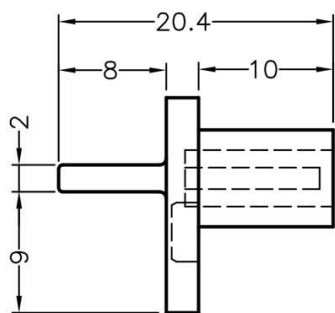

PART NO	PACKAGE
KLCB02	250

# 南京诺金电气有限公司

## Nanjing Nowking Electric Co., Ltd

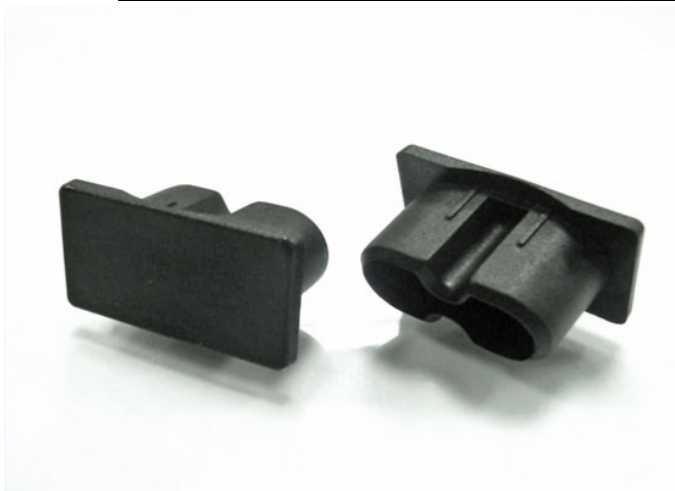

产品名称：电源插座防尘盖

规格型号：KLCB03

- ◆ MATERIAL: NYLON 66(UL)
- ◆ FLAME CLASS: 94V-2, 94V-0
- ◆ COLOR: BLACK, NATURAL
- ◆ UNIT: mm

用途：用于电源座接头防尘与保护。

KLCB03 结构图

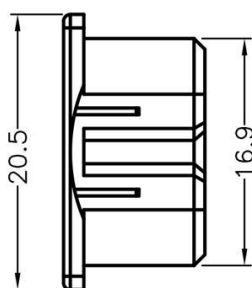
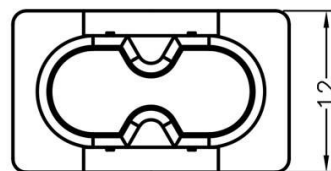
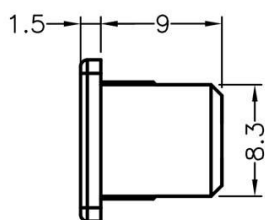

	PART NO	PACKAGE
	KLCB03	500

# 南京诺金电气有限公司

## Nanjing Nowking Electric Co., Ltd



产品名称：电源插座防尘盖

规格型号：KLCB04

- ◆ MATERIAL: NYLON 66(UL)
- ◆ FLAME CLASS: 94V-2, 94V-0
- ◆ COLOR: BLACK, NATURAL
- ◆ UNIT: mm

用途：用于电源座接头防尘与保护。

KLCB04 结构图

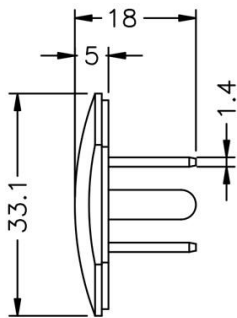
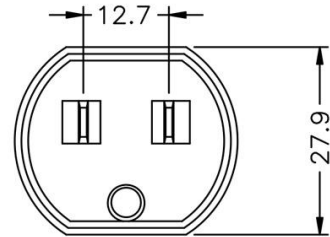
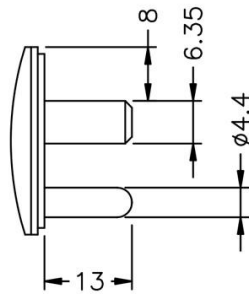

	PART NO	PACKAGE
	KLCB04	500

# 南京诺金电气有限公司

## Nanjing Nowking Electric Co., Ltd



产品名称：电源插座防尘盖

规格型号：KLCB05

◆ MATERIAL: PP

◆ COLOR: WHITE

◆ UNIT: mm

用途：用于两插电源座防尘与保护用。

KLCB05 结构图

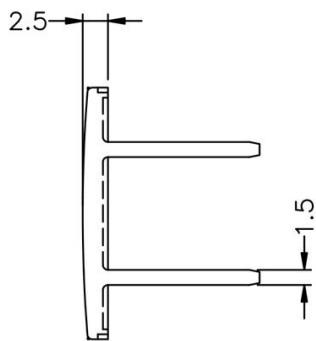
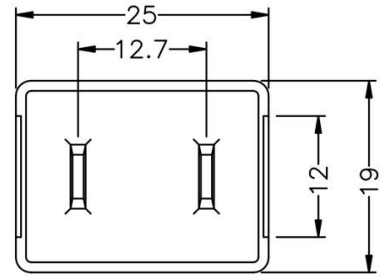
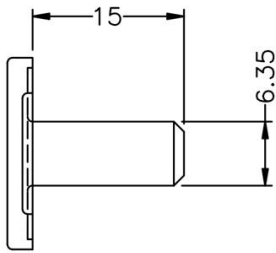

	PART NO	PACKAGE
	KLCB05	500

# 南京诺金电气有限公司

## Nanjing Nowking Electric Co., Ltd



产品名称：电源插座防尘盖

规格型号：KLCB06

- ◆ MATERIAL: TPE(UL)
- ◆ FLAME CLASS: 94V-0
- ◆ COLOR: BLACK,YELLOW
- ◆ UNIT: mm

用途：用于电源座接头防尘与保护。

可使用同等材质

KLCB06 结构图

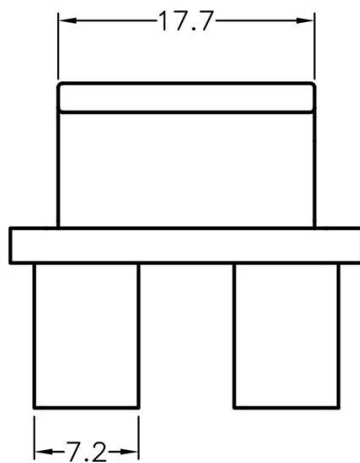
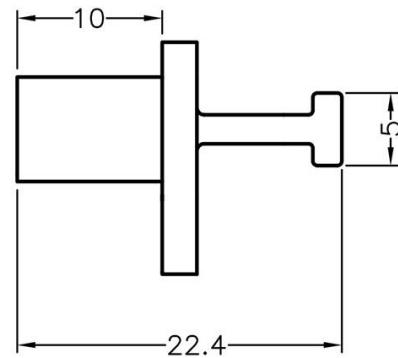
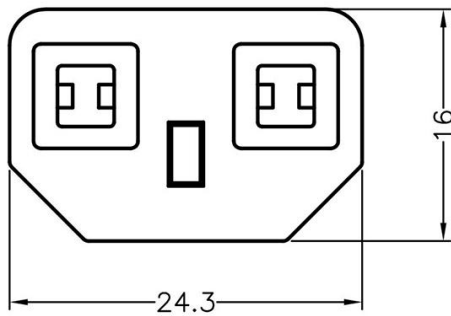

	PART NO	PACKAGE
	KLCB06	250

# 南京诺金电气有限公司

## Nanjing Nowking Electric Co., Ltd

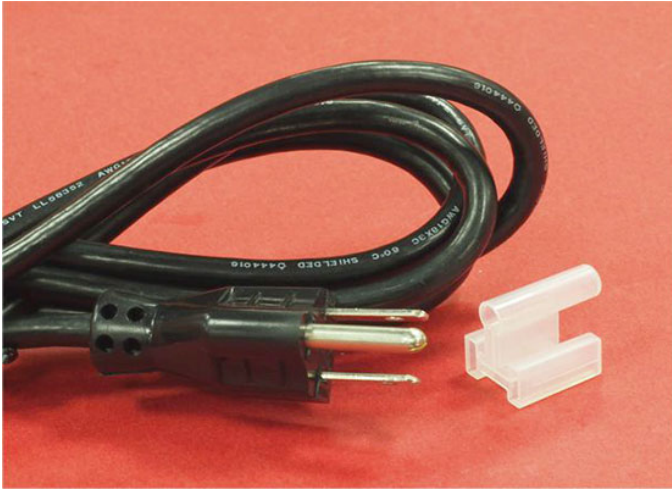

产品名称：电源插座防尘盖

规格型号：KLCB07

◆ MATERIAL: PE

◆ COLOR: NATURAL

◆ UNIT: mm

用途：保护电源插头，防氧化。

可使用同等材质

KLCB07 结构图

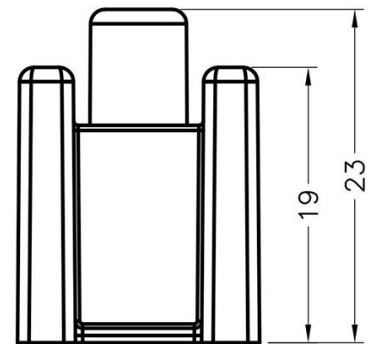
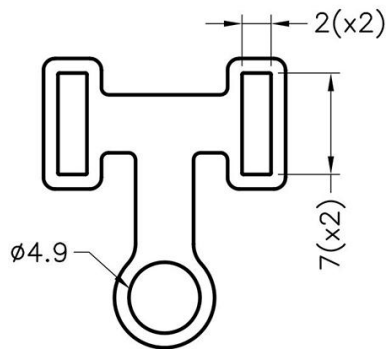

	PART NO	PACKAGE
	KLCB07	1000

# 南京诺金电气有限公司

## Nanjing Nowking Electric Co., Ltd

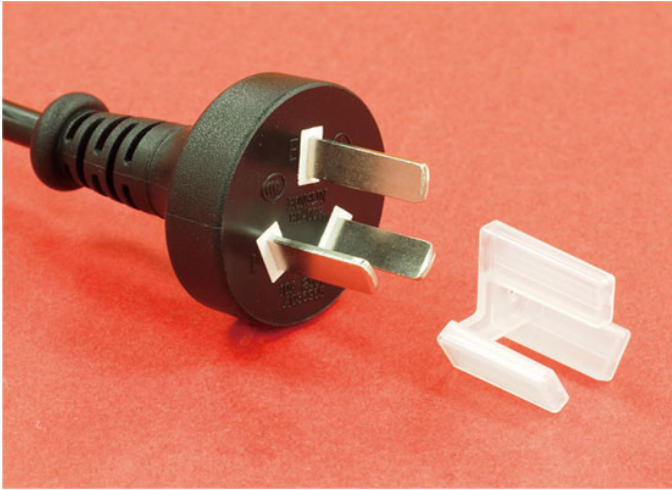

产品名称：电源插座防尘盖

规格型号：KLCB08

◆ MATERIAL: PE

◆ COLOR: NATURAL

◆ UNIT: mm

用途：保护电源插头，防氧化。

内缩为正常现象

可使用同等材质

KLCB08 结构图

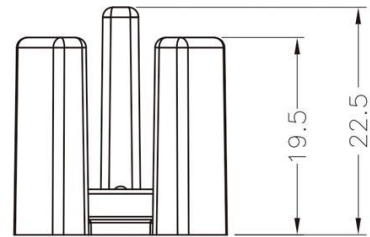
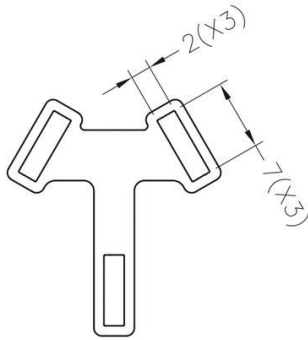

	PART NO	PACKAGE
	KLCB08	1000



# 南京诺金电气有限公司

## Nanjing Nowking Electric Co., Ltd



产品名称：电源插座防尘盖

规格型号：KLCB09

◆ MATERIAL: PE

◆ COLOR: BLACK

◆ UNIT: mm

用途：用于电源插座接头防尘与保护。

内缩为正常现象

可使用同等材质

KLCB09 结构图

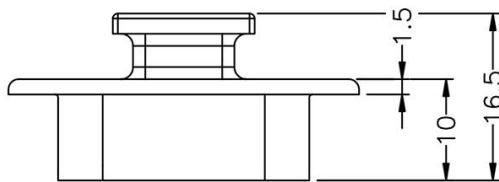
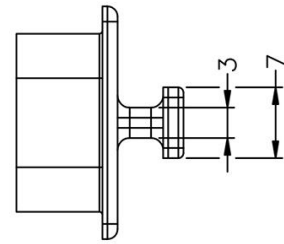
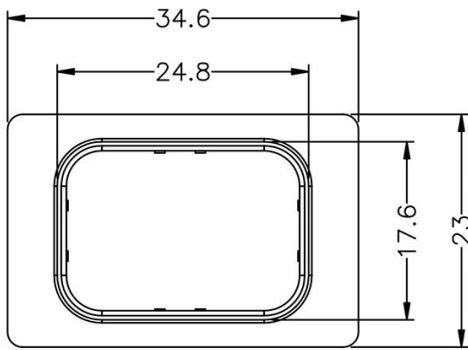

PART NO	PACKAGE
KLCB09	1000