

# 南京诺金电气有限公司

## Nanjing Nowking Electric Co., Ltd

弹片样本

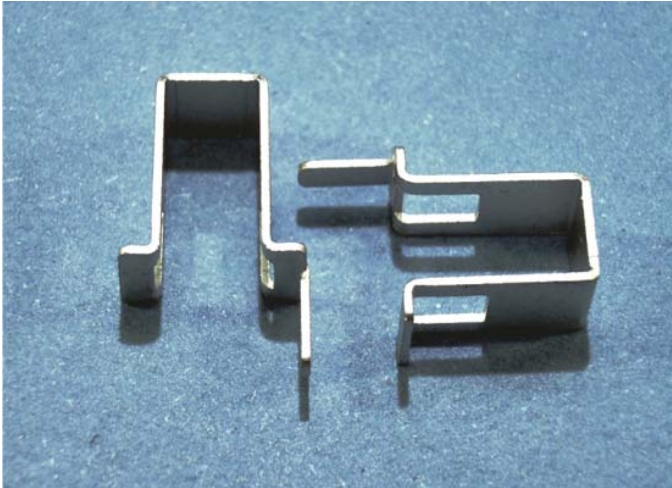

产品名称: 弹片

规格型号: TRNK-001

◆ MATERIAL: TIN PLATED SPCC

◆ UNIT: mm

用途: 作为导电弹片。

TRNK-001 结构图

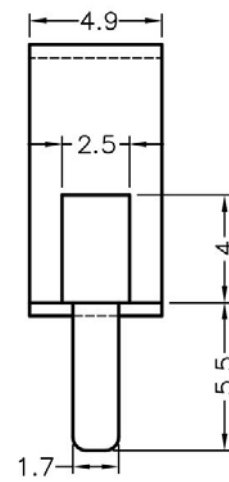
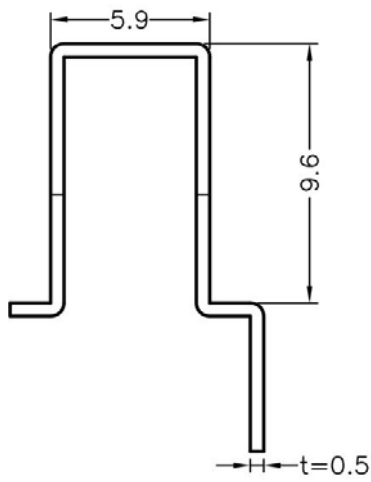

	PART NO	PACKAGE
	TRNK-001	1000

# 南京诺金电气有限公司

## Nanjing Nowking Electric Co., Ltd

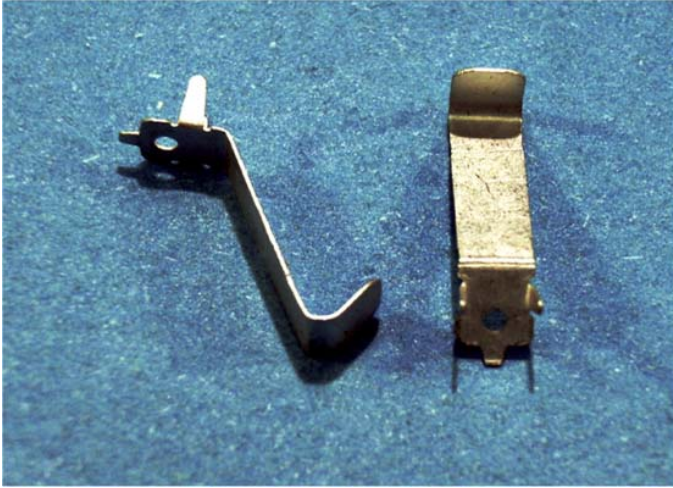

产品名称：弹片

规格型号：TRNK-002

◆ MATERIAL: TIN PLATED  
PHOSPHOR BRONZE

◆ UNIT: mm

用途: 作为导电弹片。

TRNK-002 结构图

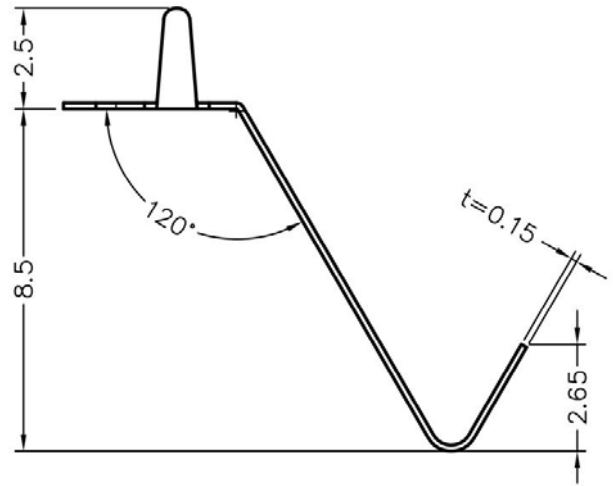
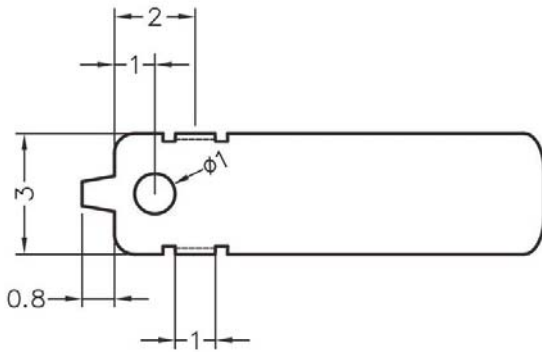

	PART NO	PACKAGE
	TRNK-002	2000

总机/TEL: +86 25 85437901 85422485 85436028  
[Http://www.nowking.com](http://www.nowking.com) E-mail: [nk@nowking.com](mailto:nk@nowking.com)  
 QQ: 260678075 WeChat: 13770725488

# 南京诺金电气有限公司

## Nanjing Nowking Electric Co., Ltd

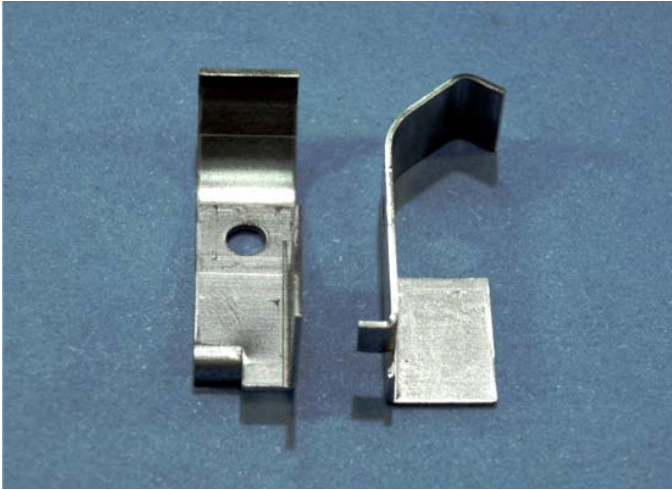

产品名称：弹片

规格型号：TRNK-003

◆ MATERIAL: SUS301

◆ UNIT: mm

用途：作为弹片使用，弹性佳。

TRNK-003 结构图

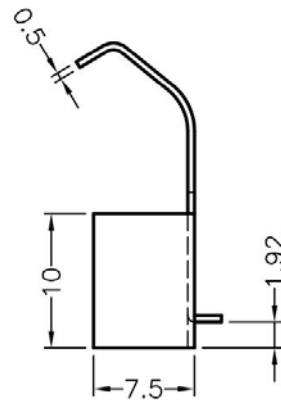
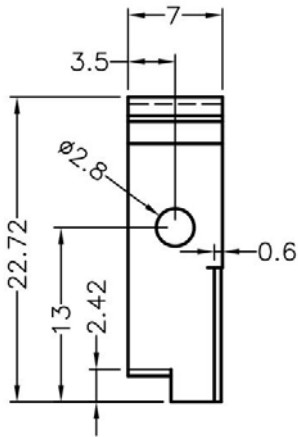

	PART NO	PACKAGE
	TRNK-003	1000

# 南京诺金电气有限公司

## Nanjing Nowking Electric Co., Ltd

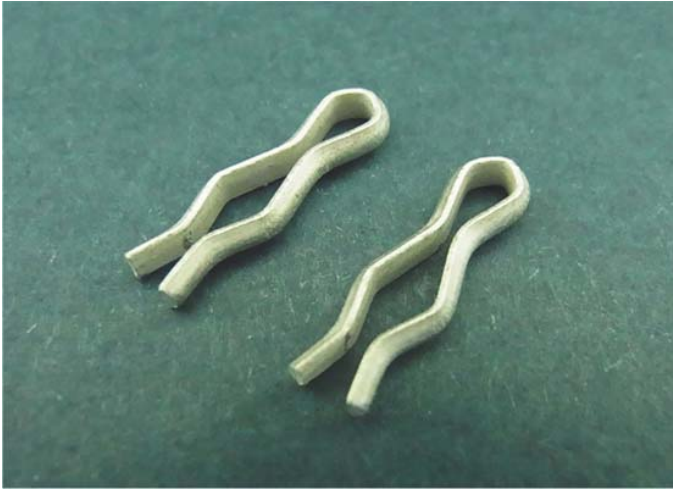

产品名称：弹片

规格型号：TRNK-004

◆ MATERIAL: TIN PLATED BRASS

◆ UNIT: mm

用途:作为弹片使用。

TRNK-004 结构图

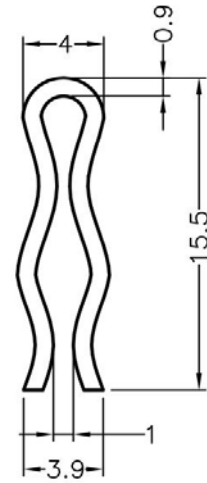
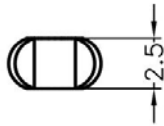

	PART NO	PACKAGE
	TRNK-004	1000

# 南京诺金电气有限公司

## Nanjing Nowking Electric Co., Ltd



产品名称：弹片

规格型号：TRNK-005

◆ MATERIAL:SK7 COATING-ZI

◆ UNIT: mm

用途::作为弹片使用。

TRNK-005 结构图

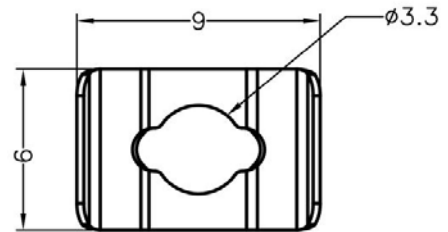
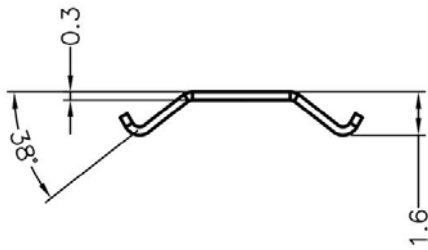

	PART NO	PACKAGE
	TRNK-005	1000