

# 南京诺金电气有限公司

## Nanjing Nowking Electric Co., Ltd

### PC 端子保护套

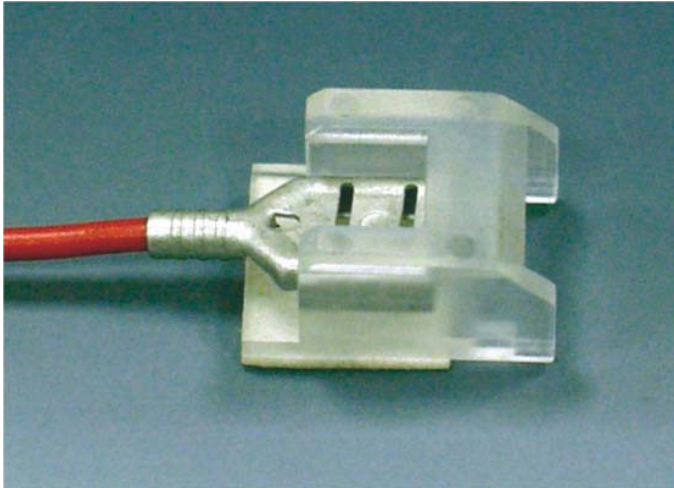

产品名称: PC 端子保护套

规格型号: PCDK-1

◆ MATERIAL:PC(UL)

◆ FLAME CLASS:94V-2

◆ COLOR:NATURAL

◆ UNIT:mm

用途: 用于电池端子之绝缘与保护。

PCDK-1 结构图

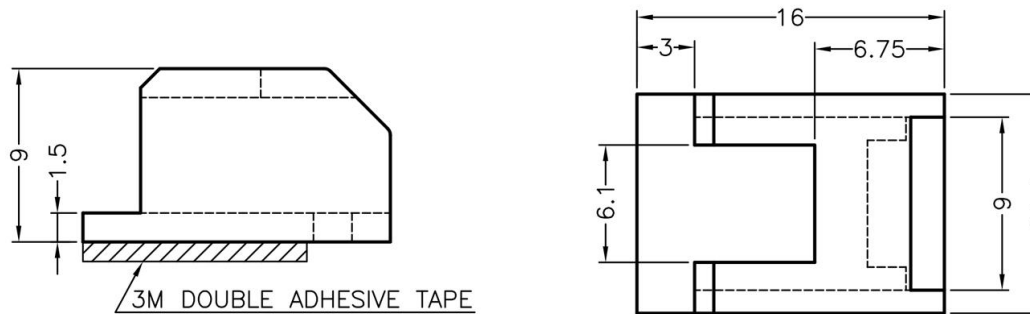

	PART NO	PACKAGE
	PCDK-1	1000

# 南京诺金电气有限公司

## Nanjing Nowking Electric Co., Ltd

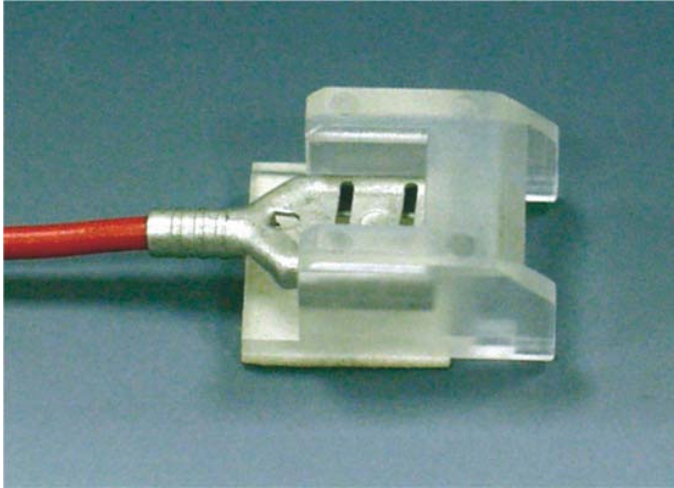

产品名称：PC 端子保护套

规格型号：PCDK-2

- ◆ MATERIAL:PC(UL)
- ◆ FLAME CLASS:94V-2
- ◆ COLOR:NATURAL
- ◆ UNIT:mm

用途：用于电池端子之绝缘与保护。

PCDK-2 结构图

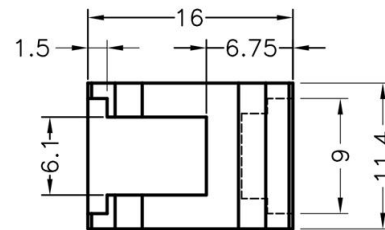
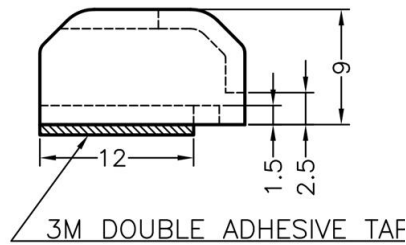

	PART NO	PACKAGE
	PCDK-2	1000

# 南京诺金电气有限公司

## Nanjing Nowking Electric Co., Ltd



产品名称：PC 端子保护套

规格型号：PCDK-3

◆ MATERIAL:PC(UL)

◆ FLAME CLASS:94V-2

◆ COLOR:NATURAL

◆ UNIT:mm

用途：用于电池端子之绝缘与保护。

PCDK-3 结构图

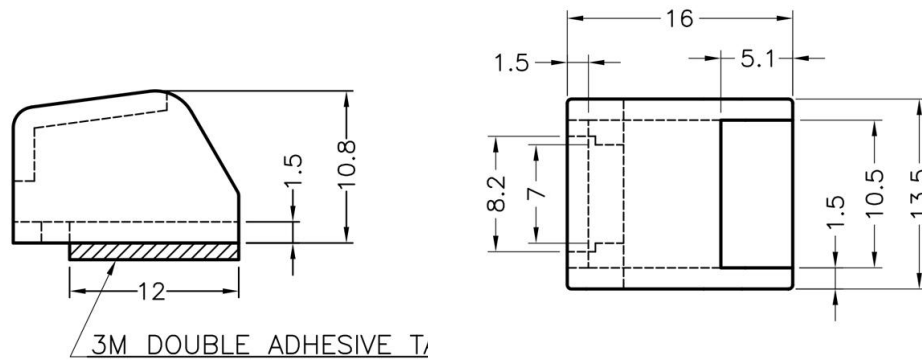

	PART NO	PACKAGE
	PCDK-3	1000

# 南京诺金电气有限公司

## Nanjing Nowking Electric Co., Ltd



产品名称：PC 端子保护套

规格型号：PCDK-4

◆ MATERIAL:PC(UL)

◆ FLAME CLASS:94V-2

◆ COLOR:NATURAL

◆ UNIT:mm

用途：用于电池端子之绝缘与保护。

PCDK-4 结构图

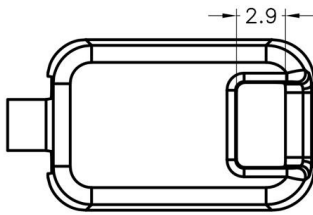
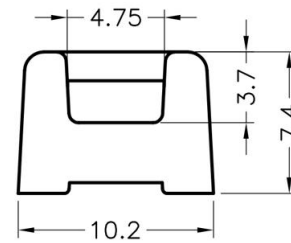
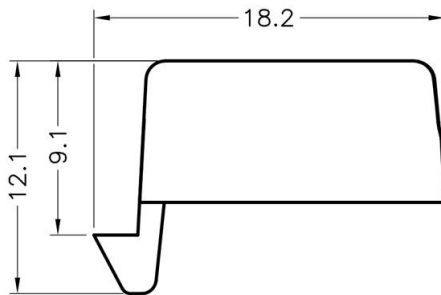

	PART NO	PACKAGE
	PCDK-4	1000