

PC板间隔柱 SPACER SUPPORT

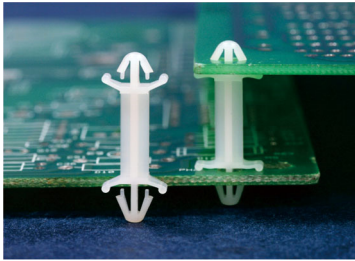

MATERIAL : NYLON 66(UL)
 FLAME CLASS : 94V-0,94V-2
 COLOR : BLACK,NATURAL
 UNIT: mm

用途： PC板与PC板间之固定，不占空间

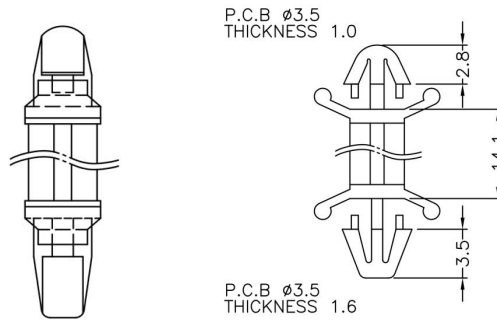

PART NO	PACKAGE
PCSS-043	1000

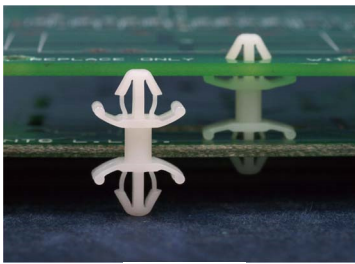

MATERIAL : NYLON 66(UL)
 FLAME CLASS : 94V-0,94V-2
 COLOR : BLACK,NATURAL
 UNIT: mm

用途： PC板与PC板间之固定，不占空间

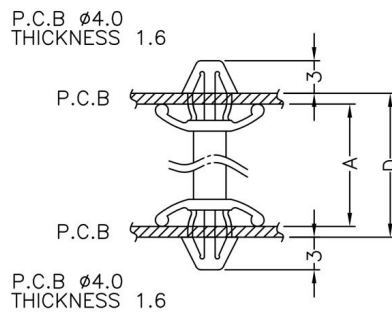

PART NO	A	D	PACKAGE
PCSS-044	6.0	9.2	1000
PCSS-045	8.0	11.2	1000
PCSS-046	10.0	13.2	1000
PCSS-047	12.0	15.2	1000
PCSS-048	13.0	16.2	1000
PCSS-049	14.0	17.2	1000
PCSS-050	16.0	19.2	1000
PCSS-051	16.8	20.0	1000
PCSS-052	18.0	21.2	1000
PCSS-053	20.0	23.2	1000
PCSS-1291	42.0	45.2	1000

6

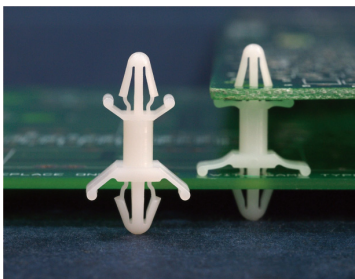

MATERIAL : NYLON 66(UL)
 FLAME CLASS : 94V-0,94V-2
 COLOR : BLACK,NATURAL
 UNIT: mm

用途： 固定PC板于机板上，免工具，易拆卸

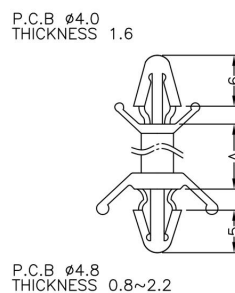

PART NO	A	PACKAGE
PCSS-054	3.8	1000
PCSS-055	4.6	1000
PCSS-056	6.3	1000
PCSS-057	7.93	1000
PCSS-058	9.2	1000
PCSS-059	12.5	1000
PCSS-060	15.7	1000
PCSS-061	19.0	1000
PCSS-062	22.0	1000
PCSS-063	25.4	1000
PCSS-064	28.6	1000

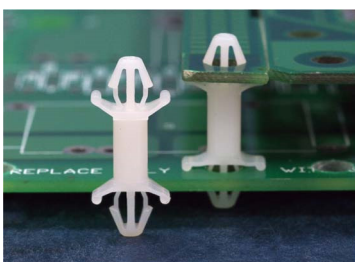

MATERIAL : NYLON 66(UL)
 FLAME CLASS : 94V-0,94V-2
 COLOR : BLACK,NATURAL
 UNIT: mm

用途： PC板与PC板间之固定，不占空间

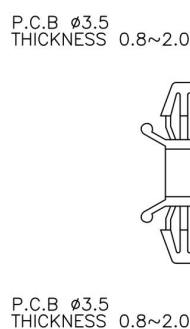

PART NO	A	PACKAGE
PCSS-065	2.1	2000
PCSS-066	2.2	2000
PCSS-067	4.8	2000
PCSS-068	7.0	2000
PCSS-069	10.0	2000
PCSS-070	12.7	2000
PCSS-071	14.0	2000
PCSS-072	17.0	2000